



JONNESWAY®

Ferramenta que nos une



*de profissionais
para profissionais*

2021



JONNESWAY®

Ferramentas Profissionais Manuais e Pneumáticas



Este catálogo anula e substitui todas as edições anteriores.
Todos os preços apresentados nesta tabela estão sujeitos a IVA à taxa legal em vigor.

A Jonnesway está em constante desenvolvimento dos seus produtos, portanto, os modelos, composições, características técnicas, físicas, design e preços podem ser alterados, substituídos ou mesmo retirados deste catálogo sem aviso prévio e sem obrigação de efetuar qualquer alteração nas ferramentas e/ou equipamentos vendidos anteriormente. As capacidades indicadas para os produtos, são as que resultaram dos ensaios realizados nos laboratórios da Jonnesway, não sendo portanto contratuais.



www.jonneswaytools.com



facebook.com/jonneswaytools



Lusilectra
Salvador Caetano

Catálogo versão 3.4 Portugal
Entra em vigor em janeiro de 2021

Carros e Composições de Ferramentas	Carros e composições de ferramentas	5-17
	Armários e carros para ferramentas	18-22
	Malas vazias e complementos para carros	23-25
Ferramenta Manual	Tabuleiros de ferramenta	27-43
	Ferramenta de aperto	44-85
	Alicates	86-93
	Chaves	94-106
	Martelos	107
	Diversos	108-111
	Ferramenta isolada a 1 000V	112-116
	Ferramenta Especial Mecânica	Mecânica
Motociclos		148-150
Chapeiro		150-154
Pesados		155
Acessórios		156
Ferramenta Pneumática	Ferramenta pneumática	157-175
	Acessórios para redes de ar comprimido	176-178
Merchandising	Merchandising	179-183
Outros Equipamentos	Outros equipamentos	185-189





JONNESWAY®

Ferramentas Profissionais
• Manuais • Pneumáticas •
específicas para automóvel, motociclos e pesados





JONNESWAY®

Carros e Composições de Ferramentas



**Carros e
composições
de ferramentas**

**Malas vazias
e acessórios
para carros**



**Armários e
carros para
ferramentas**

As suas necessidades ...



... a nossa solução!

Desenvolvemos soluções exclusivas para si!

EVA POWER

Carro com composição de ferramentas em **Tabuleiros EVA**

TABULEIROS

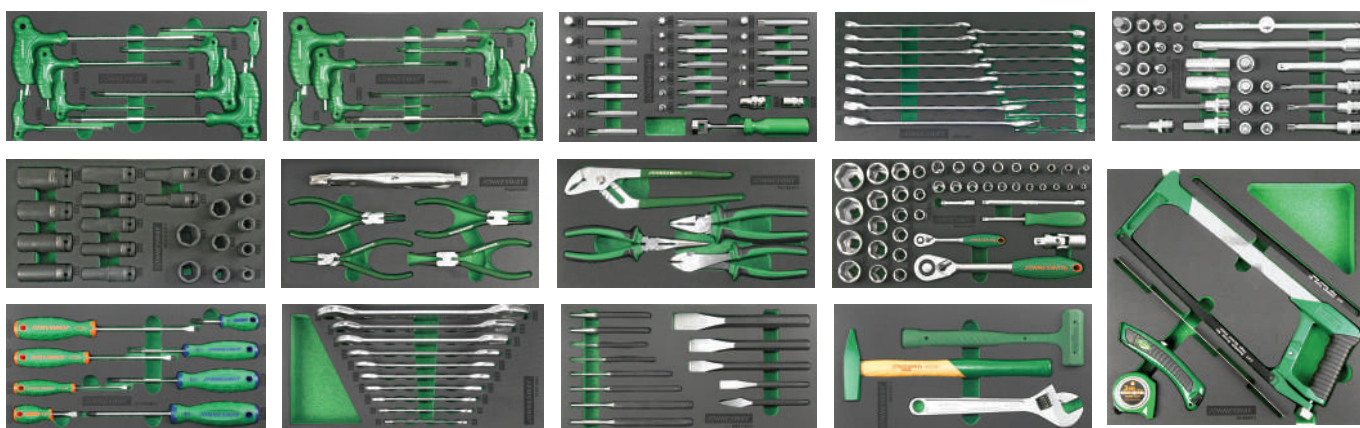

Composição:

- S04H4144KV Jogo de chaves de caixa com roquete de 1/2" e 1/4" com 44 peças
- S04H2132KV Jogo de chaves de vela, extensões e bits com 32 peças
- W26116KV Jogo de chaves mistas com 16 peças
- S03A4122KV Jogo de chaves de impacto de 1/2" com 22 peças
- M63113KV Jogo de punções, saca troços e talhadeiras com 13 peças
- D71PP08KV Jogo de chaves de fenda/ phillips com 8 peças
- W25110KV Jogo de chaves de bocas com 10 peças

- P011804KV Jogo de alicates com 4 peças
- S29H4141KV Jogo com chave de travões e bits com 41 peças
- H10MB08KV Jogo de chaves hexagonais de punho com 8 peças
- H10MT08KV Jogo de chaves torx de punho com 8 peças
- M09103KV Jogo de martelos com 3 peças
- P32M105KV Jogo de alicates de freios com 5 peças
- MHS08KV Jogo com serra, régua, x-ato e fita métrica

CARROS



C-6DWB1



C-7DC2B



EVA POWER-V	Cor: verde 	1 600.00€
EVA POWER-C	Cor: cinza 	1 600.00€

EVA POWER BLACK	Cor: preto 	1 365.00€
EVA POWER GREEN	Cor: verde 	1 365.00€

MEC SOLUTION

Carro de ferramentas com composição flexível, ajustável às suas necessidades

Adicione **3 TABULEIROS EVA**, sendo **1 do TIPO A** e **2 do TIPO B** e finalmente escolha o carro que vá de encontro das suas necessidades

TABULEIROS TIPO

A



S04H42165SV

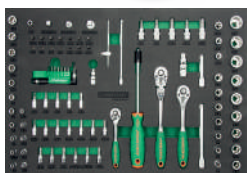

S04H3194SV

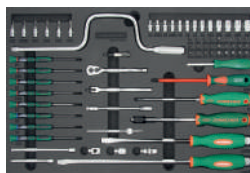

S04H2184SV



S04H4295SV

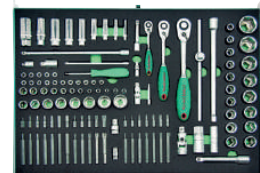

S04H46121SV

TABULEIROS TIPO

B



W2623431SV

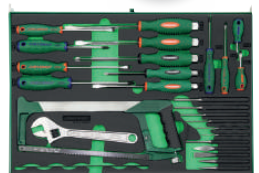

D737128SV



H10121SV



D737134SV



P82736SV



P82714SV

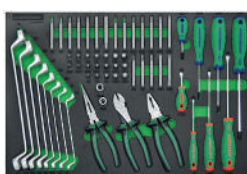

W23559SV

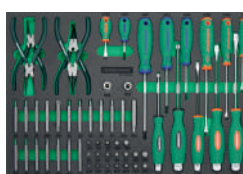

D71157SV



W26134SV

A



B



B



CARRO

CARROS

CARRO



C-6DWB1



C-7DC2B



MEC SOLUTION-V	Cor: verde		1 270.00€
MEC SOLUTION-C	Cor: cinza		1 270.00€

MEC SOLUTION BLACK	Cor: preto		1 205.00€
MEC SOLUTION GREEN	Cor: verde		1 205.00€

POWER LINE

Carro com composição de ferramentas universal para mecânico auto ou técnico de manutenção industrial

TABULEIROS



Composição:

Jogo 4 alicates de freios
 Jogo 3 alicates (universal/ pontas/ corte)
 Jogo 2 martelos e cinzeis
 Jogo 8 chaves fenda/ philips
 Jogo 9 chaves macho hexagonal

Jogo 8 chaves torx dupla punho
 Jogo serra, punções e chave inglesa
 Jogo alicate pressão e alicate ajustável
 Jogo chaves caixa com roquete 1/4"
 Jogo chaves caixa com roquete 1/2"

Jogo bits caixa 1/2" e 3/8"
 Jogo bits 1/2" e 3/8"
 Jogo 10 chaves de bocas
 Jogo 16 chaves mistas
 Jogo 8 chaves luneta 75°

CARROS





C-6DWB1



C-7DC2B

MEC POWER 19V	Cor: verde		1 370.00€
MEC POWER 19C	Cor: cinza		1 370.00€

BLACK POWER 19	Cor: preto		1 140.00€
GREEN POWER 19	Cor: verde		1 140.00€



MEC PROF-20

Carro de ferramentas para mecânico

TABULEIROS

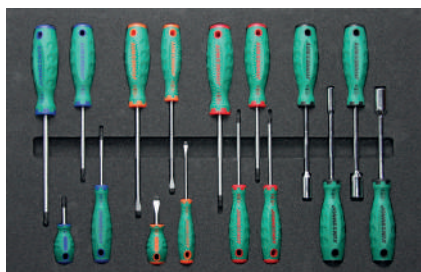
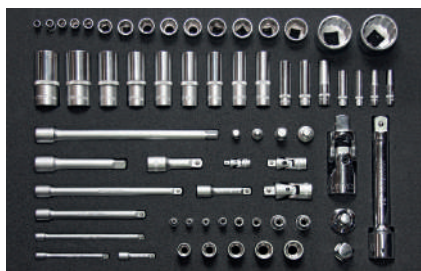

Composição: 271 peças

Tabuleiro com

Jogo chaves de caixa longa 1/4" e 1/2" de 6 a 27mm
 Jogo chaves de caixa 1/4", 1/2" e 3/4" de 6 a 36mm
 Jogo extensões de 1/4", 1/2" e 3/4"
 Adaptadores
 Cardans
 Jogo chaves de caixa torx de 1/4" e 1/2" de E5 a E 24

Tabuleiro com

Jogo chaves luneta de 10 a 22mm
 Jogo alicates de pontas pequenos
 Jogo de chaves de hexagonais curtas
 Apalpa folgas
 Martelo pena esférica
 Chave inglesa

Tabuleiro com

Jogo chaves mistas de 6 a 34mm

Tabuleiro com

Jogo chaves fenda, Philips e torx com punho
 Chave de caixa com punho

Tabuleiro com

Jogo alicates longos, universal, pontas, corte, pressão, ajustável
 Chave de filtros

Tabuleiro com

Jogo de roquetes 1/4", 3/4", 1/2", 3/8"
 Roquete extensível de 1/2"
 Jogo bits curtos e longos 1/2"
 Jogo chaves de caixa torx de 1/2"
 Jogo chaves ribe de 1/2"
 Jogo chaves estriadas de 1/2"
 Jogo de chaves de hexagonais 1/2"

CARROS



C-6DWB1



C-7DC2B



MEC PROF20-V	Cor: verde		1 800.00€
MEC PROF20-C	Cor: cinza		1 800.00€

MEC PROF20-BLACK	Cor: preto		1 635.00€
MEC PROF20-GREEN	Cor: verde		1 635.00€

ELECTR. 1000volts

Carro de electricista com composição de ferramenta isolada a 1 000volts

TABULEIROS

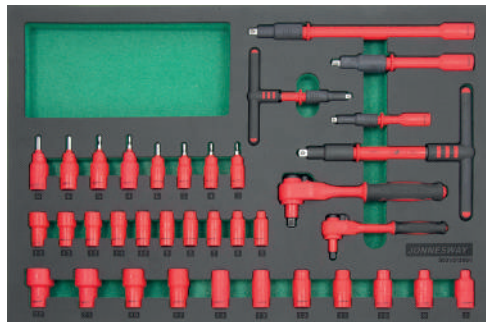
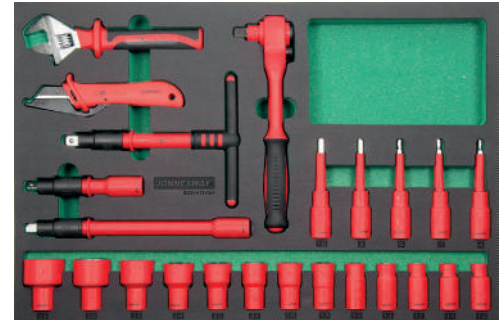
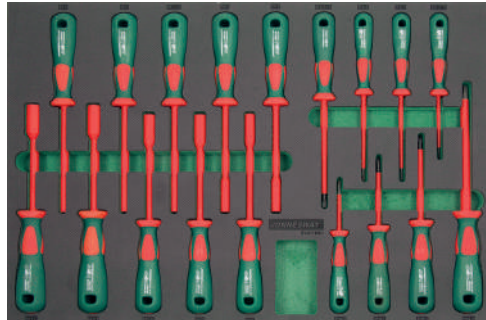

Composição:

Tabuleiro com 18 chaves isoladas

- 4 Chaves de fenda
- 4 Chaves phillips
- 10 Chaves de caixa de punho

Tabuleiro com 36 peças 1/4" e 3/8"

- 2 Roquete 1/4" e 3/8"
- 2 Cabo T de 1/4" e 3/8"
- 1 Extensão 100mm de 1/4"
- 10 Chaves de caixa 1/4"
- 4 Bits de caixa 1/4"
- 2 Extensões 3/8"
- 11 Chaves de caixa 3/8"
- 4 Bits de caixa 3/8"

Tabuleiro com 24 peças 1/2"

- 1 Roquete
- 1 Cabo T
- 2 Extensões
- 13 Chaves de caixa
- 5 Bits de caixa
- 1 Chave inglesa
- 1 X-ato

Tabuleiro com 25 peças

- 9 Chaves de bocas
- 13 Chaves de luneta
- 1 Alicate universal
- 1 Alicate de corte
- 1 Alicate de pontas

CARROS



C-6DWB1



C-7DC2B

ELECTR. 1000-V	Cor: verde	2 020.00€
ELECTR. 1000-C	Cor: cinza	2 020.00€

ELECTR. 1000 BLACK	Cor: preto	1 850.00€
ELECTR. 1000 GREEN	Cor: verde	1 850.00€



HV 1000V

Carro de ferramentas para eletricista com composição de ferramenta isolada a 1000volts

TABULEIROS

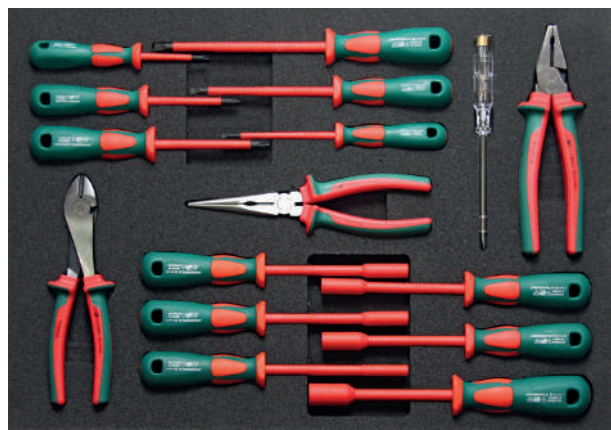

Composição: 43 peças

Tabuleiro com

- Jogo de alicate de pontas, universal e de corte
- Jogo chaves fenda e Philips
- Jogo chaves de caixa com punho
- Busca polos



Tabuleiro com

- Multímetro digital
- Jogo de extensões
- Roquete
- Navalha
- Jogo chaves de caixa 1/2" de 8 a 22mm
- Jogo chaves luneta de 8 a 14mm
- Jogo chaves bocas de 8 a 14mm
- Jogo chaves hexagonais de 4 a 8mm
- Chave ajustável

CARROS



C-6DWB1



C-7DC2B



HV1000V-V	Cor: verde	1 385.00€
HV1000V-C	Cor: cinza	1 385.00€

HV1000V-BLACK	Cor: preto	1 220.00€
HV1000V-GREEN	Cor: verde	1 220.00€

ELECTR

Carro de ferramentas para electricista, composição geral

TABULEIROS

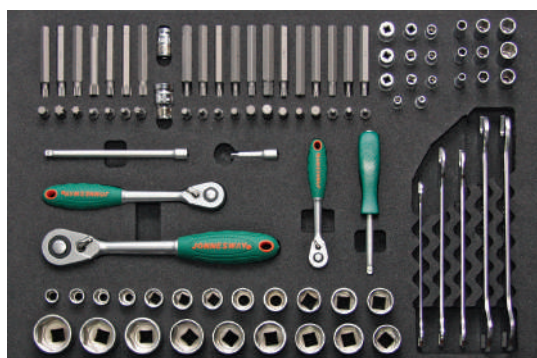
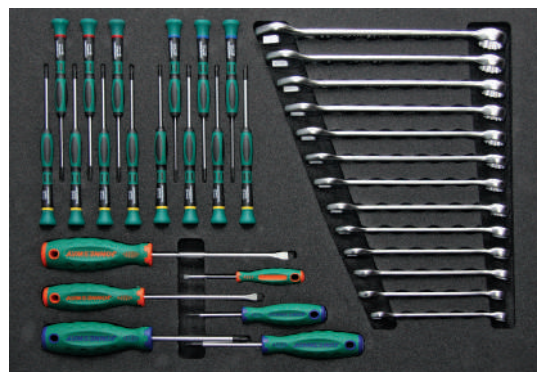

Composição: 144 peças

Tabuleiro com

Jogo alicates universal, de pontas, de corte
Mini alicates
Alicate de descarnar
Alicate de cravar terminais

Tabuleiro com

Jogo chaves mistas de 10 a 22mm,
Jogo chaves de precisão
Chaves fenda e Philips

Tabuleiro com

Jogo de bits com adaptadores
Jogo chaves de boca perfil fino de 10 a 19mm
Jogo chaves caixa 1/2" de 17 a 30mm
Jogo chaves de caixa 3/8" de 11 a 16mm
Jogo de roquetes e extensões

Tabuleiro com

Bandeja magnética
Gambiarras leds
Multímetro digital
X-acto
Tesoura
Raspador com lâminas





C-6DWB5



C-7DC2B



ELECTR-V	Cor: verde		1 500.00€
ELECTR-C	Cor: cinza		1 500.00€

ELECTR-BLACK	Cor: preto		1 325.00€
ELECTR-GREEN	Cor: verde		1 325.00€



CHAPEIRO 20

Carro de ferramentas para chapeiro

TABULEIROS



Composição: 55 peças
Tabuleiro com
 Lima de chapeiro
 Jogo de martelos chapeiro
 Chaves cavilhas

Tabuleiro com
 Jogo alicates universal, de pontas e de corte
 Desandador de percussão
 Jogo alicates de pressão

Tabuleiro com
 Jogo de ventosas
 Jogo chaves fenda e Philips de pancada
 Jogo de ferramentas para remoção de frisos plásticos

Tabuleiro com
 Jogo encontradores para ferro
 Kit remoção de vidros para brisas



C-4DWA1



C-7DC2B



CHAPEIRO20-V	Cor: verde		1 315.00€
CHAPEIRO20-C	Cor: cinza		1 315.00€

CHAPEIRO20- BLACK	Cor: preto		1 260.00€
CHAPEIRO20-GREEN	Cor: verde		1 260.00€



CHAPEIRO ALU

Carro de ferramentas para chapeiro

TABULEIROS

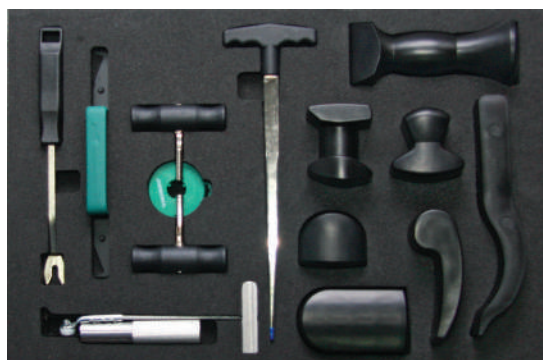

Composição: 56 peças

Tabuleiro com

Lima de chapeiro
Jogo de martelos chapeiro
Chaves cavilhas

Tabuleiro com

Jogo alicates universal, de pontas e de corte
Desandador de percussão
Jogo alicates de pressão

Tabuleiro com

Jogo de ventosas
Jogo chaves fenda e Philips de pancada
Jogo de ferramentas para remoção de frisos plásticos

Tabuleiro com

Jogo encontradores para alumínio
Kit remoção de vidros para brisas





C-4DWA1



C-7DC2B



CHAPEIROALU-V	Cor: verde		1 350.00€
CHAPEIROALU-C	Cor: cinza		1 350.00€

CHAPEIROALU-BLACK	Cor: preto		1 295.00€
CHAPEIROALU-GREEN	Cor: verde		1 295.00€



PINTOR20

TABULEIROS

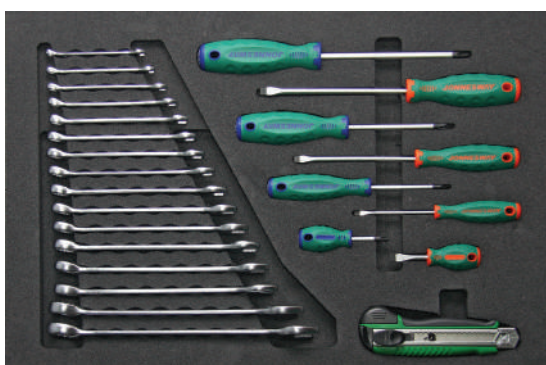

Composição: 55 peças

Tabuleiro com

Jogo de espátulas remoção de frisos
Espelho auxiliar de reparação de
mossas
Jogo chaves para remoção de
cavilhas e molas

Tabuleiro com

Pistola pintura
Base para lixa
Jogo de 4 espátula
Lixadora orbital
Saca terminais de cabo de baterias

Tabuleiro com

Jogo chaves luneta de 6 a 32mm,
X-acto
Jogo chaves fenda e Philips

Tabuleiro com

Jogo de 6 ventosas e acessórios



C-4DWA1



C-7DB2B

PINTOR20-V	Cor: verde		1 330.00€
PINTOR20-C	Cor: cinza		1 330.00€

PINTOR20-BLACK	Cor: preto		1 275.00€
PINTOR20-GREEN	Cor: verde		1 275.00€

MEC PESADOS

Carro de ferramentas com 7 gavetas
+ pega + bloco complementar

TABULEIROS

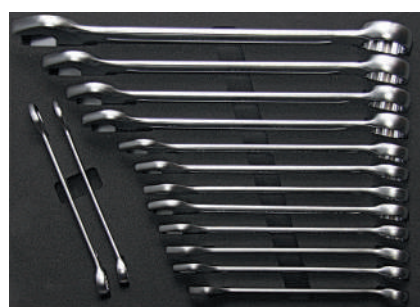
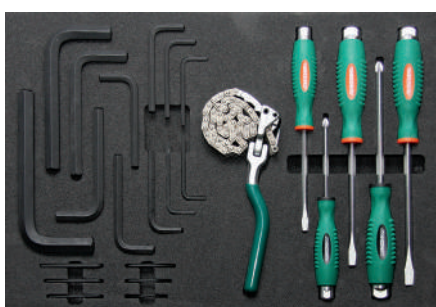
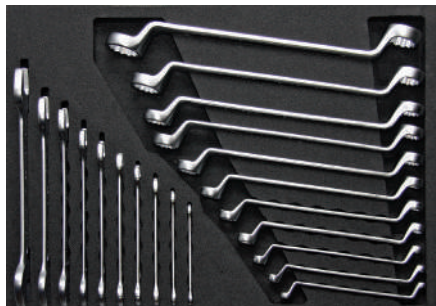

Composição: 162 peças
Tabuleiro com
Jogo chaves caixa de 1/2" de 8 a 34mm com roquete e extensão
Jogo chaves torx macho 1/2" de T30 a T80
Jogo chaves macho hexagonais de 1/2" de H5 a H19
Cardan
Rabo de força

Tabuleiro com
Jogo chaves caixa de impacto longas de 1/2" e 3/4" de 10 a 46mm
Adaptadores
Extensão
Cardan

Tabuleiro com
Jogo de martelos, marreta e alicates

MEC PESADOS 20A

2 790.00€



MEC PESADOS 20B

2 620.00€



C-SA2
3 700.00€
Armário modular

Dimensões totais: 2 322x1 980x526mm
 1 Módulo de armário vertical: 600x526x1980mm
 1 Módulo 6 gavetas: 861x500x994mm
 1 Módulo 2 portas: 861x500x994mm
 2 Armários superiores: 861x300x338mm
 2 Painéis perfurados: 861x20x338mm
 1 Tampo madeira: 1 725x480x40mm

C-SA2S
3 620.00€
Armário modular

Dimensões totais: 2 322x526x1 980mm
 1 Módulo de armário vertical: 600x526x1 980mm
 1 Módulo 6 gavetas: 861x500x994mm
 1 Módulo 2 portas: 861x500x994mm
 2 Armários superiores: 861x300x338mm
 2 Painéis perfurados: 861x20x338mm
 1 Tampo inox: 1 725x480x40mm

C-SA3
4 850.00€
Armário modular

Dimensões totais: 2 998x526x1 980mm
 1 Módulo de armário vertical: 600x526x1 980mm
 1 Módulo 6 gavetas: 861x500x994mm
 1 Módulo 6 gavetas: 676x500x994mm
 1 Módulo 2 portas: 861x500x994mm
 2 Armário superior: 861x300x338mm
 1 Armário superior: 676x300x338mm
 2 Painéis perfurados: 861x20x338mm
 1 Pannel perfurado: 676x20x338mm
 1 Tampo madeira: 2 404x480x40mm

C-SA3S
4 770.00€
Armário modular

Dimensões totais: 2 998x526x1 980mm
 1 Módulo de armário vertical: 600x526x1 980mm
 1 Módulo 6 gavetas: 861x500x994mm
 1 Módulo 6 gavetas: 676x500x994mm
 1 Módulo 2 portas: 861x500x994mm
 2 Armário superior: 861x300x338mm
 1 Armário superior: 676x300x338mm
 2 Painéis perfurados: 861x20x338mm
 1 Pannel perfurado: 676x20x338mm
 1 Tampo inox: 2 404x480x40mm

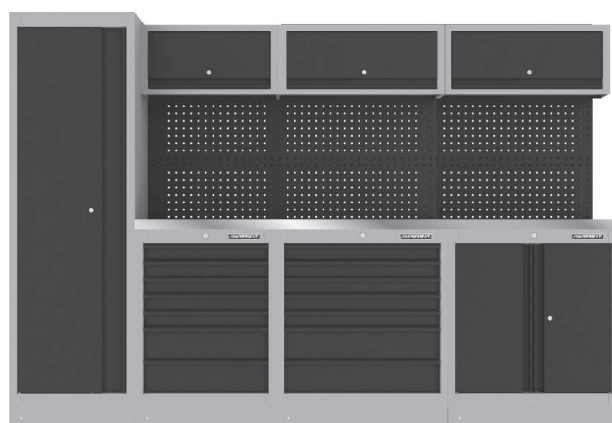

C-SA4S

4 550.00€

Armário modular

Dimensões totais: 2 998x526x1 980mm
 1 Módulo de armário vertical: 600x526x1 980mm
 1 Módulo 6 gavetas: 676x500x994mm
 1 Carrinho 7 gavetas: 671x459x940mm
 1 Módulo 2 portas: 861x500x994mm
 2 Armário superior: 861x300x338mm
 1 Armário superior: 676x300x338mm
 2 Painéis perfurados: 861x20x338mm
 1 Painel perfurado: 676x20x338mm
 1 Tampo aço inox: 2 404x480x40mm

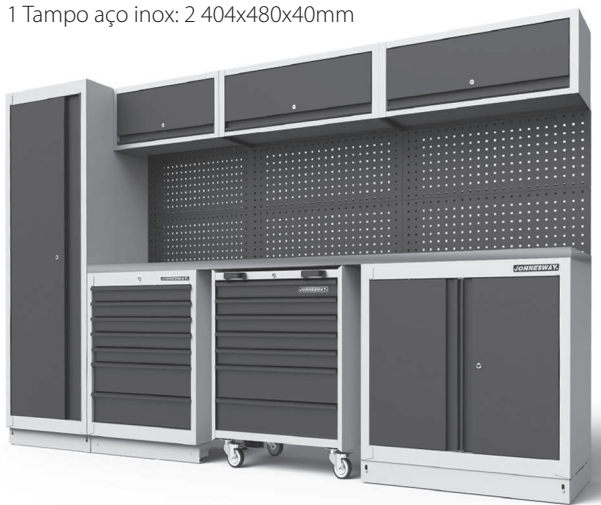

C-SQ2401

820.00€

Armário alto para arrumos

Dimensões totais: 600x526x1 980mm
 1 Porta



C-SP3401

230.00€

Armário de topo

Dimensões totais: 861x300x338mm
 Porta basculante



C-SQ3401

799.00€

Armário largo com 7 gavetas

Tampo não incluído.

Dimensões totais: 861x500x994mm
 7 Gavetas



C-SQ3402

525.00€

Armário largo com 2 portas

Tampo não incluído.

Dimensões totais: 861x500x994mm
 2 Portas



C-SQ3403

710.00€

Armário multifunções

Tampo não incluído.

Dimensões totais: 861x500x994mm
 1 Alojamento para rolo de papel
 1 Divisão para o lixo
 1 Divisão para arrumos



C-S7DW1

637.00€

Carro vazio para armário oficial

Permite ser arrumado em armário oficial

Dimensões totais: 671x459x940mm
 Peso: 52,4kg
 7 Gavetas



Armários e carros para ferramentas

C-SR3401
70.00€
Conjunto de 2 painéis perfurados

Dimensões totais: 861x20x338mm

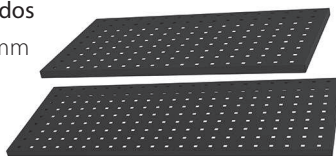
C-SU01
8.00€
Rodapé

Para armário alto.

Comprimento: 500mm

C-SU02
8.00€
Rodapé

É necessário incluir para os módulos de fecho.

Comprimento: 470mm

C-SW01
67.00€
Suporte lateral

É necessário incluir uma unidade para suporte do armário superior quando este ficar na extremidade.

C-SW02
43.00€
Suporte central para união de módulos

É necessário incluir uma unidade por cada 2 módulos.

C-SM
240.00€
Tampo de madeira para armário

Preço por metro

Dimensões totais: 1 000x480x40mm

C-SG
205.00€
Tampo em chapa galvanizada

Preço por metro

Dimensões totais: 1 000x480x40mm

C-SInox
525.00€
Tampo em aço inox liso

Preço por metro

Dimensões totais: 1 000x480x40mm

C-1DM1
285.00€
Gaveta lateral de apoio de laptop/ tablet até 14"

Adicional para carros de ferramentas

Dimensões gaveta: 410x285x70



* Exemplo de aplicação em carro de ferramentas

C-3DW5
630.00€
Carro vazio para ferramenta

Dimensões totais: 670x460x960mm

Peso: 54,2kg

3 Gavetas de 576x380x75mm

1 Arrumos com 2 portas de 603x404x478mm



C-4DWA1 Cor: verde  565.00€

C-4DWA1G Cor: cinza  565.00€

Carro vazio para ferramenta com 4 gavetas

Tampo especial preparado para banca de trabalho

Dimensões totais: 670x460x795mm

2 Gavetas de 579x380x56mm

1 Gaveta de 579x380x123mm

1 Gaveta de 579x380x179mm



C-7DC2B Cor: preto  465.00€

Carro vazio para ferramenta com 7 gavetas

Dimensões totais: 670x460x963mm

5 Gavetas de 576x380x75mm

2 Gavetas de 576x380x154mm

Peso total: 57kg

Capacidade de carga: 140kg/roda

Dimensão rodas: 127x25,5mm



C-6DWB1 Cor: verde  675.00€

C-6DWB1G Cor: cinza  675.00€

Carro vazio para ferramenta com 6 gavetas

Tampo especial preparado para banca de trabalho

Dimensões totais: 670x460x967mm

4 Gavetas de 579x380x56mm

1 Gaveta de 579x380x123mm

1 Gaveta de 579x380x179mm



C-6DWB5 685.00€

Carro vazio para ferramenta com 6 gavetas

Tampo revestido a plástico e suporte para ferramenta

Dimensões totais: 670x460x967mm

4 Gavetas de 579x380x56mm

1 Gaveta de 579x380x123mm

1 Gaveta de 579x380x179mm



C-7DS1 940.00€

Carro vazio para ferramenta com 7 gavetas

Tampo em aço

Dimensões totais: 710x500x967mm

1 Painel lateral perfurado

1 Painel lateral para compartimentos de arrumos

4 Rodas, 2 direcionais com travão

Peso total: 74,5kg

Capacidade de carga: 160kg/roda

* As caixas laterais são opção



C-7DW9 780.00€

Carro vazio para ferramenta com 7 gavetas

Sistema de segurança, abertura de 1 só gaveta

Dimensões totais: 670x460x967mm

5 Gavetas de 576x380x75mm

2 Gavetas de 576x380x154mm

Peso total: 74,5kg

Capacidade de carga: 75kg/roda

Dimensão rodas: 127x50,8mm



C-7 TOWER

1 050.00€

Carro vazio com 13 gavetas

Dimensões totais: 670x460x1 334mm

5 Gavetas de 576x380x75mm

2 Gavetas de 576x380x154mm

Caixa superior

3 Gavetas de 170x275x50mm

2 Gavetas de 569x275x50mm

1 Gaveta de 569x275x75mm

C-A16W

465.00€

Armário com 7 gavetas

Inclui 2 rodas para acoplamento aos carros C-7/ C-6

5 Gavetas de 288x380x75mm

2 Gavetas de 288x380x154mm

C-A17W

290.00€

Armário com 1 porta

Inclui 2 rodas para acoplamento aos carros C-7/ C-6

C-13DW53

1 900.00€

Carro grande vazio para ferramenta com 13 gavetas

Dimensões totais: 1 358x460x1 150mm

10 Gavetas de 576x380x75mm

2 Gavetas de 579x380x154mm

1 Gaveta de 1 216x380x173mm

C-10DW42

1 500.00€

Carro grande vazio para ferramenta com 10 gavetas

Dimensões totais: 1 070x460x981mm

1 Compartimento arrumação de 316x404x1 150mm

5 Gavetas de 288x380x75mm

2 Gavetas de 576x380x154mm

1 Gaveta de 288x380x154mm

1 Gaveta de 576x380x154mm

1 Gaveta de 928x380x173mm

C-T3

465.00€

Carro vazio para ferramenta com 3 gavetas

Tempo de abrir

Dimensões totais: 780x520x884mm



C-T12

205.00€

Carro com 3 prateleiras

Dimensões totais: 716x410x880mm

Peso: 20kg

Rodas: 4 (2 fixas+2 direcionais)



C-5CD

282.00€

Caixa metálica vazia para ferramenta com 5 malas

Dimensões totais: 431x307x381mm

5 Malas de 48x245x55mm



C-6DA4

280.00€

Caixa metálica vazia para ferramenta com 6 gavetas

Compartimento no topo com várias divisórias

Dimensões totais: 660x307x374mm

3 Gavetas de 172x270x41mm

2 Gavetas de 572x270x31mm

1 Gaveta de 572x270x65mm



C-6DA494

710.00€

Caixa de ferramenta com 6 gavetas - 98 peças

Compartimento no topo com várias divisórias

Dimensões totais: 660x307x374mm

Composição:

AG10002SC

D376514SC

R48115C

P08135C

S04H5129SC

V110115C

W251175C

W27AT025C



Malas vazias e complementos para carros

C-3DH5

145.00€

Caixa metálica vazia para ferramenta com 3 gavetas

Compartimento no topo

Dimensões totais: 535x220x290mm

3 Gavetas de 505x195x45mm



C-3DH2

72.00€

Caixa metálica vazia para ferramenta com 5 compartimentos

Dimensões totais: 470x240x220mm



C-3DH262

330.00€

Caixa metálica para ferramenta com 5 compartimentos - 62 peças

Dimensões totais: 470x220x350mm

Composição

P106 Alicates de corte

P116 Alicates de pontas

P087 Alicates universais

D70 Jogo de 6 chaves fenda/ phillips

W26 Jogo de 18 chaves mistas

R2904 Roquete de 1/2"

S04H41 Jogo de 18 chaves de caixa

S15H472 Adaptador

S24H4 Extensões

S22H41450 Cabo articulado 450mm

S23H41300 Cabo T correção 300mm

S21H4150 Extensão

S17H4121 Chave de velas 21mm

H03SM109S Jogo de chaves hexagonais



C-A456 70.00€

Tampo plástico para carros de ferramenta

Aplicável aos carros C-4/ C-6 e C-7



C-A9 55.00€

Base para torno e suporte para rolo de papel

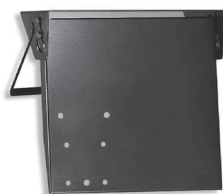

C-A27 50.00€

Tampo em acrílico resistente ao impacto para carros de ferramentas

Aplicável somente aos carros C-5DW/ C-6DW e C-7DW



C-7DW1-TS 95.00€

Tampo completo para carros de ferramentas

Aplicável somente aos carros C-5DW/ C-6DW e C-7DW

Composição

1 Tampo acrílico resistente ao impacto

1 Base metálica de apoio

1 Revestimento EVA de 2mm



C-A31 17.50€

Suporte lateral para chaves em T para fixação



C-A3 Cor: verde 17.00€

Pega para carro de ferramenta

Aplicável a C-4DW; C-6DW e C-7DW



C-A3-B Cor: preto 17.50€

Pega para carro de ferramenta

Aplicável a C-7DB2 e C-7DC2

C-A3G Cor: cinza 17.50€

Pega para carro de ferramenta

Aplicável a C-4DW; C-6DW e C-7DW

C-BS

Jogo de calhas direita e esquerda, para gavetas de carros e caixas

Ref.	Aplicação	Preço
C-BS Kit1	Carros: C-4DW/ C-5DW/ C-6DW/ C-7DW	17.00€
C-BS Kit2	Caixas: C-6DA4	10.50€
C-BS Kit3	Carros: C-10DW/ C-13DW	18.00€



C-PC

Canhão de fechadura

Ref.	Aplicação	Preço
C-PC1	C-6DA4	6.00€
C-PC2	C-5/ C-6/ C-7/ C-10/ C-13	6.70€
C-PC3	C-4	10.90€



C-PC4 9.40€

Canhão de fechadura para chaves tubulares

Inclui 2 chaves.



C-WHEEL
Rodas

Ref.	Tipo	Aplicação carro	Preço
C-WHEEL1	fixa	C-6/ C-7	17.00€
C-WHEEL2	travão	C-6/ C-7	21.00€
C-WHEEL5	fixa	C-4/ C-5/ C-7DB2	15.00€
C-WHEEL6	travão	C-4/ C-5/ C-7DB2	21.00€
C-WHEEL8	fixa	C-T3/ C-/12	11.50€
C-WHEEL9	travão	C-T3/ C-/12	13.30€

C-A
Torno de bancada

Ref.	Abertura (mm)	Peso (kg)	Preço
C-A7*	76	6	86.00€
C-A8*	101	7,25	102.00€
C-A10	127	10,2	132.00€
C-A11	152	14	160.00€
C-A12	203	18	204.00€
C-A13	254	24	285.00€



* Aplicável em carro de ferramenta (necessário suporte C-A9)

Malas vazias e complementos para carros
C-B
Torno de bancada com dupla rotação

Rotação 360° da base do torno

Rotação 360° da cabeça do torno

Ref.	Abertura (mm)	Peso (kg)	Preço
C-B5	127	17	180.00€

C-A2501S
20.00€
Conjunto de caixas plásticas para gavetas de carros de ferramenta

Composição

12 Caixas 93x93x43mm

4 Caixas 283x93x43mm

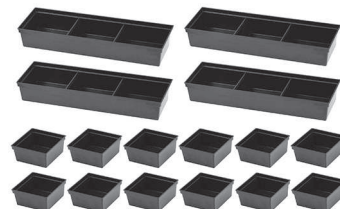
C-APB
21.50€
Conjunto de caixas plásticas para gavetas de carros de ferramenta

Composição

8 Caixas 283x93x43mm

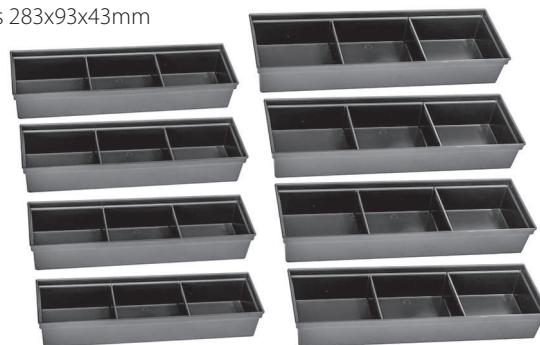



JONNESWAY®

de Profissionais para Profissionais

VDE Prüf- und Zertifizierungsinstitut

ZEICHENGENEHMIGUNG MARKS APPROVAL

Jonnesway Enterprise
Co. Ltd.
6F-9, No.51, Sec.2, Keelung Rd.
110 TAIPEI
TAIWAN

ist berechtigt, für ihr Produkt /
is authorized to use for their product

Kabelmesser
Cable knives

die hier abgebildeten markenrechtlich geschützten Zeichen
für die ab Blatt 2 aufgeführten Typen zu benutzen /
the legally protected Marks as shown below for the types referred to on page 2 ff.



Geprüft und zertifiziert nach /
Tested and certified according to

DIN EN 60900 (VDE 0682-201):2013-04; EN 60900:2012

Das Produkt entspricht den Anforderungen des deutschen Produktsicherheitsgesetzes (ProdSG)
hinsichtlich der Gewährleistung von Sicherheit und Gesundheit.
The product covers the requirements of the German Act "Produktsicherheitsgesetz (ProdSG)"
regarding the assurance of safety and health.



Befristet zum / valid until: 2020-02-29

Aktenzeichen: 5010169-3940-0010 / 223208

VDE Prüf- und Zertifizierungsinstitut GmbH
VDE Testing and Certification Institute
Zertifizierungsstelle / Certification

File ref.:
Ausweis-Nr. - 40035280 Blatt 1
Certificate No. Page

Weitere Bedingungen siehe Rückseite und Folgebblätter /
Further conditions see reverse and following pages
Offenbach, 2012-06-26
(letzte Änderung / updated 2016-05-25)

A: Fabian
VDE Zertifikate sind nur gültig bei Veröffentlichung unter:
VDE certificates are valid only when published on:

<http://www.vde.com/zertifkat>
<http://www.vde.com/certificate>

VDE



VDE Prüf- und Zertifizierungsinstitut

ZEICHENGENEHMIGUNG MARKS APPROVAL

Jonnesway Enterprise
Co. Ltd.
6F-9, No.51, Sec.2, Keelung Rd.
110 TAIPEI
TAIWAN

ist berechtigt, für ihr Produkt /
is authorized to use for their product
Zusammensetzbares Werkzeug
Assembly tool

die hier abgebildeten markenrechtlich geschützten Zeichen
für die ab Blatt 2 aufgeführten Typen zu benutzen /
the legally protected Marks as shown below for the types referred to on page 2 ff.



Geprüft und zertifiziert nach /
Tested and certified according to

DIN EN 60900 (VDE 0682-201):2013-04; EN 60900:2012

Das Produkt entspricht den Anforderungen des deutschen Produktsicherheitsgesetzes (ProdSG)
hinsichtlich der Gewährleistung von Sicherheit und Gesundheit.
The product covers the requirements of the German Act "Produktsicherheitsgesetz (ProdSG)"
regarding the assurance of safety and health.



Befristet zum / valid until: 2020-04-30

Aktenzeichen: 5010169-3940-0019 / 223207

VDE Prüf- und Zertifizierungsinstitut GmbH
VDE Testing and Certification Institute
Zertifizierungsstelle / Certification

File ref.:
Ausweis-Nr. - 40035263 Blatt 1
Certificate No. Page

Weitere Bedingungen siehe Rückseite und Folgebblätter /
Further conditions see reverse and following pages
Offenbach, 2012-06-26
(letzte Änderung / updated 2016-06-20)

VDE Zertifikate sind nur gültig bei Veröffentlichung unter:
VDE certificates are valid only when published on:

<http://www.vde.com/zertifkat>
<http://www.vde.com/certificate>

VDE





JONNESWAY®

Ferramenta Manual



**Tabuleiros para
composição
de carros**



Chaves



**Ferramenta
de aperto**



Martelos



Alicates



Diversos



AG010002SP

47.00€

Jogo de 4 alicates de freios

Composição:

AG010002 Alicates de freios interiores

AG010005 Alicates de freios interiores de ponta curva

AG010008 Alicates de freios exteriores

AG010011 Alicates de freios exteriores de pontas curvas 90°

A



AG010026SP

50.00€

Jogo de martelos e talhadeiras

Composição:

M09300 Martelo tipo alemão 300g

M11035 Martelo com batentes de borracha 400g

M61 Jogo de 3 talhadeiras

A



AG010150SC

97.00€

Jogo de 8 alicates de freios

Composição:

4 Alicates de pontas direitas

4 Alicates de pontas curvas

B

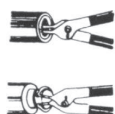

AG10001SP

105.00€

Jogo de machos e caçonetes

Composição:

17 Machos manuais: M3 a M12

17 Caçonetes: M3 a M12

1 Porta caçoneto

1 Desandador de machos

1 Punho desandador

B



AI10001SP

185.00€

Jogo de ferramentas para substituição de válvulas da cabeça do motor

Composição:

AN010064 Compressor de válvulas da cabeça do motor

AI020056 Alicates para vedantes de válvulas

AI020099 Adaptador de mola de válvula

AI020100 Suporte de válvulas

AI010012A Removedor de pastilhas de válvula

B



AI10002SP

149.00€

Jogo de ferramentas para substituição da polie da correia da cambota

Composição:

AE310030 Saca de 2 pernas

AE10035-1 Complemento para 3 pernas

AN010038 Saca vedante

AI020087A Saca polie da cambota

B



AI10003SP

119.00€

Jogo de chaves de copo para filtros

Composição:

- 9 Chaves de copo para filtros
- 14 Chaves para bujão do carter
- 1 Chave de filtros

B

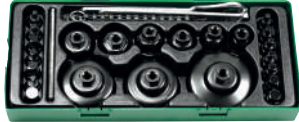

Description		
○ 8mm	BMW Ford	△ 10mm Renault
○ 9mm	General Motor	T-Bar To Drive
○ 10mm	Ford	30-160mm Oil Filter Chain 3/8" Oil
○ 12mm	Fiat, Lancia Peugeot	Filter Cap Wrench
○ 14mm	Mercedes, Lancia	93mm-15 GM, Nissan, Volvo, Mazda, Audi, VW, etc
○ 17mm	BMW, Austin, Audi, VW	76mm-14 VW, Porsche, Mercedes, BMW, Toyota
○ 3/8"	General Motor	75,6mm-14 Mazda, General Motor
□ 10mm	BMW, Renault, Toyota	38mm etc Diesel Engine
□ 8mm	Citroen, Peugeot, Renault, Talbot, Volvo	36mm Benz, VW, BMW/M52, M60, M73
□ 11mm	Ford	32mm GM, Saab, Saturn
□ 13mm	Nissan, Subaru	30mm General Motor
□ 3/8"	Honda, Mazda, Renault, Saab, Volvo	27mm Mercedes
□ 7mm	General Motor	24mm BMW/ 5 & 7 séries

AN10002SP

184.00€

Jogo de 42 peças de ferramenta para travões

Este tabuleiro ocupa meia gaveta do carro de ferramentas.

C

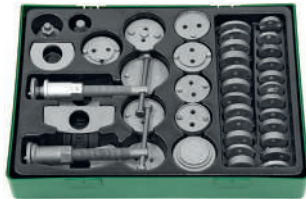

D70105SP

35.00€

Jogo de 5 chaves fenda/ phillips impacto

Composição/ medidas em mm:

- | | | | |
|-------------|--------------------|-------------|--------------------|
| D70S | 3 Chaves de fenda: | D70P | 2 Chaves phillips: |
| | 6,5x125 | | PH 2x100 |
| | 8x150 | | PH 3x150 |
| | 9,5x175 | | |

A



D71PP08SP

32.50€

Jogo de 8 chaves fenda/ phillips

Composição/ medidas em mm:

- | | | | |
|-------------|--------------------|-------------|--------------------|
| D71S | 4 Chaves de fenda: | D71P | 4 Chaves phillips: |
| | 6,5x38 | | 2x38 |
| | 4x80 | | 1x80 |
| | 5,5x125 | | 2x100 |
| | 6,5x150 | | 3x150 |

A



D725N08SP

69.00€

Jogo de 8 chaves de caixa de punho

Composição:

Chaves de 6 a 13mm

C



H10MB08SP

39.00€

Jogo de 8 chaves macho hexagonal com extremidade esférica e punho

Composição/ medidas em mm:

- | | | |
|--------------|---------|--------|
| H10MB | 2x100 | 5x150 |
| | 2,5x100 | 6X150 |
| | 3x100 | 8X200 |
| | 4x100 | 10X200 |

B



H10MT08SP

38.00€

Jogo de 8 chaves torx duplas tamperproof com punho

Composição/ medidas em mm:

- | | | |
|--------------|---------|---------|
| H10MT | T10x100 | T27x150 |
| | T15x100 | T30X150 |
| | T20x100 | T45X200 |
| | T25x100 | T50X200 |

B



H20MT08SP

40.80€

Jogo de 8 chaves torx duplas de punho

Composição/ medidas em mm:

- | | | |
|--|---------|---------|
| | T10x110 | T27x145 |
| | T15x120 | T30X155 |
| | T20x125 | T45X185 |
| | T25x135 | T50X205 |

B



M09513SP 73.00€

Jogo de martelos e punções

Composição:

- M07016 Martelo com batentes de plástico
- M09500 Martelo de mecânico tipo "alemão"
- M63M106S Jogo saca troços cromados
- M64M105S Jogo punções e escopros cromados

A



M645114SP 74.00€

Jogo de serra, chave inglesa, punções e escopros

Composição:

- M63 6 Punções
- M64 4 Escopros
- W27AS10 Chave inglesa
- MHS100AG Serra

B



MTC101SP 199.00€

Jogo de ferramenta de medição

Composição/ medidas em mm:

- Paquímetro digital 150
- Esquadro metálico 300
- Régua metálica 300
- Compasso 200
- Micrómetro 0-25
- Micrómetro 25-50
- Lapiseira

B



P018SP1 54.50€

Jogo de 3 alicates e 7 chaves hexagonais

Composição:

- P018 Alicate universal
- P038 Alicate de corte diagonal
- P068 Alicate de pontas
- H01SM109S Chaves hexagonais

A



P018SP 47.00€

Jogo de 3 alicates

Composição:

- P018 Alicate universal
- P038 Alicate de corte diagonal
- P068 Alicate de pontas

A



P04704SP 54.50€

Jogo de 4 alicates de corte

Não utilizar em metal.

A



P0803SP 43.00€

Jogo de 3 alicates isolados

Composição:

- P087 Alicate universal
- P097 Alicate de corte diagonal
- P118 Alicate de pontas

A



P0903SP 52.50€

Jogo de 3 alicates isolados

Composição:

- P0118 Alicate universal
- P0918 Alicate de corte diagonal
- P1118 Alicate de pontas

A



P2710SP 31.50€

Jogo de 2 alicates

Composição:

- P2710 Alicate ajustável
- P32M10A Alicate de pressão

A



P2803SP

50.00€

Jogo de 2 alicates e chave inglesa

Composição:

- W27AS10 Chave inglesa
- P2810 Alicates ajustável
- P32M10A Alicates de pressão

A



S03A4122SP

79.50€

Jogo de 22 chaves de impacto 1/2"

Composição/ medidas em mm:

- S03A4 Chaves: 10; 11; 12; 13; 14; 16; 17; 19; 21; 22 e 24
- S03AD4 Chaves: 10; 11; 12; 13; 14; 16; 17; 19; 21; 22 e 24

A



S04H2125SP

46.90€

Jogo de chaves de caixa com 24 peças de 1/4"

Composição/ medidas em mm:

- R3702 Roquete de 48 dentes
- S04H2 Chaves de caixa: 4; 5; 5,5; 6; 7; 8; 9; 10; 11; 12 e 13
- S04HD2 Chaves de caixa: 5; 6; 7; 8; 9; 10; 11; 12 e 13
- S24H250 Extensão 50
- S24H2150 Extensão 150
- S26H2150 Punho

A



S04H3157SP

121.00€

Jogo de 8 chaves de caixa com 56 peças de 1/4" e 3/8"

Composição/ medidas em mm:

- R3702 Roquete 1/4" de 48 dentes
- S04H2 Chaves 1/4": 4; 4,5; 5; 5,5; 6; 7; 8; 9; 10; 11; 12 e 13
- S04HD2 Chaves 1/4": 8; 10; 12 e 13
- S09H2 Bits hexagonais: 3; 4; 5 e 6
- S07H2 Bits torx: T10; T15; T20; T25; T27 e T30
- S10H2 Bits fendas: 4; 5,5 e 7
- S11H2 Bits phillips: PH1; PH2 e PH3
- S24H2 Extensões
- Adaptador de extensão
- S16H302 Adaptador universal
- Punho
- R3703 Roquete 3/8" de 48 dentes
- S04H3 Chaves 3/8": 14; 15; 17; 18; 19; 20; 22 e 24
- S04HD3 Chaves 3/8": 14; 15 e 17
- S17H3 Chaves de velas: 16 e 21
- S24H3 Extensões
- Adaptador extensão 3/8" - 1/2"
- S15H356 Adaptador universal

B



S04H3536SP

91.00€

Jogo de chaves de caixa e chaves mistas com 36 peças de 3/8"

Composição/ medidas em mm:

- R3503 Roquete de 72 dentes
- S04H3 Chaves de caixa: 6 a 22
- S24H3 Extensões
- Adaptador de extensão 1/2" - 3/8"
- S17H3 Chaves de velas: 16 e 21
- S15H356 Adaptador universal
- W26 Chaves mistas boca/ luneta: 7 a 17

B



S04H4125SP

85.00€

Jogo de chaves de caixa com 25 peças de 1/2"

Composição/ medidas em mm:

- R3704 Roquete de 48 dentes
- S04H4 Chaves: 10; 11; 12; 13; 14; 15; 16; 17; 18; 19; 20; 21; 22; 23; 24; 27; 30 e 32
- S24H4 Extensões
- S17H4 Chaves de velas: 16 e 21
- S23H4125 Cabo "T" corrediço
- S15H472 Adaptador universal

B



S04H4131SP

120.00€

Jogo de chaves e roquete com 31 peças de 1/2"

Composição/ medidas em mm:

- Roquete de 72 dentes
- Chaves de caixa: 10 a 32
- Chaves de velas: 16 e 21
- Cardan
- Extensão de 125
- Extensão de 250
- Cabo "T" correção de 250
- Bits hexagonais de 5; 6; 8; 10 e 12

C



S04H4524SP

98.00€

Jogo de chaves sextavadas com 24 peças de 1/2"

Composição/ medidas em mm:

- R3704 Roquete de 48 dentes
- S04H4 Chaves: 10; 11; 12; 13; 14; 15; 16; 17; 18; 19; 20; 21; 22; 23; 24; 27; 30 e 32
- S24H4 Extensões 5" e 10"
- S15H472 Adaptador universal
- S22H41375 Punho flexível 15"
- S23H41300 Cabo "T" correção

B



S04H4726SP

105.00€

Jogo de chaves de caixa com 26 peças de 1/2"

Composição/ medidas em mm:

- R3704 Roquete de 48 dentes
- S04H4 Chaves de caixa: 12; 13; 14; 15; 16; 17; 18; 19; 20; 21; 22; 23; 24; 25; 26; 27; 28; 30 e 34
- S24H4 Extensões 5" e 10"
- S17H4116 Chave de velas 16
- S15H472 Adaptador universal
- S23H41300 Cabo "T" correção
- S41H4 Manivela de punho metálico

B



S04H4728SP

95.00€

Jogo de chaves de caixa sextavadas com 28 peças de 1/2"

Composição/ medidas em mm:

- R3704 Roquete de 48 dentes
- S04H4 Chaves de caixa: 8; 9; 10; 11; 12; 13; 14; 15; 16; 17; 18; 19; 20; 21; 22; 23; 24; 25; 26; 27; 28; 30; 32 e 34
- S24H4250 Extensão 10"
- S15H472 Adaptador universal
- S23H41300 Cabo "T" correção

B



S06H427SP

79.00€

Jogo de chaves de caixa bits com 27 peças de 1/2" e 3/8"

Composição:

- S09H4 Bits hexagonais de 1/2"
- S49H4 Bits estriados de 1/2"
- S09H3 Bits hexagonais de 3/8"

A



S09H4118SP

58.50€

Jogo de chaves de caixa bits hexagonais com 18 peças de 1/2"

Composição:

- Chaves 55mm: H5; H6; H7; H8; H10; H12; H14; H17 e H19
- Chaves 100mm: H5; H6; H7; H8; H10; H12; H14; H17 e H19

A



S29H4140SP

41.50€

Jogo 40 bits de 3/8" para quadra de 1/2" e 3/8"

Composição:

- Bits hexagonais
- Bits torx
- Bits estriados
- Porta bits

A

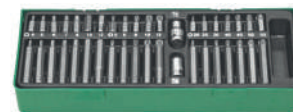

V1311SP 133.00€

Jogo de alicates de cravar e descarnar

Composição:

V1311 Alicates de cravar terminais isolados e não isolados

V1401 Alicates de descarnar fios

AG010031A Pesca magnético com espelho

Teste para circuitos

Kit com 60 terminais

B



W23108SP 52.50€

Jogo de 8 chaves de luneta 75°

Composição/ medidas em mm:

W23 Chaves: 6x7; 8x9; 10x11; 12x13; 14x15; 16x17; 18x19 e 20x22

A



W24A109SP 130.00€

Jogo de 9 chaves de luneta aberta flexível

Composição/ medidas em mm:

W24A Chaves: 8x8; 10x10; 11x11; 12x12; 13x13; 14x14; 17x17; 19x19 e 22x22

A



W25110SP 51.50€

Jogo de 10 chaves de bocas

Composição/ medidas em mm:

W25 Chaves: 6x7; 8x9; 10x11; 12x13; 14x15; 16x17; 18x19; 21x23; 24x27 e 30x32

A



W26112SP 49.00€

Jogo de 12 chaves mistas de boca/ luneta

Composição/ medidas em mm:

W26 Chaves: 8; 9; 10; 11; 12; 13; 14; 15; 16; 17; 19 e 22

A



W26116SP 64.00€

Jogo de 16 chaves mistas de boca/ luneta

Composição/ medidas em mm:

W26 Chaves: 6; 7; 8; 9; 10; 11; 12; 13; 14; 15; 16; 17; 18; 19; 22 e 24

B



W45112SP 136.00€

Jogo de 12 chaves mistas de boca/ roquete de 72 dentes

Composição/ medidas em mm:

W45 Chaves: 8 a 19

A



W47108SP 71.50€

Jogo de 8 chaves de luneta angular com roquete

Composição/ medidas em mm:

W47 Chaves: 6x7; 8x9; 10x11; 12x13; 14x15; 16x18; 17x19 e 21x22

A



W60115SP 155.00€

Jogo de 15 chaves de boca/ roquete reversível de 72 dentes

Composição/ medidas em mm:

W60 Chaves: 9 a 19
Adaptadores de 1/4"; 3/8" e 1/2"
Porta bits de 10

B



W70A118S 210.00€

Jogo de chaves em "T" com roquete articulado

Composição/ medidas em mm:

W60 Chave em "T" de 300
Chave em "T" de 50
Chave com roquete de 72 dentes
Extensão de 3"
Extensão de 6"
Adaptador 3/8" (F)x3/8" (F)

B



Tabuleiros de ferramenta para carros

Tabuleiros em espuma de alta densidade EVA

JA-C131SV

550.00€

Gaveta para serviço em pneus (gaveta completa)

Composição:

- JAI-0924 Pistola pneumática de 1/2"
- JAR-6309A Roquete pneumático de 1/2"
- JAG-0906R Retificadora pneumática de 1/4"
- Chaves de impacto longas de 1/2"
- Chaves de impacto de 1/2"
- Adaptador de 3/8"-1/2"
- Adaptador de 1/2"-3/8"
- Adaptador de 1/2"-3/4"
- Cardan de 1/2"
- Extensões de 1/2"

D



D71157SV

190.00€

Gaveta com chaves de fenda/ phillips, alicates e bits (gaveta completa)

Composição/ medida em mm:

- Chaves de fenda: 6,5x38; 4x80; 5,5x125 e 6,5x150
- Chaves phillips: PH2x38; PH1x80; PH2x100 e PH3x150
- Chaves de fenda/pancada: 6,5x125; 8x150 e 9,5x175
- Chaves phillips/pancada: PH2x100 e PH3x150
- Bits hexagonais: 4; 5; 6; 7; 8; 10 e 12 de 30 e 75mm de comprimento
- Bits torx: T20; T25; T30; T40; T45; T50 e T55 de 30 e 75mm de comprimento
- Bits XZN: M5; M6; M8; M10 e M12 de 30 e 75mm de comprimento
- Porta bits de 3/8" e 1/2"
- Alicates de freios

D

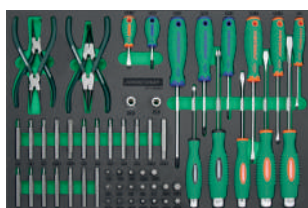

D737128SV

180.00€

Gaveta com chaves de fenda/ phillips (gaveta completa)

Composição:

- D71PP08SP Jogo de chaves de fenda/ phillips
- D70105SP Jogo de chaves de fenda/ phillips pancada
- M645114SP Jogo de serra, chave inglesa, punções e escopros

D



D737134SV

180.00€

Gaveta com chaves de fendas/ phillips (gaveta completa)

Composição:

- D3750P065S Jogo de chaves de precisão
- D3750T08S Jogo de chaves de precisão
- D70105SP Jogo de chaves de fenda/ phillips pancada
- D71PP08SP Jogo de chaves de fenda/ phillips
- W43A106S Jogo de chaves de caixa flexível

D



H10121SV

139.00€

Gaveta com chaves macho hexagonais de punho, talhadeiras e martelos (gaveta completa)

Composição:

- H10MB08S Jogo de chaves duplas hexagonais de punho
- H10MT08S Jogo de chaves duplas torx tamperproof de punho
- AG010026S Jogo de martelos e talhadeiras

D

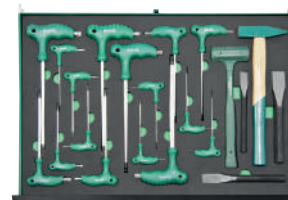

P82714SV

220.00€

Gaveta com alicates (gaveta completa)

Composição:

- P018SP Jogo de alicates
- P2710SP Jogo de alicates
- AG010002SP Jogo de alicates de freios
- P71 Jogo de mini alicates

D



P82736SV

237.00€

Gaveta com alicates e bits de caixa (gaveta completa)

Composição:

- S06H427SP Jogo de chaves de caixa bits de 1/2" e 3/8"
- AG010002SP Jogo de alicates de freios
- P018SP Jogo de alicates
- P2710SP Jogo de alicates

D



S04H2184SV

177.00€

Gaveta com 74 peças de 1/4" (gaveta completa)

Composição:

Roquete de 1/4"
 Chaves de caixa de 1/4": 4 a 14mm
 Bits de caixa hexagonais de 1/4": H2 a H6
 Adaptador 3/8"(F) x 1/4" (M)
 Adaptador 1/4" (M) x 3/8" (F) para cabo "T" corrediço
 Cardan de 1/4"
 Extensões de 1/4": 100mm e 150mm
 Manivela 1/4": 150mm
 Cabo "T" corrediço de 1/4": 130mm
 Punho de 1/4" com função fixa/cardan 280mm
 Extensão flexível de 1/4": 145mm
 Bits phillips, fenda, pozidrive, hexagonais, torx
 Chaves de precisão fenda/ phillips
 Chaves de fenda/ impacto 9,5x200mm e 9,5x300mm
 Chave de fenda 5x150mm
 Chave de fenda isolada 1000V 5,5x125mm

D

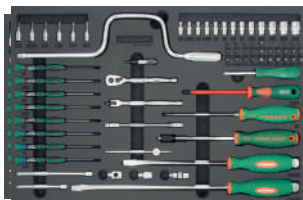

S04H3194SV

215.00€

Gaveta com 94 peças de 1/4" e 3/8" (gaveta completa)

Composição:

Roquete de 1/4"
 Chaves de caixa de 1/4": 5 a 14mm
 Bits de caixa fenda de 1/4": 3,5; 5,5 e 7mm
 Bits de caixa hexagonais de 1/4": H3, H4, H5, H6 e H7
 Bits de caixa phillips de 1/4": PH1; PH2 e PH3
 Bits de caixa torx interior de 1/4": E4; E5; E6; E7 e E8
 Bits de caixa torx de 1/4": T10; T15; T20; T25; T30; T35 e T40
 Punho de 1/4" com função fixa/ cardan 280mm
 Bits torx tamperproof com encaixe de 1/4": T7 a T40
 Bits phillips com encaixe de 1/4": PH1; PH2 e PH3
 Cabo "T" corrediço de 1/4": 115mm
 Extensão de 1/4": 150mm
 Cardan de 1/4"
 Bits e porta bits de 1/4"
 Bit torx tamperproof de 3/8": T55
 Roquete de 1/4" de 36 dentes
 Adaptador 3/8" x 1/4"
 Chaves caixa 3/8": 7 a 22mm
 Chaves torx interior 3/8": E10; E12 e E14
 Chave torx 3/8": T40
 Bits caixa XZN 3/8": M6; M8 e M10
 Extensões 3/8": 75mm e 150mm
 Roquete e roquete flexível de 3/8" com 36 dentes
 Cardan de 3/8"
 Adaptador 1/4" (F) x 3/8" (M)

D



Tabuleiros de ferramenta para carros

Tabuleiros em espuma de alta densidade EVA

S04H42165SV

230.00€

Gaveta com 65 peças de 1/4" e 1/2" (gaveta completa)

Composição:

Roquete de 1/4" de 48 dentes
 Chaves de caixa 1/4": 4 a 13mm
 Chaves de caixa longas de 1/4": 5 a 13mm
 Extensões de 1/4": 50mm e 150mm
 Punho de 1/4"
 Roquete de 1/2" com 48 dentes
 Chaves de caixa 1/2": 10 a 32mm
 Chaves de velas 1/2": 16 e 21mm
 Extensões de 1/2": 125mm e 250mm
 Cabo "T" corrediço
 Cardan de 1/2"
 Chaves mistas de 6 a 24mm

D



S04H4295SV

230.00€

Gaveta com chaves de caixa e roquete (gaveta completa)

Composição:

S04H2125SP Jogo de chaves de caixa com 25 peças de 1/4"
 S04H4131SP Jogo de chaves de caixa com 31 peças de 1/2"
 S29H4140SP Jogo de 40 bits de 1/2" e 3/8"

D



S04H46121SV

308.00€

Gaveta com chaves de caixa e roquete (gaveta completa)

Composição:

S04H3157SP Jogo de chaves de caixa com roquete de 1/4" e 3/8"
 S04H4125SP Jogo de chaves de caixa com roquete de 1/2"
 S29H4140SP Jogo de 40 bits de 1/2" e 3/8"

D



Tabuleiros de ferramenta para carros

Tabuleiros em espuma de alta densidade EVA



W23559SV

205.00€

Gaveta com chaves de fenda/ phillips/ luneta e alicates (gaveta completa)

Composição:

D71PP08SP Jogo de chaves fenda e phillips

W23108SP Jogo de chaves luneta 75°

P0903SP Jogo de alicates

S29H4140SP Jogo de bits de 1/2" e 3/8"

D

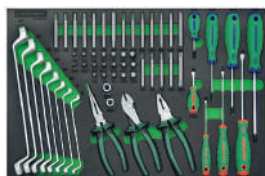

W26134SV

210.00€

Gaveta com chaves de luneta/ mistas/ alicates (gaveta completa)

Composição:

W23108SP Jogo de chaves luneta 75°

P0903SP Jogo de alicates

W26112SP Jogo de chaves mistas (boca/ luneta)

H01SM109S Jogo de chaves hexagonais

P28210 Alicata ajustável

P32M10A Alicata de pressão

D



W2623431SV

195.00€

Gaveta com chaves de luneta e mistas (gaveta completa)

Composição:

W23108SP Jogo de chaves luneta 75°

W24106S Jogo de chaves luneta aberta

W26116SP Jogo de chaves mistas boca / luneta

AI050077 Cinta para filtros óleo

D



W26315SV

315.00€

Tabuleiro com 15 chaves mistas (gaveta completa)

Composição:

W26 20; 21; 23; 25; 26; 27; 28; 29; 30; 32; 36; 38; 41; 46 e 50mm

D



D70105KV

41.00€

Tabuleiro com 5 chaves pancada fenda/ phillips (1/3 de gaveta)

Composição:

D70S6125 Chave fenda 6,5x125mm

D70S8150 Chave fenda 8x150mm

D70S9175 Chave fenda 9,5x175mm

D70P2100 Chave phillips PH2x100mm

D70P3150 Chave phillips PH3x150mm

A



D70PS119KV

71.00€

Tabuleiro com 5 chaves fenda/ phillips e desandador (1/3 de gaveta)

Composição:

3 Chaves phillips pancada: PH1x75; PH2x100 e PH3x125

2 Chaves fenda pancada: 6,5x150 e 9,5x200

1 Desandador de percussão com 13 bits

A



D71PP08KV

44.00€

Tabuleiro com 8 chaves fenda/ phillips (1/3 de gaveta)

Composição:

D71S Jogo de 4 chaves fenda
6,5x38; 4x80; 5,5x125 e 6,5x150mm

D71P Jogo de 4 chaves phillips
PH1X80; PH2X38; PH2x100 e PH3x150mm

A



H10MB08KV

44.50€

Tabuleiro com 8 chaves hexagonais de punho (1/3 de gaveta)

Composição:

H10MB Jogo de 8 chaves macho
2x100; 2,5x100; 3x100; 4x100; 5x150; 6x150, 8x200
e 10x200mm

A

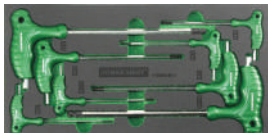

H10MT08KV

44.50€

Tabuleiro com 8 chaves torx tamperproof de punho (1/3 de gaveta)

Composição:

H10MT Jogo de 8 chaves torx
T10x100; T15x100; T20x100; T25x100; T27x150;
T30x150; T45x200 e T50x200mm

A



M09103KV

58.00€

Tabuleiro com martelos e chave inglesa (1/3 de gaveta)

Composição:

M09300 Martelo tipo alemão
M11035 Martelo borracha (anti recuo)
W27AS10 Chave inglesa

A



M63113KV

60.00€

Tabuleiro com saca troços, talhadeiras, punções e buril (1/3 de gaveta)

Composição:

6 Saca troços
4 Talhadeiras
1 Buril
1 Punção de bico
1 Punção

A



Tabuleiros de ferramenta para carros

Tabuleiros em espuma de alta densidade EVA

MHS08KV

63.00€

Tabuleiro com serra e vários (2/3 de gaveta)

Composição:

1 Serra com 2 lâminas extra
1 Fita métrica 3m
1 Régua 330mm
1 X-ato

B



P011804KV

71.00€

Tabuleiro com 4 alicates (1/3 de gaveta)

Composição:

P0817 1 Alicate universal
P1017 1 Alicate de corte diagonal
P1118 1 Alicate de pontas
P2710 1 Alicate ajustável

A



P32M105KV

68.00€

Tabuleiro com 5 alicates (1/3 de gaveta)

Composição:

AG010002 1 Alicate de freios interiores direito
AG010005 1 Alicate de freios interiores curvo
AG010008 1 Alicate de freios exteriores direito
AG010011 1 Alicate de freios exteriores curvo
P32M10A 1 Alicate de pressão

A

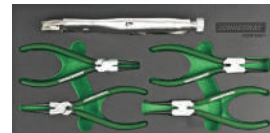

S03A4122KV

97.00€

Tabuleiro com 22 chaves de impacto 1/2" (1/3 de gaveta)

Composição:

S03A Jogo chaves impacto
10; 11; 12; 13; 14; 16; 17; 19; 21; 22 e 24
S03AD Jogo chaves impacto longa
10; 11; 12; 13; 14; 16; 17; 19; 21; 22 e 24

A



Tabuleiros de ferramenta para carros

Tabuleiros em espuma de alta densidade EVA

S04H2132KV

124.00€

Tabuleiro com 32 peças, chaves de bits e extensões (1/3 de gaveta)

Composição:

- S09H3 Chaves caixa bit hexagonais 1/2"
- S09H4 Chaves caixa bit hexagonais 3/8"
- S49H4 Chaves caixa bit estriado 1/2"
- S24H4 Extensões 1/2" - 125 e 250mm
- S17H4 Chaves velas - 16 e 21mm
- S23H4125 Cabo em "t" corrediço

A



S04H4144KV

125.00€

Tabuleiro com 44 peças, chaves caixa com roquete (1/3 de gaveta)

Composição:

- R3704 Roquete 1/2"
- R3702 Roquete 1/4"
- S04H4 Chaves caixa 1/2"
10; 11; 12; 13; 14; 15; 16; 17; 18; 19; 20; 21; 22; 23; 24;
27; 30 e 32mm
- S04H2 Chaves caixa 1/4"
4; 5; 5,5; 6; 7; 8; 9; 10; 11; 12 e 13mm
- S04HD2 Chaves caixa longa 1/4"
5; 6; 7; 8; 9; 10; 11; 12 e 13mm
- S24H2 Extensões 1/4" - 50 e 150mm
- S26H2150 Punho 1/4"
- S15H472 Cardan 1/4"

A



S06H427KV

95.00€

Tabuleiro com 27 bits de caixa (1/3 de gaveta)

Composição:

- S09H3 6x Bits hexagonais de 3/8"
- S09H4 11x Bits hexagonais de 1/2"
- S49H4 10x Bits estriados de 3/8"

A

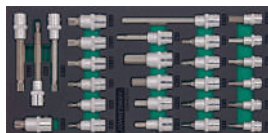

S07H2138KV

78.00€

Tabuleiro com 18 peças, jogo de bits (1/3 de gaveta)

Composição:

- S06H2 7 Chaves de caixa torx int. 1/4": E4; E5; E6; E7; E8; E10 e E11
- S07H2 11 Bits caixa Torx de 1/4": T6; T7; T8; T9; T10; T15; T20 e T25
- S09H2 5 Bits caixa hexagonais de 1/4": 3, 4, 5 e 6mm
- S10H2 4 Bits caixa fenda 1/4": 3; 4,5; 5,5 e 7mm
- S11H2 4 Bits caixa phillips 1/4": PH0, PH1; PH2 e PH3
- S12H2 4 Bits caixa pozi 1/4": PZ0, PZ1, PZ3 e PZ3
- AG010184C 1 Punho flexível 1/4" com caixa 7mm
- AG0100184D 1 Punho flexível 1/4" com caixa 8mm
- 1 Punho flexível de 1/4" com caixa

A



S29H4141KV

68.50€

Tabuleiro com 41 peças, jogo de bits (1/3 de gaveta)

Composição:

- Bits hexagonais
- Bits torx
- Bits estriados
- Porta bits 1/2"
- Porta bits 3/8"
- Chave para molas de travão

A



W25106KV

33.00€

Tabuleiro com 6 chaves de bocas (1/3 de gaveta)

Composição:

- W25 6x7; 8x9; 10x11; 12x13; 14x15 e 16x17

A



W25107KV

80.00€

Tabuleiro com 7 chaves de bocas (2/3 de gaveta)

Composição:

- W25 18-19; 20-22; 21-23; 24-16; 25-28; 27-30 e 30-32mm

B



Tabuleiros de ferramenta para carros

Tabuleiros em espuma de alta densidade EVA

W25110KV

60.00€

Tabuleiro com 10 chaves de bocas (1/3 de gaveta)

Composição:

W25 6x7; 8x9; 10x11; 12x13; 14x15; 16x17; 18x19; 21x23; 24x27 e 30x32

A

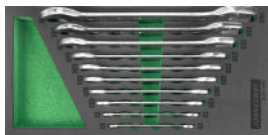

W26108KV

85.00€

Tabuleiro com 8 chaves mistas (2/3 de gaveta)

Composição:

W26 18; 19; 21; 22; 24; 27; 30 e 32mm

B



W26110KV

45.00€

Tabuleiro com 10 chaves mistas (1/3 de gaveta)

Composição:

W26 6; 7; 8; 10; 11; 12; 13; 14; 16 e 17mm

A



W26116KV

69.00€

Tabuleiro com 16 chaves mistas - boca/ luneta (1/3 de gaveta)

Composição:

W26 6; 7; 8; 9; 10; 11; 12; 13; 14; 15; 16; 17; 18; 19; 20 e 22mm

A



W65105KV

38.50€

Tabuleiro com 5 chaves curva luneta (1/3 de gaveta)

Composição:

8x10; 10x12; 13x15; 14x17 e 19x22mm

A

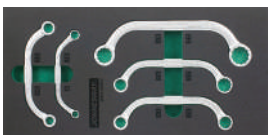

Tabuleiros de ferramenta para caixa C-6DA4

AG10002SC

53.00€

Jogo de machos e caçonetes

Composição:

Machos M3 a M12
Caçonetes M3 a M12
Porta caçonetes
Desandador de machos



D376514SC

40.50€

Jogo de chaves

Composição:

Jogo de chaves de precisão
Phillips: PH00; PH0 e PH1
Fenda: 2; 2,4 e 3mm
Torx: T5; T6; T7; T8; T9; T10; T15 e T20



P0813SC

44.00€

Jogo de alicates

Composição:

P087 Alicate universal
P097 Alicate de corte
P118 Alicate de pontas



R4811SC

63.00€

Jogo de chaves de caixa de 1/4" e 3/8"

Composição/ medidas em mm:

Roquete de 1/4" de 72 dentes
Roquete de 3/8" de 72 dentes
Extensão de 3/8": 75
Extensão de 3/8": 250
Extensão de 1/4": 50
Extensão de 1/4": 150
Cardan de 1/4"
Cardan de 3/8"
Adaptador 1/4" - 3/8"
Adaptador 3/8" - 1/2"
Punho



Tabuleiros de ferramenta para caixa C-6DA4
S04H5129SC
52.00€
Jogo de chaves de caixa sextavadas de 1/4 e 3/8" com 28 peças

Composição/ medidas em mm:

Chaves de caixa de 1/4": 4; 4,4; 5; 5,5; 6; 7; 8; 9; 10; 11; 12 e 13

Chaves de caixa longa: 8; 10; 12 e 13

Chaves de caixa 3/8": 14; 15; 17; 18; 19; 20; 22 e 24

Chaves de caixa longa: 14; 15 e 17

Chaves de velas 3/8": 16 e 21

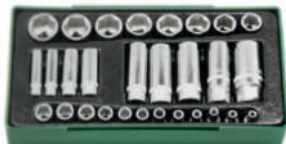
V11011SC
41.50€
Jogo com alicate de cravar fêmeas

Composição/ medidas em mm:

Alicate de cravar

Bicos M3 a M6

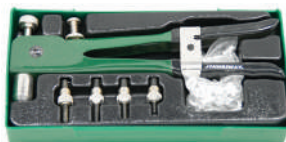
W25117SC
59.00€
Jogo de chaves bocas e hexagonais

Composição/ medidas em mm:

Chaves de bocas: 8x9; 10x11; 12x13; 14x15; 16x17; 18x19; 20x22 e 24x27

Chaves hexagonais: 1,2; 2; 2,5; 3; 4; 5; 6; 8 e 10

W27AT02SC
50.00€
Jogo de alicates

Composição/ medidas em mm:

P32M10C Alicate de pressão

W27AT10 Chave ajustável

Tabuleiros em espuma EVA aplicáveis aos carros: C-4DW, C-6DW e C-7D

P-EVA(D70105KV) 10.00€

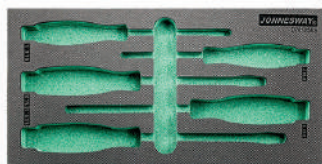

P-EVA(D71PP08KV) 10.00€

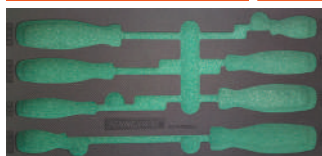

P-EVA(D737128SV) 29.60€



P-EVA(D737134SV) 29.60€

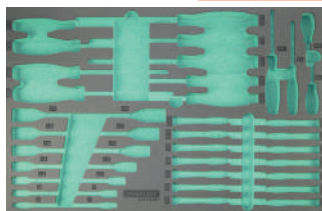

P-EVA(H10MB08KV) 10.00€



P-EVA(H10MT08KV) 10.00€

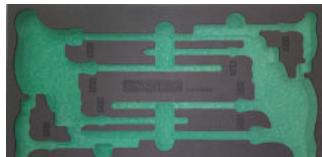

P-EVA(H10121SV) 29.60€



P-EVA(P82736SV) 29.60€



P-EVA(M09103KV) 10.00€



P-EVA(M63113KV) 10.00€



P-EVA(MHS08KV) 19.00€



P-EVA(P011804KV) 10.00€



P-EVA(P32M105KV) 10.00€



P-EVA(P82714SV) 29.60€



Tabuleiros de ferramenta vazios

Tabuleiros em espuma EVA aplicáveis aos carros: C-4DW, C-6DW e C-7D

P-EVA(S03A4122KV)

10.00€

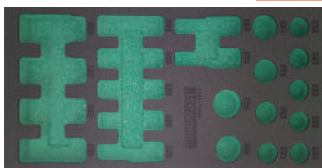

P-EVA(S04H2132KV)

10.00€



P-EVA(S04H4144KV)

10.00€



P-EVA(S04H4295SV)

29.60€

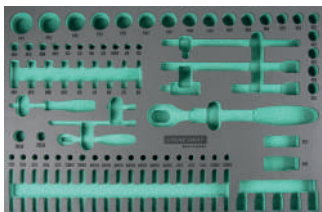

P-EVA(S04H42165SV)

29.60€

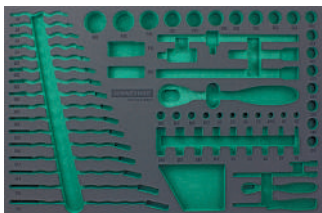

P-EVA(S04H45121SV)

29.60€

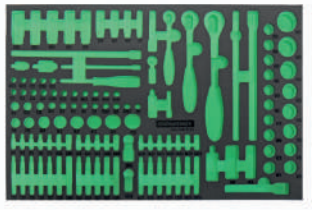

P-EVA(S29H4141KV)

10.00€

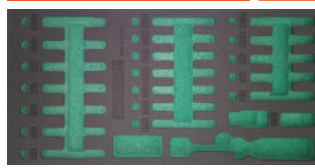

P-EVA(W23559SV)

29.60€

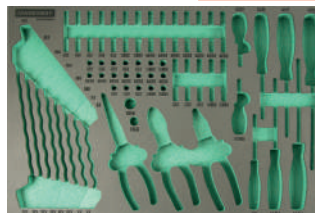

P-EVA(W25110KV)

10.00€

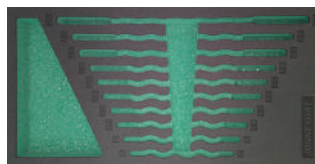

P-EVA(W26116KV)

10.00€

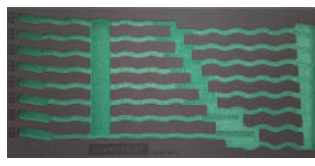

P-EVA(W26134SV)

29.60€



P-EVA(W2623431SV)

29.60€



Tabuleiros de ferramenta

Caixas plásticas para tabuleiros

P-B (31)

5.50€

Medidas:

425x185x52mm

B



P-B (41)

4.50€

Medidas:

375x144,5x52mm

A



Tabuleiros de ferramenta vazios para composições

aplicáveis aos carros: C-4DW, C-6DW e C-7DW

P-TR(AG010002SP)	2.20€
P-TR(AG010026SP)	2.20€
P-TR(AI10002SP)	2.50€
P-TR(D70105SP)	2.20€
P-TR(D71PP08SP)	2.20€
P-TR(H10MB08SP)	2.50€
P-TR(M09513SP)	2.20€
P-TR(M645114SP)	2.50€
P-TR(P04704SP)	2.20€
P-TR(P0803SP)	2.20€
P-TR(P0903SP)	2.20€
P-TR(S03A4122SP)	2.20€
P-TR(S04H2125SP)	2.20€
P-TR(S04H3157SP)	2.70€
P-TR(S04H3536SP)	2.70€
P-TR(S04H4125SP)	2.70€
P-TR(S04H4524SP)	2.20€
P-TR(S04H4726SP)	2.80€
P-TR(S04H4728SP)	2.80€
P-TR(S06H427SP)	2.20€
P-TR(S09H4118SP)	2.20€
P-TR(S29H4140SP)	2.70€
P-TR(W23108SP)	2.20€
P-TR(W25110SP)	2.20€
P-TR(W26112SP)	2.20€
P-TR(W26116SP)	2.50€



Tabuleiros de ferramenta vazios para composições

aplicáveis à mala: C-3DH2

P-TR (D70SP06ST)

1.50€

Para chaves D70



P-TR (PC303ST)

1.50€

Para alicates: P087; P106 e P118



P-TR (S04H4120ST)

1.70€

Para chaves de caixa de 1/2" com roquete



P-TR (S04H4506ST)

1.70€

Para extensões



P-TR (W26107ST)

1.70€

Para chaves mistas W26



P-TR (W26920ST)

1.50€

Para chaves mistas W26 e chaves hexagonais



Ferramenta de aperto

T21

Chave dinamométrica com precisão de: +/- 3%

Ref.	Quadra	Torque (Nm)	Comp. (mm)	Preço
T21025N	1/4"	5-25	320	99.90€
T21050N	3/8"	10-50	390	104.00€
T211000N	1"	200-1 000	1 510	535.00€
T21101N	1/2"	20-100	390	112.00€
T21200N	1/2"	40-200	502	112.00€
T21340N	1/2"	60-340	604	137.00€
T21341N	3/4"	60-340	604	147.00€
T21550N	3/4"	110-550	938	340.00€



T25

Chave dinamométrica com precisão de: +/- 4%

Ref.	Quadra	Torque (Nm)	Comp. (mm)	Preço
T25100N	3/8"	20-100	390	85.50€
T25200N	1/2"	40-200	502	92.00€
T25340N	1/2"	60-340	604	112.00€



T27

Chave dinamométrica com precisão de: +/- 4%

Ref.	Quadra	Torque (Nm)	Comp. (mm)	Preço
T27010N	1/4"	2-10	308	60.50€
T27020N	1/4"	4-20	340	59.50€
T27021N	3/8"	4-20	340	60.00€
T27060N	3/8"	10-60	340	66.50€
T271001N	1"	200-1 000	1 177	445.00€
T27101N	1/2"	20-100	458	73.00€
T27200N	1/2"	40-200	531	78.50€
T27340N	1/2"	60-340	585	86.50€
T27800N	3/4"	150-800	1 177	373.00€



T30200NS

233.00€

Barra dinamométrica com conjunto de 9 ponteiros de bocas - Precisão 4%

Composição:

Torque: 40-200 Nm
Cabeçote 1/2"
Encaixe: 14x18mm
Ponteiros: 13; 14; 15; 17; 19; 22; 24; 27 e 30mm



T33

Chave dinamométrica reversível

Precisão: sentido horário: 5%
sentido anti-horário: 6%

Ref.	Quadra	Torque (Nm)	Preço
T33025N	1/4"	5-25	94.00€
T33050N	3/8"	10-50	105.00€
T33101N	1/2"	20-100	105.00€
T33200N	1/2"	40-200	105.00€
T33341N	3/4"	60-340	139.00€



T10H1210S

302.00€

Jogo de chave dinamométrica com 7 chaves intermutáveis 14x18

Torque: 40-210 Nm



T103

Chave "Pata de Galo" 14x18

Ref.	Medida (mm)	Preço
T10313	13	11.00€
T10314	14	11.00€
T10315	15	11.00€
T10316	16	11.00€
T10317	17	11.00€
T10318	18	11.00€
T10319	19	11.00€
T10321	21	11.00€
T10322	22	11.00€
T10324	24	11.00€



T29002

19.00€

Cabeçote para chave dinamométrica de cabeças intermutáveis
Quadra: 1/4"
14/18mm



T29014

21.50€

Cabeçote para chave dinamométrica de cabeças intermutáveis
Quadra: 1/2"
14/18mm



T14100N 240.00€
Chave dinamométrica digital intermutável com precisão de: +/- 1%

Capacidade: 10-100Nm Memória: 10 leituras
 Comprimento: 420mm Unidade: Nm; fb-lb; Kg-m; in-lb
 Peso: 840g Pilhas: 3x1,5v AA (não incluídas)
 Cabeçote: 14x18

T14200N 250.00€
Chave dinamométrica digital intermutável com precisão de: +/- 1%

Capacidade: 20-200Nm Memória: 10 leituras
 Comprimento: 550mm Unidade: Nm; fb-lb; Kg-m; in-lb
 Peso: 1 150g Pilhas: 3x1,5v AA (não incluídas)
 Cabeçote: 14x18

T24135 299.00€
Chave dinamométrica digital reversível com aperto à esquerda e à direita
 Precisão de: +/- 2% à direita | +/- 3% à esquerda

Torque: 6,8-135Nm Quadra: 3/8"

T24200 330.00€
Chave dinamométrica digital com aperto à esquerda e à direita
 Precisão de: +/- 2% à direita | +/- 3% à esquerda

Capacidade: 10-200Nm Memória: 50 leituras
 Comprimento: 530mm Unidade: Nm; fb-lb; Kg-cm; in-lb
 Quadra: 1/2"

T19
Medidor digital de torque com precisão de: +/- 2%
 Com aviso luminoso e sonoro

Ref.	Quadra	Torque (Nm)	Preço
T19135N	3/8"	10-135	61.00€
T19200N	1/2"	20-200	62.00€

T
Kits de reparação para chaves dinamométricas

Ref.	Aplicáveis aos modelos	Preço
T04M060-R	T04M060	6.80€
T04M061-R	T04M061	6.80€
T04M150-R	T04M150	9.00€
T04M250-R	T04M250	12.00€
T07030N-R	T07030N	6.60€
T07110N-R	T07110N	7.20€
T07700N-R	T07700N	48.50€
T102001S-R	T102001S	11.60€
T154100N-R	T154100N	9.00€
T154200N-R	T154200N	13.80€
T16005N-R	T16005N	8.00€
T21025N-R	T21025N	8.70€
T21050N-R	T21050N	10.00€
T211000N-R	T211000N	56.50€
T21101N-R	T21101N	11.00€
T21200N-R	T21200N	11.50€
T21340N-R	T21340N	11.50€
T21341N-R	T21341N	40.00€
T21550N-R	T21550N	40.00€
T24135-R	T24135	18.00€
T24200-R	T24200	21.00€
T25100N-R	T25100N	10.00€
T25200N-R	T25200N	11.20€
T25340N-R	T25340N	11.20€
T27-D2R	T27010N, T27020N, T27030N	6.50€
T27-D3R	T27021N, T27031N, T27060N, T27100N	7.20€
T27-D4R1	T27101N	8.30€
T27-D4R2	T27200N, T27340N	9.70€
T27-D6R	T27500N, T27600N, T27800N, T271000N	23.80€
T27-D8R	T27801N, T271001N	39.50€
T33025N-R	T33025N	10.00€
T33050N-R	T33050N	11.50€
T33101N-R	T33101N	12.50€
T33200N-R	T33200N	12.50€
T33341N-R	T33341N	14.00€

R12
Roquete reversível de 60 dentes

Ref.	Quadra	Comp. (mm)	Preço
R1206N	3/4"	500	57.50€
R12081	1"	675	126.00€

R29
Roquete reversível de 36 dentes

Ref.	Quadra	Comp. (mm)	Preço
R2902	1/4"	146	11.60€
R2904	1/2"	278	17.50€



Ferramenta de aperto

R34



Roquete de 72 dentes com punho antideslizante

Ref.	Quadra	Comp. (mm)	Torque (Nm)	Preço
R3403	3/8"	196	245	19.30€

R35



Roquete de 72 dentes com punho antideslizante

Ref.	Quadra	Comp. (mm)	Torque (Nm)	Preço
R3502	1/4"	135	68	13.50€
R3503	3/8"	199	245	16.00€
R3504	1/2"	250	647	20.00€

R36



Roquete metálico reversível de 48 dentes

Ref.	Quadra	Comp. (mm)	Torque (Nm)	Preço
R3602	1/4"	128	68	13.00€
R3603	3/8"	198	245	16.00€

R37

Roquete reversível de 48 dentes com punho antideslizante

Ref.	Quadra	Comp. (mm)	Torque (Nm)	Preço
R3702	1/4"	135	68	13.20€
R3703	3/8"	198	245	16.70€
R3704	1/2"	353	647	19.50€



R37B



Roquete reversível curto de 48 dentes com punho antideslizante

Ref.	Quadra	Comp. (mm)	Torque (Nm)	Preço
R3702B	1/4"	110	68	12.90€
R3704B	1/2"	180	647	18.00€

R41



Roquete reversível e articulado de 36 dentes com punho antideslizante

Ref.	Quadra	Comp. (mm)	Preço
R4103	3/8"	238	17.50€
R4104	1/2"	288	22.40€

R45



Roquete reversível e rotativo de 48 dentes

Ref.	Quadra	Comp. (mm)	Preço
R4502	1/4"	185	29.30€

R48



Roquete metálico reversível de 72 dentes

Ref.	Quadra	Comp. (mm)	Preço
R4802A	1/4"	125	11.00€
R4804A	1/2"	250	17.70€

R48

Roquete curto reversível de 72 dentes

Ref.	Quadra	Comp. (mm)	Peso (g)	Preço
R4802B	1/4"	110	100	11.70€
R4804B	1/2"	170	442	17.10€

R51



Roquete reversível e extensível de 72 dentes com punho antideslizante

Ref.	Quadra	Comp. (mm)	Peso (g)	Preço
R5103	3/8"	220-230	440	19.00€
R5104	1/2"	300-400	930	23.50€

R66
Roquete com cabo rotativo de 60 dentes

Ref.	Quadra	Comp. (mm)	Peso (g)	Preço
R6602	1/4"	180	181	35.00€
R6603	3/8"	290	645	38.00€
R6604	1/2"	240	384	43.50€

R68
Roquete reversível de baixo perfil de 60 dentes

Ref.	Quadra	Peso (g)	Preço
R6802	1/4"	165	14.00€
R6803	3/8"	265	18.00€
R6804	1/2"	520	20.00€

RD01
13.50€
Mini roquete

 Quadra: 1/4"
 Dentes: 60
 Comprimento: 200mm

RD02
16.00€
Mini roquete flexível

 Quadra: 1/4"
 Dentes: 60
 Comprimento: 170mm

T094602
295.00€
Roquete desmultiplicador 1/2" - 3/4" R 1:9

Torque máximo: 1 500 Nm

T094602-RK
220.00€
Kit de reparação
T096801
320.00€
Roquete desmultiplicador 3/4" - 1" R 1:4

Torque máximo: 2 500 Nm

T096801-RK
215.00€
Kit de reparação
T351060
125.00€
Aparafusador de torque de 1 a 6Nm

Composição:

 Aparafusador: 1-6 Nm
 Adaptador 1/4"
 4 Bits phillips: PH0; PH1; PH2 e PH3
 4 Bits fenda: 3; 4; 5 e 6mm
 5 Bits torx: 10; 15; 20; 25 e 30
 6 Bits hexagonais: 1.5; 2; 3; 4; 5 e 6mm

R
Kits de reparação para roquetes

Ref.	Aplicáveis aos modelos	Preço
R1206N-R	R1206N	19.50€
R1206R	R1206	18.00€
R2902RK	R2902; R2902A; R2902B	5.30€
R2903RK	R2903; R2903A; R2903B ; R4103	5.90€
R2904RK	R2904; R2904A; R2904B ; R4104	6.70€
R3602RK	R3602; R3702; R3702B; R3802	7.00€
R3603RK	R3603; R3703; R3803	9.00€
R3604RK	R3604; R3704; R3704B; R3804	10.00€
R3402RK	R3402; R3502	7.00€
R3403RK	R3403; R3503	8.90€
R3404RK	R3404; R3504	9.90€
R4502RK	Para cabeça de roquete	6.50€
R4502JRK	Para articulação	6.50€
R4802RK	R4802	5.20€
R4804RK	R4804	6.20€
R5103RK	R5103	5.80€
R5104RK	R5104	7.70€
R5802ERK	R5802E	9.40€
R5803RK	R5803	11.50€
R5804ERK	R5804E	14.80€
R5804LRK	R5804L	14.80€
R6802RK	R68	8.80€
R6803RK	R68	10.70€
R6804RK	R68	12.00€
R12081RK	R12081	58.00€

W24A107S
86.50€
Jogo de chaves luneta aberta flexível

Composição:

Chaves: 8x8; 10x10; 11x11; 12x12; 13x13; 14x14 e 17x17

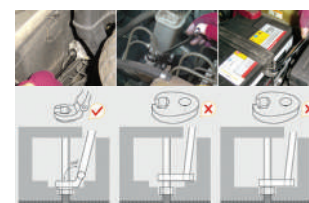

W45



Chave combinada boca/ roquete

Ref.	Medida (mm)	Comp. (mm)	Preço
W45108	8	135,40	7.70€
W45109	9	159,50	8.00€
W45110	10	159,50	8.10€
W45111	11	165,90	8.30€
W45112	12	168,60	8.50€
W45113	13	178,50	9.00€
W45114	14	190,50	9.50€
W45115	15	199,40	10.50€
W45116	16	206,40	10.90€
W45117	17	225,40	11.60€
W45118	18	236,40	13.00€
W45119	19	247,40	13.00€
W45121	21	281,00	19.90€
W45122	22	281,00	21.90€
W45124	24	281,00	22.50€
W45127	27	330,00	34.00€
W45130	30	425,00	47.00€
W45132	32	425,00	48.90€



W45110S

84.00€

Jogo de chaves de boca/ roquete de 9 peças

Composição:

- W45 Chaves: 8; 10; 12; 13; 17 e 19mm
- Adaptadores 1/4"; 3/8" e 1/2"
- Porta bits



W45117S

315.00€

Jogo de chaves combinadas boca/ roquete com 72 dentes de 17 peças

Composição:

- W45 Chaves: 8; 10; 12; 13; 14; 17; 19; 21; 22; 24; 27; 30 e 32mm
- Adaptadores 1/4"; 3/8"; 1/2" e 3/4"
- Porta bits
- Mala



W45316S

142.00€

Jogo de chaves combinadas boca/ roquete com 72 dentes de 16 peças

Composição:

- W45 Chaves: 8 a 19mm
- Adaptadores 1/4"; 3/8" e 1/2"
- Porta bits
- Mala



W45316S-AD

13.80€

Conjunto de 4 adaptadores

Composição:

- Adaptadores 1/4"; 3/8" e 1/2"
- Porta bits



W45316S-AD12

5.00€

Adaptador 1/2" para chave 19mm



W45316S-AD14

3.50€

Adaptador 1/4" para chave 10mm



W45316S-AD34

13.30€

Adaptador 3/4" para chave 32mm



W45316S-AD38

4.10€

Adaptador 3/8" para chave 13mm



W45316S-ADBH14

1.75€

Porta bits 1/4" para chave 10mm



W51110S

107.00€

Jogo de 10 chaves curtas boca/ roquete

Composição:

- W51 Chaves: 8; 10; 11; 12; 13; 14; 15; 16; 17 e 19mm

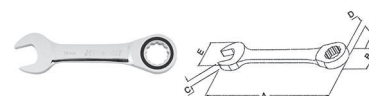

W52105S
75.00€
Jogo de 5 chaves curtas boca/ roquete flexível

Composição:

W52 Chaves: 8; 10; 12; 14 e 17mm

W66
Chave de boca/ roquete flexível

Ref.	Medida (mm)	Comp. (mm)	Preço
W66108	8	137	13.15€
W66109	9	159	13.25€
W66110	10	159	13.25€
W66111	11	175	14.20€
W66112	12	175	15.00€
W66113	13	186	15.00€
W66114	14	194	15.90€
W66115	15	216	16.60€
W66116	16	216	18.00€
W66117	17	232	18.00€
W66118	18	250	19.00€
W66119	19	250	19.60€
W66124	24		34.00€

W66107S
107.00€
Jogo de 7 chaves de boca/ roquete flexível

Composição:

W66 Chaves: 8; 10; 11; 13; 14; 17 e 19mm

W66116S
207.00€
Jogo de chaves combinadas boca/ roquete flexível de 72 dentes com 16 peças

Composição:

W66 Chaves: 8 a 19mm
 Adaptadores 1/4"; 3/8" e 1/2"
 Suporte de bit
 Mala

W67104S
56.00€
Jogo de chaves luneta (torx) com roquete

Composição:

 Chaves: E6xE8; E10xE12;
 E14xE18 e E20xE24mm

W68
Chave roquete de 72 dentes

Ref.	Medida (mm)	Preço
W680809	8x9	12.45€
W680810	8x10	12.60€
W681011	10x11	13.00€
W681213	12x13	13.50€
W681415	14x15	15.90€
W681618	16x18	16.90€
W681719	17x19	18.90€

W68106S
85.00€
Jogo de chaves roquete de 72 dentes com 6 peças

Composição:

W68 Chaves: 8x9; 10x11; 12x13;
 14x15; 16x18 e 17x19

W73
Chave 4 em 1 com roquete

Ref.	Medida (mm)		Preço
W7310813	8x10	12x13	19.40€
W7311419	14x17	18x19	24.50€

W73102S
42.00€
Jogo de chaves com roquete 4 em 1

Podendo ser utilizadas em 4 medidas

Composição/ medidas em mm:

 Chave 8x10 - 12x13
 Chave 14x17 - 18x19

W91107S

80.10€

Jogo de chaves combinadas boca especial/ roquete de 72 dentes

Composição:

Chaves: 10; 12; 13; 14; 15; 17 e 19mm



W91

Chave boca especial/ luneta com roquete



Ref.	Medida (mm)	Comp. (mm)	Preço
W91110	10	159,5	9.70€
W91112	12	168,6	10.00€
W91113	13	178,5	10.40€
W91114	14	190,5	11.10€
W91115	15	199,4	11.90€
W91117	17	225,4	13.30€
W91119	19	247,4	14.80€

W93108S

111.00€

Jogo de chaves mistas com roquete reversível e anel de retenção

Composição:

Chaves: 10; 11; 12; 13; 14; 15; 17 e 19mm



W93

Chave mista boca roquete com anel retenção



Ref.	Medida (mm)	Comp. (mm)	Preço
W93110	10	158	11.70€
W93111	11	164	12.20€
W93112	12	167	13.30€
W93113	13	177	13.80€
W93114	14	189,4	14.30€
W93115	15	198	15.30€
W93117	17	224	17.60€
W93119	19	245	19.90€

W61

Chave luneta longa



Ref.	Medida (mm)	Comp. (mm)	Preço
W611011	10x11	295	9.70€
W611214	12x14	330	11.20€
W611315	13x15	370	13.20€
W611618	16x18	405	14.80€
W611719	17x19	405	15.30€
W612224	22x24	435	21.90€

W61106S

92.00€

Jogo de 6 chaves luneta longas

Fornecido em bolsa plástica com divisórias

Composição:

Medida	Comp. (mm)
10x11	235
12x14	330
13x15	370
16x18	405
17x19	405
22x24	435



W62

Chave luneta direita



Ref.	Medida (mm)	Comp. (mm)	Preço
W6210607	6x7	120	3.55€
W6210809	8x9	135	3.90€
W6211011	10x11	150	4.10€
W6211213	12x13	165	4.60€
W6211415	14x15	210	5.10€
W6211617	16x17	210	5.90€
W6211819	18x19	225	6.10€
W6212022	20x22	240	7.15€
W6212427	24x27	270	11.70€
W6212528	25x28	285	12.70€
W6213032	30x32	335	14.80€

W62108S

45.00€

Jogo de 8 chaves luneta direita

Composição:

W62 Chaves: 6x7; 8x9; 10x11; 12x13; 14x15; 16x17; 18x19 e 20x22mm



W23
Chave luneta 75°

Ref.	Medida (mm)	Preço
W230607	6x7	3.45€
W230809	8x9	3.55€
W231011	10x11	4.30€
W231213	12x13	4.70€
W231415	14x15	5.40€
W231617	16x17	5.90€
W231819	18x19	6.90€
W232022	20x22	8.40€
W232123	21x23	9.50€
W232426	24x26	11.00€
W232427	24x27	11.00€
W232528	25x28	11.40€
W233032	30x32	13.30€

W23108S
51.00€
Jogo de 8 chaves luneta 75°

Fornecido em bolsa plástica com divisórias

Composição:

W23 Chaves: 6x7; 8x9; 10x11; 12x13; 14x15; 16x17; 18x19 e 20x22mm

W24
Chave luneta aberta

Ref.	Medida (mm)	Faces	Preço
W240809	8x9	6	2.85€
W241011	10x11	6	3.10€
W241012	10x12	6	3.10€
W241314	13x14	6	3.60€
W241417	14x17	6	4.80€
W241617	16x17	12	5.10€
W241719	17x19	12	5.70€
W241819	18x19	12	6.10€
W241922	19x22	12	7.40€
W242528	25x28	12	11.60€
W243032	30x32	12	12.70€

W24106S
31.00€
Jogo de 6 chaves luneta aberta

Fornecido em bolsa plástica com divisórias

Composição:

W24 Chaves: 8x9; 10x11; 10x12; 13x14; 16x17 e 17x19mm

W24N
Chave luneta aberta com batente

Ref.	Medida (mm)	Comp. (mm)	Preço
W24N0810	8x10	122	6.60€
W24N1113	11x13	143	7.65€
W24N1214	12x14	145	7.90€
W24N1719	17x19	162	11.00€

W25
Chave de bocas

Ref.	Medida (mm)	Preço
W250607	6x7	2.00€
W250608	6x8	2.15€
W250809	8x9	2.20€
W251011	10x11	2.40€
W251012	10x12	2.50€
W251213	12x13	2.75€
W251415	14x15	3.15€
W251417	14x17	3.55€
W251617	16x17	3.65€
W251719	17x19	4.30€
W251819	18x19	4.30€
W252022	20x22	5.40€
W252123	21x23	5.70€
W252426	24x26	7.00€
W252427	24x27	7.20€
W252528	25x28	8.60€
W252730	27x30	9.70€
W252732	27x32	10.00€
W253032	30x32	10.20€
W253236	32x36	17.75€
W253641	36x41	24.50€
W253842	38x42	25.00€
W254146	41x46	36.75€
W254650	46x50	50.00€

W25108S
34.00€
Jogo de 8 chaves de bocas

Fornecido em bolsa plástica com divisórias

Composição:

W25 Chaves: 6x7; 8x9; 10x11; 12x13; 14x15; 16x17; 18x19 e 20x22mm

W26

Chave de bocas/ luneta

Ref.	Medida (mm)	Preço
W26106	6	1.85€
W26107	7	1.95€
W26108	8	2.00€
W26109	9	2.10€
W26110	10	2.20€
W26111	11	2.30€
W26112	12	2.45€
W26113	13	2.70€
W26114	14	2.90€
W26115	15	3.20€
W26116	16	3.25€
W26117	17	3.90€
W26118	18	4.30€
W26119	19	4.60€
W26120	20	5.20€
W26121	21	5.60€
W26122	22	5.70€
W26123	23	6.20€
W26124	24	6.60€
W26125	25	7.20€
W26126	26	7.70€
W26127	27	8.20€
W26128	28	8.70€
W26129	29	9.40€
W26130	30	10.00€
W26132	32	11.00€
W26134	34	19.40€
W26136	36	23.90€
W26138	38	29.80€
W26141	41	35.00€
W26142	42	36.00€
W26144	44	44.90€
W26146	46	45.90€
W26148	48	61.70€
W26150	50	62.20€
W26155	55	104.00€
W26160	60	135.00€
W26165	65	178.00€

W26
Jogo de chaves de boca/ luneta

Fornecido em bolsa plástica com divisórias

Ref.	Chaves	Medida (mm)	Preço
W26112S	12xW26	8 a 17; 19 e 22	47.00€
W26114S	14xW26	10 a 14; 16; 17; 19; 21; 22; 24; 27; 30 e 32	81.50€
W26126S	26xW26	6 a 32	146.00€

W26411PRS

55.00€

Jogo de 11 chaves mistas longas

Fornecido em bolsa plástica com divisórias

Composição:

W264 Chaves: 7; 8; 9; 10; 11; 12; 13; 14; 15; 17 e 19mm

W26414S

127.00€

Jogo de 14 chaves mistas boca/ luneta SAE

Fornecido em bolsa plástica com divisórias

Composição:

W26 Chaves: 3/8"; 7/16"; 1/2"; 9/16"; 5/8"; 11/16"; 13/16"; 7/8"; 15/16"; 1"; 1-1/16"; 1-1/8"; 1-1/4"

W29

Chave luneta para parafusos torx

Ref.	Medida	Comp. (mm)	Preço
W290608	E6xE8	112	5.30€
W290711	E7xE11	125	6.20€
W291012	E10xE12	140	6.20€
W291418	E14xE18	180	6.20€
W291622	E16xE22	200	6.90€
W292024	E20xE24	224	6.90€

W39

Chave de bocas de perfil fino

Ref.	Medida (mm)	Comp. (mm)	Preço
W391011	10x11	175	4.60€
W391213	12x13	210	5.60€
W391415	14x15	210	5.60€
W391617	16x17	250	8.20€
W391819	18x19	250	8.20€

W39108SA

68.00€

Jogo de 8 chaves de bocas de perfil fino

Composição:

W39 Chaves: 6x7; 8x9; 10x11; 12x13; 14x15; 16x17; 18x19 e 20x22mm

W69116S

119.50€

Jogo de 16 chaves mistas 75°

Composição:

W69 Chaves: 7; 8; 9; 10; 11; 12; 13; 14; 15; 16; 17; 18; 19; 21; 22 e 24mm

S57

Chaves de cachimbo



Ref.	Medida (mm)	Preço
S57H108	8	6.90€
S57H109	9	8.20€
S57H110	10	8.70€
S57H111	11	8.80€
S57H112	12	10.20€
S57H113	13	13.50€
S57H115	15	13.60€
S57H116	16	14.20€
S57H117	17	15.50€
S57H118	18	16.00€
S57H119	19	16.40€
S57H121	21	23.00€
S57H122	22	29.00€
S57H123	23	29.50€
S57H124	24	33.00€
S57H125	25	33.60€
S57H127	27	42.00€
S57H132	32	57.50€

S57H108S

99.00€

Jogo de 8 chaves de cachimbo

Fornecido em bolsa plástica com divisórias

Composição:

S57 Chaves: 8; 10; 11; 13; 16; 17; 18 e 19mm

W65

Chave curva luneta para motores de arranque



Ref.	Medida (mm)	Preço
W6510810	8x10	3.15€
W6511012	10x12	3.70€
W6511315	13x15	4.10€
W6511417	14x17	5.10€
W6511922	19x22	6.20€

W65A

Chave curva luneta



Ref.	Medida	Comp. (mm)	Preço
W65A1012	10x12	141	6.80€
W65A1214	12x14	166	8.45€
W65A1315	13x15	190	10.90€
W65A1618	16x18	220	12.75€
W65A1719	17x19	220	13.00€
W65A1922	19x22	256	15.30€
W65A2224	22x24		19.00€

W65A105S

54.00€

Jogo de 5 chaves curvas luneta

Composição:

W65A Chaves: 10x12; 12x14; 13x15; 16x18 e 17x19mm

W43A

Chave de caixa flexível



Ref.	Medida (mm)	Comp. (mm)	Preço
W43A0607	6x7	180	5.10€
W43A0809	8x9	180	5.10€
W43A1011	10x11	202	5.50€
W43A1213	12x13	222	6.50€
W43A1415	14x15	245	7.55€
W43A1617	16x17	260	8.55€
W43A1819	18x19	280	10.00€

W43A106S

47.50€

Jogo de 6 chaves de caixa flexíveis

Composição:

W43A Chaves: 8x9; 10x11; 12x13; 14x15; 16x17 e 18x19mm
Mala

Ferramenta de aperto

W77A

Chave luneta 70° para extensão

Utiliza extensão da série W77H



Ref.	Medida (mm)	Comp. (mm)	Preço
W77A124	24	180	17.90€
W77A127	27	190	20.70€
W77A130	30	200	24.00€
W77A132	32	235	28.00€
W77A136	36	245	33.60€
W77A138	38	245	34.70€
W77A141	41	265	40.30€
W77A146	46	280	47.00€
W77A150	50	290	50.00€
W77A155	55	300	73.50€
W77A160	60	345	97.00€
W77A165	65	355	117.40€

W77H

Extensão para chave W77A

Utilizável em conjunto com as chaves da série W77A



Ref.	Medida (mm)	Utilizar em (mm)	Preço
W77H01	480	24~30	22.50€
W77H02	610	32~41	34.70€
W77H03	760	46~55	60.20€
W77H04	860	60~65	76.50€

WFS46

29.00€

Chave para filtro diferencial

Inclui chave hexagonal de 5mm

Medida: 46mm

Estriado de 12 faces

Aplicação: VW: Bora, Golf IV, Sharan

Skoda: Octavia



W67

Chave de boca pancada



Ref.	Medida (mm)	Comp. (mm)	Preço
W67119	19	177	5.20€
W67121	21	177	5.30€
W67124	24	197	6.40€
W67130	30	243	10.20€
W67132	32	273	13.00€
W67136	36	299	18.50€
W67138	38	299	18.90€
W67141	41	339	25.00€
W67145	45	374	30.90€
W67146	46	374	31.00€
W67150	50	417	42.00€
W67155	55	496	57.00€
W67160	60	496	58.00€
W67165	65	496	59.00€
W67170	70	496	99.00€

W72

Chave de luneta pancada



Ref.	Medida (mm)	Comp. (mm)	Preço
W72117	17	160	8.10€
W72118	18	160	8.30€
W72119	19	160	8.40€
W72121	21	160	8.60€
W72122	22	163	9.20€
W72124	24	163	9.25€
W72127	27	180	9.30€
W72130	30	190	13.30€
W72132	32	190	13.35€
W72134	34	205	18.40€
W72136	36	205	19.40€
W72141	41	230	23.50€
W72146	46	240	30.50€
W72150	50	255	40.80€
W72155	55	360	55.00€
W72170	70	335	127.50€

W27AL

Chave inglesa

Maior capacidade de abertura, mais fina e mais leve



Ref.	Medida (mm)	Abertura (mm)	Peso (mm)	Comprimento (mm)	Preço
W27AL10	250	43	277	256	28.00€

W27AR

Chave inglesa



Ref.	Abertura (mm)	Comp. (mm)	Preço
W27AR8	26,9	200	24.50€
W27AR10	34	250	30.60€



ON: funciona como roquete

OFF: funciona como chave inglesa

W27AS

Chave inglesa



Ref.	Abertura (mm)	Comp. (mm)	Preço
W27AS8	20	150	13.50€
W27AS10	29	250	16.20€
W27AS15	43	380	43.50€
W27AS18	53	450	70.00€

W27AT

Chave ajustável com cabo antidesslizante



Ref.	Medida (mm)	Comp. (mm)	Preço
W27AT8	24	200	19.00€
W27AT10	29	250	23.00€
W27AT12	34	300	27.70€
W27AT15	43	375	53.50€

W27AK8

28.50€

Chave inglesa duplo sistema (métrico/SAE)

Comprimento: 200mm

W28HD

Chave bico de falcão para tubos



Ref.	Abertura (mm)	Comp. (mm)	Preço
W28HD8	10-22	200	29.50€
W28HD10	12-30	250	33.50€

W28

Chave para tubos



Ref.	Abertura (mm)	Comp. (mm)	Preço
W2808	25,5	200	15.20€
W2810	38	250	16.80€
W2812	51	300	22.00€
W2814	51	350	26.00€
W2818	63,5	450	39.30€
W2824	76	600	63.50€
W2836	127	900	143.00€

W28RJ-HL

Garras de substituição



Ref.	Aplicável modelo	Preço
W2810RJ-HL	W2810	5.40€
W2812RJ-HL	W2812	6.50€
W2814RJ-HL	W2814	7.15€
W2818RJ-HL	W2818	9.60€
W2824RJ-HL	W2824	14.00€
W2836RJ-HL	W2836	29.50€

Ferramenta de aperto

Ferramenta SUPERTECH

S68H2141S

49.90€

Jogo de 41 peças de 1/4" SUPERTECH

Composição/ medidas em mm:

R2902 Roquete de 36 dentes
 Chaves caixa: 4; 4,5; 5; 5,5; 6; 7; 8; 9; 10; 11; 12; 13 e 14
 Chaves hexagonais: 1,5; 2 e 2,5
 20 Bits
 Extensão de 50
 Cabo "T" corrediço
 Adaptador hexagonal
 Punho



Adapta-se a 7 tipos de parafusos

S68H4127S

116.00€

Jogo de 27 peças de 1/2" SUPERTECH

Composição/ medidas em mm:

R2904 Roquete de 36 dentes
 Chaves caixa: 8 a 24; 27; 30 e 32
 Chaves de velas: 16 e 21
 Cardan
 Extensão de 125 e 250
 Cabo "T" corrediço



Adapta-se a 7 tipos de parafusos

S68H
Chave de caixa 1/4" SUPERTECH

Ref.	Medida (mm)	SAE	Torque	Preço
S68H2103	3	1/8"	E4	0.75€
S68H2104	4	5/32"	E5	0.75€
S68H21045	4,5			0.80€
S68H2105	5	3/16"	E6	0.80€
S68H21055	5,5	7/32"	E7	0.80€
S68H2106	6		E8	0.85€
S68H21065	6,5	1/4"	E8	0.85€
S68H2107	7	9/32"		0.85€
S68H2108	8	5/16"	E10	0.90€
S68H2109	9	11/32"	E11	0.90€
S68H2110	10	3/8"	E12	0.90€
S68H2111	11	7/16"	E14	0.95€
S68H2112	12	15/32"		0.95€
S68H2113	13	1/2"	E16	0.95€
S68H2114	14	9/16"	E18	1.15€



Adapta-se a 7 tipos de parafusos

S68H5234111S

295.00€

Jogo de 111 peças de 1/4", 3/8" e 1/2" SUPERTECH

Composição/ medidas em mm:

R3702 Roquete de 1/4"
R3703 Roquete de 3/8"
R3704 Roquete de 1/2"
 Chaves caixa de 1/4": 3,2 a 13
 Chaves caixa de 3/8": 9 a 19
 Chaves caixa de 1/2": 14 a 32
 Chaves de velas de 3/8": 14 e 18
 Chaves de velas de 1/2": 16 e 21
 Chaves hexagonais: 1,5; 2 e 2,5
 Chaves mistas boca/ luneta: 8 a 19
 Bits de 1/4" fenda/ phillips/ torx/ hexagonal/pozi
 Bits de 5/16" fenda/ phillips/ torx/ hexagonal/pozi
 Adaptador bits 5/16"
 Cardan de 1/4"; 3/8" e 1/2"
 Extensões de 1/4" com 50 e 150
 Extensões de 3/8" com 75 e 150
 Extensões de 1/2" com 125 e 250
 Adaptador "T" para extensões
 Punho

W84108S

53.00€

Jogo de 8 chaves mistas boca/ luneta SUPERTECH

Chaves: 8; 10; 11; 12; 13; 14; 17 e 19mm

W84114S

82.50€

Jogo de 14 chaves mistas boca/ luneta SUPERTECH

Chaves: 6 a 19mm

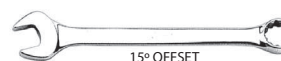

15° OFFSET



Adapta-se a 7 tipos de parafusos



Ferramenta SUPERTECH

W84

Chave mista boca/ luneta SUPERTECH



Ref.	Medida (mm)	Preço
W84106	6	3.90€
W84107	7	4.00€
W84108	8	4.10€
W84109	9	4.30€
W84110	10	4.60€
W84111	11	4.80€
W84112	12	5.10€
W84113	13	5.60€
W84114	14	5.80€
W84115	15	6.60€
W84116	16	7.15€
W84117	17	7.70€
W84118	18	8.15€
W84119	19	9.15€

W86112S

193.00€

Jogo de 12 chaves boca/ roquete SUPERTECH

Chaves: 8 a 19mm



Adapta-se a 7 tipos de parafusos



S03H2327S

59.50€

Jogo de chaves e bits de caixa de 1/4" com 27 peças

Composição/ medidas em mm:

- Chave mista boca/roquete
- Mini chaves 13mm: 4; 4,5; 5; 5,5; 6; 7; 8; 9; 10; 11; 12; 13 e 14
- Bits caixa hexagonais: 3; 4; 5 e 6mm
- Bits caixa phillips: PH1; Ph2 e Ph3
- Bits caixa fenda: 5,5 e 7mm
- Cardan
- Extensão 50mm
- Cabo "T" corrediço 115mm



Ferramenta de aperto

S04H2118S

33.50€

Jogo de chaves de caixa de 1/4" com 18 peças

Composição/ medidas em mm:

- R2902 Roquete de 36 dentes
- S04H2 Chaves caixa: 4; 4,5; 5; 5,5; 6; 7; 8; 9; 10; 11; 12 e 13
- S24H2 Extensões de 2" e 4"
- S23H2 Cabo "T" corrediço
- S15H240 Adaptador universal
- S22H2130 Punho flexível



S04H2141S

65.00€

Jogo de chaves de caixa de 1/4" com 41 peças

Composição/ medidas em mm:

- R3702 Roquete de 48 dentes
- S04H2 Chaves caixa: 4; 5; 5,5; 6; 7; 8; 10; 11; 12 e 13
- S04HD2 Chaves longas de caixa: 7; 8 e 10
- Chaves macho hexagonais: 1,5; 2; 2,5 e 3
- S09H2 Bits hexagonais: 3; 4; 5 e 6
- S07H2 Bits torx: T10; T20; T25; T27; T30 e T40
- S10H2 Bits fenda: 0,8x4; 10x5,5 e 1,2x7
- S11H2 Bits phillips: PH1; PH2 e PH3
- S24H Extensões de 2" e 6"
- S28H1 Punho
- S15H240 Adaptador universal
- S27H2150 Extensão flexível 6"
- S16H3814 Adaptador 3/8 (F) x 1/4" (M)
- Caixa metálica



S04H3125S

67.50€

Jogo de chaves de caixa de 3/8" com 25 peças

Composição/ medidas em mm:

- R3703 Roquete de 48 dentes
- Chaves caixa: 6 a 22
- Chaves de velas: 16 e 21
- S24H Extensões de 75 e 150
- S23H31200 Cabo "T" corrediço de 200
- S15H356 Cardan
- Caixa metálica



S04H3141S

109.00€

Jogo de chaves de caixa de 3/8" com 40 peças

Composição/ medidas em mm:

- R3703** Roquete de 48 dentes
S04H3 Chaves caixa: 6 a 24
 Chaves de caixa longas: 14; 15; 17 e 19
 Bits torx: T10; T20; T25; T27; T30; T40; T45 e T50
 Bits fenda: 0,8x4; 1x5,5 e 1,2x8
 Bits phillips: PH1; PH2 e PH3
 2 Extensões
 Cardan
 Adaptador universal
 Mala de transporte

S04H3157S

125.00€

Jogo de chaves de caixa de 1/4" e 3/8" com 56 peças

Composição/ medidas em mm:

- R3702** Roquete 1/4" de 48 dentes
R3703 Roquete 3/8" de 48 dentes
S04H2 Chaves de 1/4": 4; 4,5; 5; 5,5; 6; 7; 8; 9; 10; 11; 12 e 13
S04HD2 Chaves longas de 1/4": 8; 10; 12; e 13
S04H3 Chaves de 3/8": 14; 15; 17; 18; 19; 20; 22 e 24
S04HD3 Chaves longas 3/8": 14; 15; 17
S17H3 Chaves velas 3/8": 16 e 21
S09H2 Bits hexagonais: 3; 4; 5 e 6
S07H2 Bits torx: T10; T15; T20; T25; T27 e T30
S10H2 Bits fenda: 4; 5,5 e 7
S11H2 Bits phillips: PH1; PH2 e PH3
S24H2 2 Extensões 1/4" (50mm + 150mm)
S24H3 2 Extensões 3/8" (75mm + 250mm)
S16H302 Adaptador de extensão 1/4" - 3/8"
S16H403 Adaptador de extensão 1/2" - 3/8"
S15H356 Adaptador universal 3/8"
S15H240 Adaptador universal 1/4"
S26H2150 Punho

S04H3536S

97.00€

Jogo de chaves de caixa de 3/8" com 36 peças

Composição/ medidas em mm:

- R3503** Roquete de 72 dentes
 Chaves caixa: 6 a 22mm
 Chaves mistas: 7 a 17mm
 Chaves de velas: 16 e 21mm
 Extensões de 75; 150 e 225mm
 Cardan
S16H403 Adaptador
 Caixa metálica

S04H4125S

88.00€

Jogo de chaves de caixa de 1/2" com 25 peças

Composição/ medidas em mm:

- R3704** Roquete de 48 dentes
S04H4 Chaves caixa: 10 a 24; 27; 30 e 32
S04H4 Chaves de velas: 16 e 21
 Extensões de 5" e 10"
 Cabo "T" correção
 Adaptador universal
 Mala de transporte

S04H4524S

98.00€

Jogo de chaves de caixa de 1/2" com 24 peças

Composição/ medidas em mm:

- R3704** Roquete de 48 dentes
S04H4 Chaves caixa: 10 a 24; 27; 30 e 32
S24H4 Extensões de 5" e 10"
S23H41300 Cabo "T" correção
S15H472 Adaptador universal
S22H41375 Punho flexível 15"
 Caixa metálica

S04H4728S

97.00€

Jogo de chaves de caixa sextavadas de 1/2" com 28 peças

Composição/ medidas em mm:

- R3704** Roquete de 48 dentes
S04H4 Chaves caixa: 8 a 28; 30; 32 e 34
S24H4250 Extensão 10"
S23H41300 Cabo "T" correção
S15H472 Adaptador universal
 Caixa metálica

S04H6115S

157.00€

Jogo de chaves de caixa de 3/4" com 14 peças

Composição/ medidas em mm:

- Roquete
 Chaves caixa: 22; 24; 27; 30; 32; 36; 38; 41; 46 e 50
 Extensão de 100 e 200
 Cabo "T" correção



S04H6321S

258.00€

Jogo de chaves de caixa de 3/4" com 20 peças

Composição/ medidas em mm:

- R1206N Roquete reversível de 500
- S04H61 Chaves caixa: 19; 21; 22; 24; 27; 30; 32; 36; 38; 41; 46 e 50
- S24H6 Extensão de 100; 200 e 400
- S22H6475 Cabo articulado 475
- S16H3412 Adaptador 3/4"F para 1/2"M
- S16H3410 Adaptador 3/4"F para 1"M
- S15H6109 Adaptador universal
- Mala de transporte



S04H8115S

505.00€

Jogo de chaves de caixa de 1" com 14 peças

Composição/ medidas em mm:

- Roquete
- Chaves caixa: 36; 41; 46; 50; 55; 60; 65; 70; 75 e 80
- Extensão de 200 e 400
- Cabo de 550



S06H425S

44.50€

Jogo de 25 bits torx de 1/2" e 1/4"

Composição/ medidas em mm:

- S07H2 Bits torx de 1/4": T8; T10; T15; T20; T25; T27 e T30x32
- S07H3 Bits torx de 1/2": T40; T45; T50; T55 e T60x55
- S06H2 Chaves parafusos torx 1/4": E4; E5; E6; E7 e E8
- S06H4 Chaves parafusos torx 1/2": E10; E11; E12; E14 e E18
- H08 Chaves macho torx: T6; T8 e T10



S06H4127S

92.50€

Jogo de 27 bits de 1/2" e 3/8"

Composição/ medidas em mm:

- S09H4 Bits hexagonais de 1/2": 4; 5; 6; 7; 8; 10 e 12x55; 14x60; 17x70; 8x80 e 10x140
- S49H4 Bits estriados de 1/2": M5; M6; M8; M10; M12; M14; M16x55; M10; M12x110 e M8x120
- S09H3 Bits hexagonais de 3/8": 4; 5; 6; 7; 8 e 10x48



S07H4109S

28.00€

Jogo de 9 chaves bits torx de 1/2"

Composição:

- T20; T25; T27; T30; T40; T50; T55 e T60



S07H4932S

115.00€

Jogo de 32 chaves bits torx de 1/2"

Composição:

- Bits 55mm: T20; T25; T27; T30; T40; T45; T50; T55; T60 e T70
- Bits 100mm: T20; T25; T27; T30; T40; T45; T50; T55; T60 e T70
- Bits 140mm: T40; T45; T50; T55; T60 e T70
- Bits 200mm: T40; T45; T50; T55; T60 e T70
- Mala de transporte



S09H4109S

30.00€

Jogo de 9 chaves bits hexagonais de 1/2"

Composição:

- H3; H4; H5; H6; H7; H8; H10; H12 e H14



S63H4132S

112.00€

Jogo de 32 chaves bits de 6 caneluras (Ribe) 1/2"

Composição:

- Bits 55mm: M5; M6; M7; M8; M9; M10; M12; M13 e M14
- Bits 100mm: M5; M6; M7; M8; M9; M10; M12; M13 e M16
- Bits 140mm: M8; M9; M10; M12; M13 e M14
- Bits 200mm: M8; M9; M10; M12; M13 e M14
- Mala de transporte



S64H4126S

94.00€

Jogo de 26 chaves bits ZZN 1/2"

Composição:

- Bits 55mm: M5; M6; M8; M10; M12; M14 e M16
- Bits 100mm: M5; M6; M8; M10; M12 e M14
- Bits 140mm: M5; M6; M8; M10; M12 e M14
- Bits 200mm: M8; M10; M12 e M14
- Mala de transporte



S04H52477S

179.00€

Jogo de 77 peças de ferramenta de 1/2" e 1/4"

Composição/ medidas em mm:

- R2904 Roquete 1/2" reversível de 36 dentes
 - R2902 Roquete 1/4" reversível de 36 dentes
 - S04H4 Chaves caixa 1/2": 12 a 32
 - S04H21 Chaves caixa 1/4": 4 a 12
 - S04HD21 Chaves de caixa longas 1/4": 8; 10; 12 e 13
 - S17H Chaves de velas 1/2": 16 e 21mm
 - W26 Chaves boca/ luneta: 8; 10; 12; 13; 14; 15; 17 e 19
 - D04 Jogo de chaves fenda
 - S24H Extensões 1/2" de 125 e 250
 - S24H275 Extensão 1/4" com 75
 - S15H472 Adaptador universal 1/2"
 - S15H240 Adaptador universal 1/4"
 - S16H304 Adaptador 3/8"F para 1/2"M
 - S23H21130 Cabo "T" correção 1/4"
 - P2810 Alicates ajustáveis
 - P088 Alicates universais
 - M09500 Martelo de mecânico tipo "Alemão" 500g
- Mala de transporte



S04H52460S

137.00€

Jogo de 60 peças de ferramenta de 1/2" e 1/4"

Composição/ medidas em mm:

- Roquete 1/2" de 36 dentes
- Chaves caixa 1/2": 12; 13; 14; 15; 17; 18; 19; 22 e 24
- Chaves caixa 1/4": 6; 8; 9; 10; 11; 12 e 13
- Chaves de velas 1/2": 16 e 21
- Chaves mistas: 8; 10; 12; 13; 14 e 17
- Jogo de chaves fenda/ phillips
- Bits de 1/4": fenda, torx e phillips
- Porta bits de 1/4"
- Extensões 1/2" de 125 e 250
- Extensão 1/4" com 75
- Extensão flexível de 1/4"
- Adaptador 3/8"F para 1/2"M
- Cabo "T" correção 1/4"
- Alicate ajustável
- Alicate universal
- Pontas de 1/4"
- Martelo
- Cardan de 1/2"
- Punho de 1/4"



S04H52478S

215.00€

Jogo de 78 peças de ferramenta de 1/2" e 1/4"

Composição/ medidas em mm:

- Roquete 1/2" de 48 dentes
- Roquete 1/4" de 48 dentes
- Chaves caixa 1/4": 5 a 11
- Chaves caixa longas 1/4": 5 a 12
- Chaves de velas 1/2": 16 e 21
- Chaves caixa 1/2": 12 a 19; 22; 24; 27 e 32
- Chaves mistas: 6 a 17; 19; 21; 22 e 24
- Chaves allen hexagonais: 2,5 a 10
- Chaves allen torx: T10; T15; T20; T25; T27; T30 e T40
- Chaves luneta aberta: 8x10; 11x13; 12x14 e 17x19
- Jogo de chaves fenda/ phillips
- Extensões 1/2" de 125 e 250
- Extensão 1/4" com 50
- Adaptador 3/8"F para 1/2"M
- Cabo "T" correção 1/4"
- Alicate de pressão
- Cardan de 1/2" e 1/4"
- Punho de 1/4"



S04H524127S
370.00€
Jogo de 127 peças de ferramenta de 1/2" e 1/4"

Composição/ medidas em mm:

- R2904 Roquete 1/2" reversível de 36 dentes
- R2902 Roquete 1/4" reversível de 36 dentes
- Chaves caixa 1/2": 8 a 11; 13 a 19; 21; 22; 24; 27; 30 e 32
- Chaves caixa 1/4": 4; 4,5; 5; 5,5; 6 a 13
- Chaves caixa longa 1/2": 10; 12; 13; 14; 15; 17 e 19
- Chaves caixa longa 1/4": 7; 8; 10; 12 e 13
- Chaves de velas 1/2": 16 e 21
- Chaves caixa torx 1/4": E4; E5; E6; E7 e E8
- Chaves torx 1/2": E10; E12; E14; E16; E18; E20; E22 e E24
- Chaves mistas: 6 a 17; 19; 21; 22; 24; 27; 30 e 32
- Chaves luneta aberta: 8x10; 9x11; 12x13; 14x17 e 17x19
- Chaves hexagonais curtas: 1,5; 2; 2,5; 3; 4; 5; 6; 8 e 10
- Chaves torx: T10; T15; T20; T25; T27; T30 e T40
- Chaves fendas com punho antideslizante
- Chaves phillips com punho antideslizante
- Jogo de punções e escopros
- S21H Extensões 1/4" de 50x150 e de 1/2" 50mm
- S24H Extensões 1/2" de 125 e 250 e de 1/4" de 75
- Extensão flexível 1/4" de 145
- Cabo "T" correção 1/4" de 130 e 1/2" de 250
- Cabo articulado 1/2" de 375
- P2810 Alicata ajustável
- P8606 Alicata de corte
- P8007 Alicata universal
- AG010034 Caneta magnética
- M09500 Martelo de mecânico tipo "Alemão" 500g
- Cardan de 1/2" e 1/4"
- Mala de transporte

S04H624101S
250.00€
Jogo de 101 peças de ferramenta de 1/2" e 1/4"

Composição/ medidas em mm:

- R2904 Roquete 1/2" reversível de 36 dentes
- R2902 Roquete 1/4" reversível de 36 dentes
- S04H4 Chaves caixa sextavadas 1/2": 8 a 24; 27; 30 e 32
- S04H2 Chaves caixa sextavadas 1/4": 4; 4,5; 5; 5,5; 6; 7; 8; 9 e 10
- S17H4 Chaves de velas 1/2": 16 e 21
- S06H4 Chaves caixa torx 1/2": E11; E12; E14; E16 e E18
- W24 Chaves luneta aberta: 8x10; 11x13; 12x14 e 17x19
- W26 Chaves boca/ luneta: 8; 10 a 19; 21; 22 e 24
- D04 Jogo de chaves fenda
- S24H4 Extensões 1/2" de 125 e 250
- S21H4 Extensão 1/2" de 50
- S24H2 Extensões 1/4" de 75 e 100
- S27H4 Extensão flexível 1/4"
- S14H4 Adaptador universal 1/2"
- S15H2 Adaptador universal 1/4"
- S23H2 Cabo "T" correção 1/4"
- S23H4 Cabo "T" correção 1/2"
- W27AS8 Alicata ajustável
- P087 Alicata universal
- AG010034 Caneta magnética
- Pontas de 1/4"
- Pontas XZN - M6; M8; M10 e M12
- Mala de transporte



S04H21

Chave de caixa sextavada 1/4"

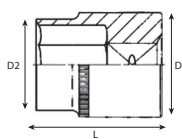

Ref.	Medida (mm)	D1 (mm)	D2 (mm)	L (mm)	Preço
S04H2104	4	11,8	6,8	25	0.75€
S04H21045	4,5	11,8	7,3	25	0.75€
S04H2105	5	11,8	8	25	0.75€
S04H21055	5,5	11,8	8,6	25	0.80€
S04H2106	6	11,8	9,2	25	0.80€
S04H2107	7	11,8	10,5	25	0.80€
S04H2108	8	11,4	11,7	25	0.85€
S04H2109	9	11,6	12,7	25	0.90€
S04H2110	10	12,8	13,7	25	0.90€
S04H2111	11	14,4	15,7	25	0.95€
S04H2112	12	13,7	16,6	25	0.95€
S04H2113	13	13,9	17,6	25	1.00€
S04H2114	14	17,5	20	25	1.10€

S04HD21

Chave de caixa sextavada longa 1/4"

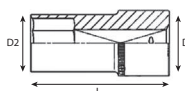

Ref.	Medida (mm)	D1 (mm)	D2 (mm)	L (mm)	Preço
S04HD2106	6	12	9,2	50	1.25€
S04HD2107	7	12	10,5	50	1.30€
S04HD2108	8	11,5	12	50	1.35€
S04HD2110	10	13,3	14,4	50	1.40€
S04HD2111	11	14,8	15,9	50	1.45€
S04HD2112	12	15,8	17	50	1.55€
S04HD2113	13	16,8	17,8	50	1.65€

S04H31

Chave de caixa sextavada 3/8"

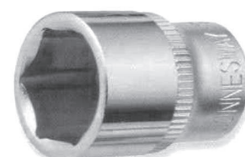
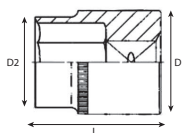

Ref.	Medida (mm)	D1 (mm)	D2 (mm)	L (mm)	Preço
S04H3106	6	16,8	9,6	28	1.05€
S04H3107	7	16,8	10,7	28	1.05€
S04H3108	8	16,8	12	28	1.05€
S04H3109	9	16,8	13,3	28	1.05€
S04H3110	10	16,8	14,4	28	1.05€
S04H3111	11	16,8	15,8	28	1.10€
S04H3112	12	16	16,8	28	1.10€
S04H3113	13	18	19	28	1.10€
S04H3114	14	18,8	19,7	28	1.10€
S04H3115	15	19,8	20,8	28	1.15€
S04H3116	16	20,8	22	28	1.20€
S04H3117	17	22	23,8	28	1.35€
S04H3118	18	24,1	25,7	28	1.45€
S04H3119	19	24,1	25,7	28	1.50€
S04H3120	20	25	27,6	32	1.65€
S04H3121	21	25	27,6	32	1.75€
S04H3122	22	27,8	29,6	32	1.85€
S04H3124	24	29,8	31	32	1.95€



S04HD31

Chave de caixa sextavada longa 3/8"

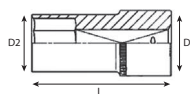

Ref.	Medida (mm)	D1 (mm)	D2 (mm)	L (mm)	Preço
S04HD3109	9	16,8	13,3	63	1.85€
S04HD3110	10	17	14,4	63	1.85€
S04HD3111	11	17	15,8	63	1.90€
S04HD3112	12	17	17,7	63	1.95€
S04HD3113	13	18	19	63	2.00€
S04HD3114	14	18,8	19,7	63	2.05€
S04HD3115	15	19,8	20,8	63	2.15€
S04HD3116	16	20,8	22	63	2.20€
S04HD3117	17	22,8	23,8	63	2.25€
S04HD3119	19	23,8	26	63	2.55€
S04HD3120	20	24,8	27,8	63	3.00€
S04HD3121	21	25,8	28	63	3.05€
S04HD3124	24	28	24	63	3.20€

S04H41

Chave de caixa sextavada 1/2"

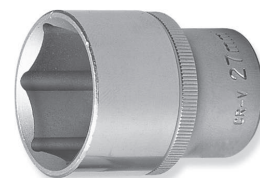
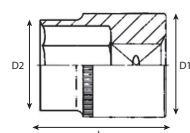

Ref.	Medida (mm)	D1 (mm)	D2 (mm)	L (mm)	Preço
S04H4108	8	21,8	13,8	38	1.35€
S04H4109	9	21,8	14,3	38	1.35€
S04H4110	10	21,8	15,4	38	1.35€
S04H4111	11	21,8	16,7	38	1.40€
S04H4112	12	21,8	18	38	1.40€
S04H4113	13	21,8	19	38	1.40€
S04H4114	14	22	20,3	38	1.45€
S04H4115	15	22	21,3	38	1.50€
S04H4116	16	22	23,3	38	1.55€
S04H4117	17	23	23,8	38	1.60€
S04H4118	18	23,5	24,8	38	1.65€
S04H4119	19	24	27	38	1.75€
S04H4120	20	24	28	38	2.05€
S04H4121	21	24	29	38	2.15€
S04H4122	22	28	30	38	2.25€
S04H4123	23	28	30,7	38	2.45€
S04H4124	24	28	31,8	38	2.55€
S04H4125	25	28	33,8	38	2.85€
S04H4126	26	30	34	42	2.95€
S04H4127	27	28	35,7	42	3.05€
S04H4128	28	30	38	42	3.25€
S04H4129	29	32	38	42	3.55€
S04H4130	30	34	39,8	42	3.65€
S04H4132	32	36	42	42	3.95€
S04H4134	34	40	45	48	5.20€
S04H4136	36	41	48	48	6.50€

S04HD41

Chave de caixa sextavada longa 1/2"

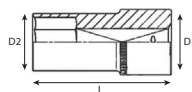

Ref.	Medida (mm)	D1 (mm)	D2 (mm)	L (mm)	Preço
S04HD4109	12	21,8	12,7	76	2.95€
S04HD4110	10	21,8	15,4	76	3.00€
S04HD4111	11	21,8	16,7	76	3.05€
S04HD4112	12	21,8	18	76	3.05€
S04HD4113	13	21,8	19	76	3.10€
S04HD4114	14	22	20,3	76	3.15€
S04HD4115	15	22	21,3	76	3.25€
S04HD4116	16	22	23	76	3.30€
S04HD4117	17	23	23,8	76	3.35€
S04HD4118	18	23	24,8	76	3.45€
S04HD4119	19	24	25,8	76	3.50€
S04HD4120	20	24	28	76	3.55€
S04HD4121	21	24	29	76	3.60€
S04HD4122	22	26	30	76	3.75€
S04HD4123	23	28	31,8	76	3.85€
S04HD4124	24	28	31,8	76	3.95€
S04HD4125	25	28	33,8	76	5.30€
S04HD4126	26	28	33,8	76	5.60€
S04HD4127	27	28	35,7	76	6.10€
S04HD4128	28	30	38	76	6.30€
S04HD4130	30	34	39,8	76	7.15€
S04HD4132	32	36	42	76	7.35€



S04HD4115

40.50€

Jogo de 10 chaves de caixa longas de 1/2" - 6 faces

Composição:

S04HD4 Chaves: 10; 11; 13; 14; 15; 17; 19; 21; 22 e 24mm



S04H61

Chave de caixa sextavada 3/4"

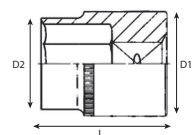

Ref.	Medida (mm)	D1 (mm)	D2 (mm)	L (mm)	Preço
S04H6119	19	30	36	49,5	4.85€
S04H6121	21	32	36	49,5	4.90€
S04H6122	22	33	36	49,5	4.90€
S04H6124	24	35	36	49,5	4.95€
S04H6127	27	38	36	52	4.95€
S04H6128	28	39	36	52	5.00€
S04H6130	30	42	38	54	5.80€
S04H6132	32	44	38	56	6.10€
S04H6134	34	46	38	58	7.00€
S04H6136	36	50	42	58	7.60€
S04H6138	38	52	45	60	8.00€
S04H6141	41	56	45	64	8.80€
S04H6146	46	62	48	68	10.70€
S04H6150	50	68	48	72	11.80€
S04H6152	52	69	48	73	17.00€

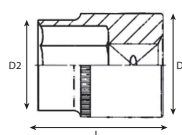

S04H63
Chave de caixa 3/4" - 12 faces

Ref.	Medida (mm)	D1 (mm)	D2 (mm)	L (mm)	Preço
S04H6319	19	30	36	49,5	4.80€
S04H6321	21	32	36	49,5	4.90€
S04H6322	22	33	36	49,5	4.95€
S04H6323	23	34	36	49,5	5.00€
S04H6324	24	35	36	49,5	5.10€
S04H6325	25	37	36	50	5.60€
S04H6326	26	37	36	50	5.70€
S04H6327	27	38	36	52	5.90€
S04H6329	29	40	38	53	6.00€
S04H6330	30	42	38	54	6.40€
S04H6332	32	44	38	56	6.60€
S04H6334	34	46	38	58	7.00€
S04H6336	36	50	42	58	7.70€
S04H6338	38	52	45	60	8.10€
S04H6341	41	56	45	64	9.50€
S04H6346	46	62	48	68	11.20€
S04H6350	50	68	48	72	12.90€
S04H6355	55	74	48	76	17.40€
S04H6356	56	75	48	76	17.50€
S04H6360	60	70	48	78	19.60€
S04H6365	65	87	60	85	26.00€

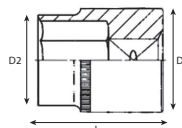

S04H64
Chave de caixa 3/4" - 12 faces (em polegadas)

Ref.	Medida	D1 (mm)	D2 (mm)	L (mm)	Preço
S04H6419	3/4"	30	36	49,5	5.50€
S04H6421	13/16"	32	36	49,5	5.50€
S04H6422	7/8"	33	36	49,5	5.50€
S04H6424	15/16"	34	36	49,5	5.55€
S04H6426	1"	35	36	49,5	5.60€
S04H6427	1-1/16"	38	36	52	5.70€
S04H6429	1-1/8"	40	38	53	6.00€
S04H6430	1-3/16"	42	38	54	6.05€
S04H6432	1-1/4"	44	38	56	6.10€
S04H6433	1-5/16"	46	38	56	6.20€
S04H6435	1-3/8"	48	42	58	7.30€
S04H6436	1-7/16"	50	42	58	7.40€
S04H6438	1-1/2"	52	45	60	8.10€
S04H6440	1-9/16"	52	45	60	8.90€
S04H6441	1-5/8"	56	45	64	8.90€
S04H6443	1-11/16"	56	45	64	9.50€
S04H6444	1-3/4"	56	45	64	9.80€
S04H6446	1-13/16"	62	48	68	10.30€
S04H6447	1-7/8"	62	48	68	13.00€
S04H6450	2"	68	48	72	13.10€
S04H6456	2/14"	75	48	76	17.50€

S04H83

Chave de caixa 1" - 12 faces

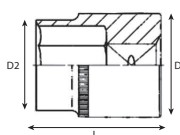
Ref.	Medida (mm)	D1 (mm)	D2 (mm)	L (mm)	Preço
S04H8355	55	76	57	80	23.30€
S04H8360	60	82	57	84	28.50€
S04H8365	65	88	57	87	33.00€



S05H4113S

29.80€

Jogo de 13 chaves de caixa de 1/2" - 12 faces

Composição:

S05H4 Chaves: 10; 12; 13; 14; 15; 16; 17; 18; 19; 20; 21; 22 e 24mm



S05H4213S

37.50€

Jogo de 13 chaves de caixa de 1/2" SAE

Composição:

Chaves: 3/8"; 7/16"; 1/2"; 9/16"; 5/8"; 11/16"; 3/4"; 13/16"; 7/8"; 15/16"; 1"; 1-1/16" e 1-1/8"



S05HD41

Chave de caixa sextavada longa 1/2"

Ref.	Medida (mm)	D1 (mm)	D2 (mm)	L (mm)	Preço
S05HD4110	10	21,8	15,4	76	3.00€
S05HD4111	11	21,8	16,7	76	3.05€
S05HD4112	12	21,8	18	76	3.10€
S05HD4113	13	21,8	19	76	3.15€
S05HD4117	17	23,8	23,8	76	3.30€
S05HD4118	18	24,8	16,7	76	3.40€
S05HD4119	19	25,8	25,8	76	3.60€
S05HD4120	20	27,9	27,9	76	3.70€
S05HD4121	21	27,9	27,9	76	3.80€
S05HD4122	22	30	30	76	3.90€
S05HD4123	23	31,8	31,8	76	4.50€
S05HD4124	24	31,8	31,8	76	5.40€
S05HD4127	27	36	36	76	6.20€
S05HD4130	30	40	40	76	6.95€
S05HD4132	32	42	42	76	7.35€

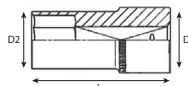

S05HD4113S

59.00€

Jogo de 13 chaves de caixa longas 1/2" - 6 faces

Composição:

S05HD4 Chaves: 11; 13; 14; 15; 17; 19; 21; 22; 23; 24; 27; 30 e 32mm



S06H37S



14.90€

Jogo de 7 chaves de caixa para parafusos torx 3/8"

Composição:

S06H3 Chaves: E10; E11; E12; E14; E16; E18 e E20



S05HD4213S

48.50€

Jogo de 13 chaves de caixa longas 1/2" SAE

Composição:

Chaves: 7/16"; 1/2"; 9/16"; 5/8"; 11/16"; 3/4"; 13/16"; 7/8"; 15/16"; 1"; 1-1/16"; 1-1/8" e 1-1/4"



S06H49S



23.50€

Jogo de 9 chaves de caixa para parafusos torx 1/2"

Composição:

S06H4 Chaves: E10; E11; E12; E14; E16; E18; E20; E22 e E24



S66H41

Chaves de caixa de 1/2" - 12 faces

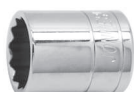

Ref.	Medida (mm)	Preço
S66H4108	8	1.35€
S66H4110	10	1.45€
S66H4111	11	1.50€
S66H4112	12	1.50€
S66H4113	13	1.55€
S66H4114	14	1.55€
S66H4115	15	1.55€
S66H4116	16	1.60€
S66H4117	17	1.60€
S66H4118	18	1.75€
S66H4119	19	1.75€
S66H4120	20	1.95€
S66H4121	21	2.25€
S66H4122	22	2.55€
S66H4124	24	3.20€
S66H4125	25	3.55€
S66H4126	26	3.80€
S66H4127	27	4.00€
S66H4128	28	4.20€
S66H4130	30	4.60€
S66H4132	32	5.60€
S66H4136	36	7.45€

S66HD41

Chaves de caixa longas de 1/2" - 12 faces



Ref.	Medida (mm)	Preço
S66HD4110	10	2.35€
S66HD4111	11	2.35€
S66HD4112	12	2.40€
S66HD4113	13	2.40€
S66HD4114	14	2.45€
S66HD4115	15	2.55€
S66HD4116	16	2.55€
S66HD4117	17	2.60€
S66HD4118	18	2.65€
S66HD4119	19	2.75€
S66HD4120	20	2.90€
S66HD4121	21	2.95€
S66HD4122	22	3.35€
S66HD4123	23	3.45€
S66HD4124	24	3.55€
S66HD4127	27	4.60€
S66HD4130	30	5.60€
S66HD4132	32	6.10€



PHILLIPS	FENDA	TORX	TORX TEMP.	HEXAGONAL	XZN
----------	-------	------	------------	-----------	-----

S06H2



Chave de caixa torx 1/4"

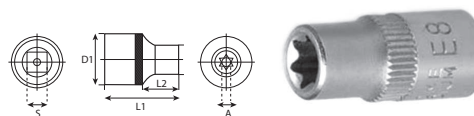

Ref.	Medida	D1 (mm)	D2 (mm)	L1 (mm)	L2 (mm)	Preço
S06H204	E4	12	6,2	25	11	1.05€
S06H205	E5	12	7,2	25	11	1.05€
S06H206	E6	12	8,2	25	11	1.05€
S06H207	E7	12	9	25	11	1.10€
S06H208	E8	12	10,3	25	11	1.10€
S06H210	E10					1.15€
S06H211	E11					1.15€

S06H3



Chave de caixa torx 3/8"



Ref.	Medida	D1 (mm)	D2 (mm)	L1 (mm)	Preço
S06H306	E6	17	11,2	28	1.50€
S06H307	E7	17	11,2	28	1.50€
S06H308	E8	17	11,2	28	1.50€
S06H310	E10	17	13,2	28	1.50€
S06H311	E11	17	13,8	28	1.50€
S06H312	E12	17	14,8	28	1.50€
S06H314	E14	18	16,8	28	1.50€
S06H316	E16	20	18,8	28	1.50€
S06H318	E18	22	20,8	28	1.50€
S06H320	E20	24	22,8	28	1.70€

S06H4



Chave de caixa torx 1/2"



Ref.	Medida	D1 (mm)	D2 (mm)	L1 (mm)	L2 (mm)	Preço
S06H410	E10	22	13,2	38	17	2.05€
S06H411	E11	22	13,9	38	17	2.05€
S06H412	E12	22	15	38	17	2.10€
S06H414	E14	22	16,7	38	17	2.15€
S06H416	E16	22	18,8	38	17	2.15€
S06H418	E18	22	20,8	38	17	2.15€
S06H420	E20	22	23	38	17	2.20€
S06H422	E22	22	25	38	17	2.20€
S06H424	E24	22	27	38	17	2.55€



S07H2

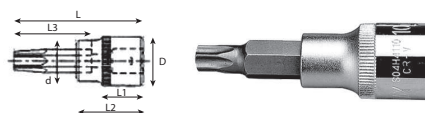

Chave de caixa bit torx 1/4" - 37mm



Ref.	Medida	L1 (mm)	L2 (mm)	L3 (mm)	L (mm)	D (mm)	d (mm)	Preço
S07H206	T6	13	19	25	37	12	10,8	1.05€
S07H207	T7	13	19	25	37	12	10,8	1.05€
S07H208	T8	13	19	25	37	12	10,8	1.05€
S07H209	T9	13	19	25	37	12	10,8	1.05€
S07H210	T10	13	19	25	37	12	10,8	1.05€
S07H215	T15	13	19	25	37	12	10,8	1.05€
S07H220	T20	13	19	25	37	12	10,8	1.05€
S07H225	T25	13	19	25	37	12	10,8	1.05€
S07H227	T27	13	19	25	37	12	10,8	1.05€
S07H230	T30	13	19	25	37	12	10,8	1.05€
S07H240	T40	13	19	25	37	12	10,8	1.05€

S07H3

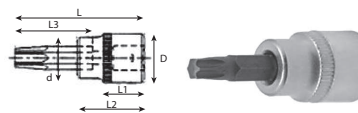
Chave de caixa bit torx 3/8" - 48mm



Ref.	Medida	L1 (mm)	L2 (mm)	L3 (mm)	L (mm)	D (mm)	d (mm)	Preço
S07H310	T10	16,5	26	30	48	18	13,8	1.15€
S07H315	T15	16,5	26	30	48	18	13,8	1.15€
S07H320	T20	16,5	26	30	48	18	13,8	1.15€
S07H325	T25	16,5	26	30	48	18	13,8	1.15€
S07H327	T27	16,5	26	30	48	18	13,8	1.15€
S07H330	T30	16,5	26	30	48	18	13,8	1.15€
S07H340	T40	16,5	26	30	48	18	13,8	1.15€
S07H345	T45	16,5	26	30	48	18	15,8	1.35€
S07H350	T50	16,5	26	30	48	18	15,8	1.35€
S07H355	T55	16,5	26	30	48	18	16,1	1.45€
S07H360	T60	16,5	26	30	48	18	16,1	1.55€

S07H4

Chave de caixa bit torx 1/2" - 55mm



Ref.	Medida	L1 (mm)	L2 (mm)	L3 (mm)	L (mm)	D (mm)	d (mm)	Preço
S07H420	T20	20	38	30	55	22	15	2.15€
S07H425	T25	20	38	30	55	22	15	2.15€
S07H427	T27	20	38	30	55	22	15	2.15€
S07H430	T30	20	38	30	55	22	15	2.15€
S07H440	T40	20	38	30	55	22	15	2.15€
S07H445	T45	20	38	30	55	22	15	2.15€
S07H450	T50	20	38	30	55	22	15	2.25€
S07H455	T55	20	38	30	55	22	17	2.35€
S07H460	T60	20	38	30	55	24	22	2.45€
S07H470	T70	20	38	30	55	24	22	2.55€

S07H43

Chave de caixa bit torx 1/2" - 100mm



Ref.	Medida	L1 (mm)	L2 (mm)	L3 (mm)	L (mm)	D (mm)	d (mm)	Preço
S07H4320	T20	20	38	75	100	24	15	3.05€
S07H4325	T25	20	38	75	100	24	15	3.05€
S07H4327	T27	20	38	75	100	24	15	3.05€
S07H4330	T30	20	38	75	100	24	15	3.15€
S07H4340	T40	20	38	75	100	24	15	3.15€
S07H4345	T45	20	38	75	100	24	15	3.15€
S07H4350	T50	20	38	75	100	24	15	3.15€
S07H4352	T52	20	38	75	100	24	15	3.25€
S07H4355	T55	20	38	75	100	24	17	3.25€
S07H4360	T60	20	38	75	100	24	22	3.45€
S07H4370	T70	20	38	75	100	24	22	3.55€

S07H45

Chave de caixa bit torx de 1/2"



Ref.	Medida	Comp. (mm)	Preço
S07H4530	T30	200	5.10€
S07H4540	T40	200	5.10€
S07H4545	T45	200	5.10€

S08H311S

Jogo de 11 bits de 1/4" e 3/8" torx tamperproof

12.50€



Composição:

Chaves de 1/4": T8; T10; T15; T20; T25 e T27

Chaves de 3/8": T30; T40; T45; T50 e T55

S09H2

Chave de caixa bit hexagonal 1/4" - 37mm

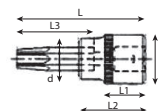

Ref.	Medida	L1 (mm)	L2 (mm)	L3 (mm)	L (mm)	D (mm)	d (mm)	Preço
S09H203	H3	13	19	25	37	12	10,8	1.05€
S09H204	H4	13	19	25	37	12	10,8	1.05€
S09H205	H5	13	19	25	37	12	10,8	1.05€
S09H206	H6	13	19	25	37	12	10,8	1.05€
S09H207	H7	13	19	25	37	12	10,8	1.05€

S09H3

Chave de caixa bit hexagonal 3/8" - 48mm



Ref.	Medida	L1 (mm)	L2 (mm)	L3 (mm)	L (mm)	D (mm)	d (mm)	Preço
S09H303	H3	16,5	26	30	48	18	13,8	1.25€
S09H304	H4	16,5	26	30	48	18	13,8	1.25€
S09H305	H5	16,5	26	30	48	18	13,8	1.25€
S09H306	H6	16,5	26	30	48	18	13,8	1.25€
S09H307	H7	16,5	26	30	48	18	15,8	1.25€
S09H308	H8	16,5	26	30	48	18	15,8	1.35€
S09H310	H10	16,5	26	30	48	18	16,1	1.35€
S09H312	H12	16,5	26	30	48	18	16,1	1.55€
S09H314	H14	16,5	26	30	48	18	16,1	1.75€



S09H4

Chave de caixa bit hexagonal 1/2" - 55mm



Ref.	Medida	L1 (mm)	L2 (mm)	L3 (mm)	L (mm)	D (mm)	d (mm)	Preço
S09H404	H4	20	38	30	55	24	15	2.25€
S09H405	H5	20	38	30	55	24	15	2.25€
S09H406	H6	20	38	30	55	24	15	2.25€
S09H407	H7	20	38	30	55	24	15	2.25€
S09H408	H8	20	38	30	55	24	15	2.25€
S09H410	H10	20	38	30	55	24	17,8	2.35€
S09H412	H12	20	38	30	55	24	22	2.55€
S09H414	H14	20	38	30	55	24	22	2.55€
S09H416	H16	20	38	30	55	24	22	2.75€
S09H417	H17	20	38	30	55	24	22	3.25€
S09H419	H19	20	38	30	55	24	22	3.65€

S09H43



Chave de caixa bit hexagonal 1/2" - 100mm



Ref.	Medida	L1 (mm)	L2 (mm)	L3 (mm)	L (mm)	D (mm)	d (mm)	Preço
S09H4304	H4	20	38	75	100	24	15	3.05€
S09H4305	H5	20	38	75	100	24	15	3.05€
S09H4306	H6	20	38	75	100	24	15	3.10€
S09H4307	H7	20	38	75	100	24	15	3.10€
S09H4308	H8	20	38	75	100	24	15	3.10€
S09H4309	H9	20	38	75	100	24	15	3.15€
S09H4310	H10	20	38	75	100	24	20,8	3.25€
S09H4312	H12	20	38	75	100	24	22	3.45€
S09H4314	H14	20	38	75	100	24	22	3.50€
S09H4316	H16	20	38	75	100	24	22	4.10€
S09H4317	H17	20	38	75	100	24	22	4.70€
S09H4319	H19	20	38	75	100	24	22	6.35€

S10H2

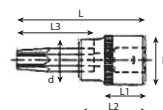
Chave de caixa bit fenda 1/4" - 37mm



Ref.	Medida (mm)	L1 (mm)	L2 (mm)	L3 (mm)	L (mm)	D (mm)	d (mm)	Preço
S10H230	3	13	21	25	37	12	10,8	1.05€
S10H235	3,5	13	21	25	37	12	10,8	1.05€
S10H240	4	13	21	25	37	12	10,8	1.05€
S10H245	4,5	13	21	25	37	12	10,8	1.05€
S10H250	5	13	21	25	37	12	10,8	1.05€
S10H255	5,5	13	21	25	37	12	10,8	1.05€
S10H260	6	13	21	25	37	12	10,8	1.05€
S10H270	7	13	21	25	37	12	10,8	1.05€

S10H3



Chave de caixa bit fenda 3/8" - 48mm



Ref.	Medida (mm)	L1 (mm)	L2 (mm)	L3 (mm)	L (mm)	D (mm)	d (mm)	Preço
S10H340	4	15,5	26,5	30	48	18	13,8	1.05€
S10H350	5	15,5	26,5	30	48	18	13,8	1.05€
S10H355	5,5	15,5	26,5	30	48	18	13,8	1.10€
S10H360	6	15,5	26,5	30	48	18	13,8	1.10€
S10H370	7	15,5	26,5	30	48	18	13,8	1.15€
S10H380	8	15,5	26,5	30	48	18	15,8	1.15€
S10H3100	10	15,5	26,5	30	48	20	17,8	1.35€
S10H3120	12	15,5	26,5	30	48	20	17,8	1.55€



S10H4



Chave de caixa bit fenda 1/2" - 55mm



Ref.	Medida (mm)	L1 (mm)	L2 (mm)	L3 (mm)	L (mm)	D (mm)	d (mm)	Preço
S10H480	8	20	36	30	55	22	17,8	2.15€
S10H490	9	20	36	30	55	22	17,8	2.35€
S10H4100	10	20	36	30	55	22	17,8	2.35€
S10H4110	11	20	36	30	55	24	20,8	2.45€
S10H4120	12	20	36	30	55	24	20,8	2.50€

S11H2



Chave de caixa bit phillips 1/4" - 37mm



Ref.	Medida	L1 (mm)	L2 (mm)	L3 (mm)	L (mm)	D (mm)	d (mm)	Preço
S11H200	PH0	13	19	25	37	12	10,8	1.05€
S11H201	PH1	13	19	25	37	12	10,8	1.05€
S11H202	PH2	13	19	25	37	12	10,8	1.05€
S11H203	PH3	13	19	25	37	12	10,8	1.05€

S11H3



Chave de caixa bit phillips 3/8" - 48mm

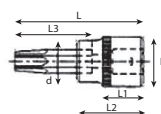

Ref.	Medida	L1 (mm)	L2 (mm)	L3 (mm)	L (mm)	D (mm)	d (mm)	Preço
S11H300	PH0	16,5	26	30	48	18	13,8	1.15€
S11H301	PH1	16,5	26	30	48	18	13,8	1.15€
S11H302	PH2	16,5	26	30	48	18	13,8	1.20€
S11H303	PH3	16,5	26	30	48	18	15,8	1.20€
S11H304	PH4	16,5	26	30	48	18	15,8	1.35€

S11H4



Chave de caixa bit phillips 1/2" - 55mm



Ref.	Medida	L1 (mm)	L2 (mm)	L3 (mm)	L (mm)	D (mm)	d (mm)	Preço
S11H402	PH2	55	38	30	55	24	15	2.15€
S11H403	PH3	55	38	30	55	24	15	2.15€
S11H404	PH4	55	38	30	55	24	15	2.15€



S49H4

Chave de caixa bits estriado XZN de 1/2"

Ref.	Medida	Comp. (mm)	Preço
S49H4105	M5	55	2.85€
S49H4106	M6	55	2.85€
S49H4108	M8	55	2.90€
S49H4110	M10	55	2.90€
S49H4112	M12	55	3.05€
S49H4114	M14	55	3.45€
S49H4116	M16	55	5.10€
S49H4308	M8	100	4.20€
S49H4310	M10	100	4.30€
S49H4312	M12	100	4.35€
S49H4314	M14	100	5.40€
S49H4318	M18	100	8.00€

S50H3106S

10.80€

Jogo de 6 bits hexagonais 3/8"

Composição:

Chaves: 4; 5; 6; 7; 8 e 10 mm

S50H3206S

10.90€

Jogo de 6 bits hexagonais 3/8" SAE

Composição:

Chaves: 5/32"; 3/16"; 7/32"; 1/4"; 5/16" e 3/8"

S54H5509S

13.20€

Jogo de 9 chaves de torx de 1/4" e 3/8"

Composição:

S54H2 Chaves de 1/4": T10; T15; T20 e T25

S54H3 Chaves de 3/8": T25; T30; T40; T45 e T50

S63H33

Chave de caixa Ribe 3/8" - 90mm

Ref.	Medida	Comp. (mm)	Preço
S63H3306	M6	90	1.45€
S63H3307	M7	90	1.75€
S63H3308	M8	90	1.95€
S63H3310	M10	90	2.55€

Ferramenta de aperto
S63H43

Chave de caixa Ribe 1/2" - 100mm

Ref.	Medida	Comp. (mm)	Preço
S63H4306	M6	100	2.95€
S63H4307	M7	100	3.05€
S63H4308	M8	100	3.15€
S63H4310	M10	100	3.25€
S63H4312	M12	100	3.35€
S63H4313	M13	100	3.45€

S63H44

Chave de caixa Ribe 1/2" - 55mm

Ref.	Medida	Comp. (mm)	Preço
S63H4405	M5	55	2.45€
S63H4406	M6	55	2.55€
S63H4407	M7	55	2.65€
S63H4408	M8	55	2.75€
S63H4409	M9	55	2.85€
S63H4410	M10	55	2.95€
S63H4412	M12	55	3.25€
S63H4413	M13	55	3.75€
S63H4414	M14	55	4.35€

S63H4507S

19.50€

Jogo de 7 bits longos 6 caneluras (Ribe) 3/8" e 1/2"

Composição:

Bits 3/8" de 90 mm: M6; M7; M8 e M10

Bits 1/2" de 100 mm: M12; M13 e M14

S63H46

Chave de caixa Ribe 1/2" - 100mm

Ref.	Medida	Comp. (mm)	Preço
S63H4605	M5	100	2.95€
S63H4606	M6	100	3.00€
S63H4607	M7	100	3.05€
S63H4608	M8	100	3.10€
S63H4609	M9	100	3.25€
S63H4610	M10	100	3.30€
S63H4612	M12	100	3.65€
S63H4613	M13	100	4.70€
S63H4614	M14	100	4.90€



Ferramenta de aperto

S63H47



Chave de caixa Ribe 1/2" - 140mm

Ref.	Medida	Comp. (mm)	Preço
S63H4708	M8	140	3.50€
S63H4709	M9	140	3.50€
S63H4710	M10	140	3.55€
S63H4712	M12	140	4.20€
S63H4713	M13	140	5.00€
S63H4714	M14	140	5.10€

S63H48



Chave de caixa Ribe 1/2" - 200mm

Ref.	Medida	Comp. (mm)	Preço
S63H4808	M8	200	4.30€
S63H4809	M9	200	4.40€
S63H4810	M10	200	4.50€
S63H4812	M12	200	5.40€
S63H4813	M13	200	6.45€
S63H4814	M14	200	6.55€

C-DMH



Barra magnética para chaves de caixa

Ref.	Medida	Capacid. (chaves)	Preço
C-DMH212	1/4"	12	14.50€
C-DMH314	3/8"	14	22.30€
C-DMH414	1/2"	12	23.70€

MSH



Régua suporte para chaves de caixa

Ref.	Medida	Capacid. (chaves)	Preço
MSH1214	1/2"	14	2.00€
MSH1414	1/4"	14	1.70€
MSH3814	3/8"	14	1.90€

S15H

Cardan

Ref.	Medida	D1 (mm)	D2 (mm)	L (mm)	Acabamento	Preço
S15H240	1/4"	14	14	35	Mate	2.35€
S15H356	3/8"	18	18	49	Mate	3.65€
S15H472	1/2"	25	25	69	Mate	4.60€
S15H6109	3/4"	39,7	39,5	106,2	Polido	22.45€



S64H4



Chave de caixa bits estriado XZN de 1/2"

Ref.	Medida	Comp. (mm)	Preço
S64H4104	M4	55	2.30€
S64H4105	M5	55	2.30€
S64H4106	M6	55	2.30€
S64H4107	M7	55	2.30€
S64H4109	M9	55	2.30€
S64H4113	M13	55	3.10€
S64H4204	M4	100	2.90€
S64H4205	M5	100	2.90€
S64H4206	M6	100	2.90€
S64H4207	M7	100	2.90€
S64H4208	M8	100	2.90€
S64H4209	M9	100	2.90€
S64H4210	M10	100	2.90€
S64H4212	M12	100	3.80€
S64H4214	M14	100	4.70€
S64H4216	M16	100	5.20€
S64H4218	M18	100	8.80€
S64H4705	M5	140	3.40€
S64H4706	M6	140	3.40€
S64H4708	M8	140	3.40€
S64H4709	M9	140	3.45€
S64H4710	M10	140	3.50€
S64H4712	M12	140	4.20€
S64H4714	M14	140	5.00€
S64H4808	M8	200	4.20€
S64H4810	M10	200	4.20€
S64H4812	M12	200	5.30€
S64H4814	M14	200	6.20€



S16H
Adaptador

Ref.	Medida	A (mm)	D1 (mm)	D2 (mm)	L (mm)	Acabamento	Preço
S16H1234	1/2" F - 3/4" M	19	12,7	27	45	Polido	3.40€
S16H1238	1/2" F - 3/8" M	9,52	12,7	22	34	Mate	1.25€
S16H1438	1/4" F - 3/8" M	9,52	6,35	14	25	Mate	1.05€
S16H3410	3/4" F - 1" M	25,3	19,05	39,7	59,6	Polido	9.70€
S16H3412	3/4" F - 1/2" M	12,7	19,05	35	51	Polido	5.40€
S16H3812	3/8" F - 1/2" M	12,7	9,52	17	35	Mate	1.25€
S16H3814	3/8" F - 1/4" M	6,35	9,75	18,6	28	Mate	1.05€

S16H
Adaptador

Ref.	Medida	A (mm)	D1 (mm)	D2 (mm)	L (mm)	Acabamento	Preço
S16H302	1/4" M - 3/8" F	6,35	9,75	18,6	28	Mate	2.05€
S16H304	1/2" M - 3/8" F	12,7	9,75	23,5	43,7	Mate	3.05€
S16H403	3/8" M - 1/2" F	9,5	12,9	23,5	40	Mate	3.05€

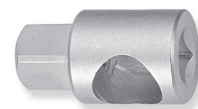
S17H
Chave de velas

Ref.	Medida	A (mm)	D1 (mm)	D2 (mm)	L (mm)	Acabamento	Preço
S17H3116	3/8"	9,525	21,7	18,8	65	Mate	1.55€
S17H3121	3/8"	9,525	27,6	21,5	65	Mate	2.05€
S17H4116	1/2"	12,7	21,8	21,8	65	Mate	1.55€
S17H4121	1/2"	12,7	27,6	23,6	65	Mate	2.15€

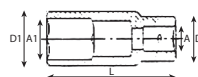
S17H3414
5.00€
Chave de velas 12 faces 3/8"

 Medida: 14mm
 Acabamento: Mate

S21H
Extensão

Ref.	Quadra	Medida (mm)	Acabamento	Preço
S21H4150	1/2"	50	Mate	3.05€
S21H4175	1/2"	75	Mate	3.25€
S21H41125	1/2"	125	Mate	4.30€
S21H41250	1/2"	250	Mate	6.35€

S22H
Cabo articulado

Ref.	Quadra	Medida (mm)	Acabamento	Preço
S22H21130	1/4"	130	Mate	5.00€
S22H31200	3/8"	200	Mate	6.75€
S22H41375	1/2"	375	Mate	13.25€
S22H41450	1/2"	450	Mate	18.00€

S22H
Cabo articulado

Ref.	Quadra	Medida (mm)	Acabamento	Preço
S22H41600	1/2"	600	Polido	22.00€
S22H6500	3/4"	500	Polido	30.00€

S22H41600RK
8.50€
Kit de reparação para cabo articulado S22H41600

S22H6500RK
11.60€
Kit de reparação para cabo articulado S22H6500

S22H21130RK
2.30€
Kit de reparação para cabo articulado S22H21130

S22H41375RK
2.95€
Kit de reparação para cabo articulado S22H41375 e S22H41450

S23H



Cabo "T" corrediço

Ref.	Quadra	Medida (mm)	Acabamento	Preço
S23H21115	1/4"	115	Mate	2.00€
S23H31200	3/8"	200	Mate	4.30€
S23H41250	1/2"	250	Mate	5.40€
S23H41300	1/2"	300	Mate	6.15€
S23H6450	3/4"	450	Polido	17.15€
S23H6500	3/4"	500	Polido	18.50€
S23H8550	1"	550	Polido	37.50€

S24H



Extensões

Ref.	Quadra	Medida (mm)	Acabamento	Preço
S24H250	1/4"	50	Mate	1.10€
S24H375	3/8"	75	Mate	1.60€
S24H450	1/2"	50	Mate	2.30€
S24H475	1/2"	75	Mate	2.70€
S24H2100	1/4"	100	Mate	1.20€
S24H2150	1/4"	150	Mate	1.40€
S24H3150	3/8"	150	Mate	2.30€
S24H3200	3/8"	200	Mate	2.65€
S24H3250	3/8"	250	Mate	3.20€
S24H4125	1/2"	125	Mate	3.30€
S24H4224	1/2"	610	Polido	20.00€
S24H4250	1/2"	250	Mate	4.10€
S24H6100	3/4"	100	Polido	8.15€
S24H6200	3/4"	200	Polido	11.00€
S24H6400	3/4"	400	Polido	19.40€
S24H8200	1"	200	Polido	24.00€

S26H2150

2.50€

Punho de 1/4"



S26H2280

11.60€

Punho 1/4" dupla função fixo/ cardan



AG010184F

5.30€

Chave flexível ponta macho de 1/4"



S27H



Extensões flexíveis

Ref.	Quadra	Medida (mm)	Preço
S27H2	1/4"	145	2.15€
S27H3	3/8"	193	16.60€
S27H4	1/4"	205	16.50€

S40T

Chave em T com ponta flexível



Ref.	Medida (mm)	Preço
S40T108	8	20.00€
S40T110	10	20.00€
S40T112	12	20.00€
S40T113	13	20.00€
S40T114	14	20.00€
S40T117	17	20.00€
S40T119	19	20.00€

S40T109S

132.00€

Jogo de 9 peças "T" flexíveis

Composição/ medidas em mm:
8; 10; 12; 13; 14; 17 e 19
Travessões P/T



S41H41

10.40€

Manivela quadra macho de 1/2"



S42M

Extensões magnéticas



Ref.	Quadra	Medida (mm)	Preço
S42M475	1/2"	75	8.30€
S42M4125	1/2"	125	8.50€
S42M4250	1/2"	250	11.50€



S42M403S

27.00€

Jogo de 3 extensões magnéticas 1/2"

 Composição/ medidas em mm:
75; 125 e 250

S44H2206

0.90€

Porta bits 1/4"

 Quadra de 1/4" para uso em bits com
encabadouro de 1/4"

S44H3110A

2.30€

Porta bits

Quadra: 3/8"

Utilização em bits: 3/8"

S44H3206

1.90€

Porta bits

Quadra: 3/8"

Utilização em bits: 1/4"

S44H4110

1.80€

Porta bits

Quadra: 1/2"

Utilização em bits: 3/8"

S60H4304S

36.50€

Jogo de 4 extensões de 1/2"

 Composição/ medidas em mm:
75; 125; 250 e 375

Ferramenta de aperto
R53A-3

Adaptador "macho/macho"

Para aplicação em conjunto com o cabo "T" flexível R53A

Ref.	Quadra	Compr. (mm)	Preço
R53A-2A	1/4"	20	1.00€
R53A-3A	3/8"	30	1.40€
R53A-4A	1/2"	35	1.90€

R19H3

Chave pata de galo 3/8"

Ref.	Medida (mm)	Preço
R19H3110	10	4.20€
R19H3111	11	4.20€
R19H3112	12	4.20€
R19H3113	13	4.20€
R19H3114	14	4.20€
R19H3115	15	4.20€
R19H3116	16	4.40€
R19H3117	17	4.50€
R19H3118	18	4.60€
R19H3119	19	4.60€

R19H310S

41.40€

Jogo de 10 chaves pata de galo de 3/8"

Composição/ medidas em mm:

Chaves: 10; 11; 12; 13; 14; 15; 16; 17; 18 e 19

S03A4111S

34.50€

Jogo de 11 chaves de impacto de 1/2"

Composição/ medidas (mm):

S03A4 Chaves: 10; 11; 12; 13; 14; 16; 17; 19; 21; 22 e 24

S01U41

Cardan de impacto 1/2"

Ref.	Medida (mm)	Compr. (mm)	Preço
S01U4113	13	70	10.50€
S01U4114	14	70	10.60€
S01U4115	15	70	10.70€
S01U4116	16	70	10.80€
S01U4117	17	70	11.20€
S01U4119	19	70	11.50€
S01U4121	21	70	11.90€
S01U4122	22	70	12.40€



S01U4108S

89.50€

Jogo 8 chaves/ cardans impacto 1/2"

Composição/ medidas em mm:
Chaves: 13; 14; 15; 16;
17; 19; 21 e 22



S03A2

Chave de impacto 1/4"



Ref.	Quadra	Medida (mm)	Preço
S03A2110	1/4"	10	1.45€
S03A2112	1/4"	12	1.55€
S03A2114	1/4"	14	1.65€



S03A4

Chave impacto 1/2"

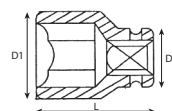

Ref.	Medida (mm)	D1 (mm)	D2 (mm)	L (mm)	Preço
S03A4109	9	15	24	38	2.65€
S03A4110	10	17	24	38	2.65€
S03A4111	11	19	24	38	2.65€
S03A4112	12	20	24	38	2.70€
S03A4113	13	20,8	24	38	2.70€
S03A4114	14	22	24	38	2.75€
S03A4115	15	24	24	38	2.75€
S03A4116	16	24	24	38	2.95€
S03A4117	17	26	26	38	3.15€
S03A4118	18	26	27	38	3.25€
S03A4119	19	28	28	38	3.35€
S03A4121	21	30	30	38	3.45€
S03A4122	22	32	30	38	3.75€
S03A4123	23	34	30	38	4.10€
S03A4124	24	34	30	43	4.20€
S03A4127	27	38	30	43	6.10€
S03A4129	29	40	30	48	6.65€
S03A4130	30	42	30	48	6.70€
S03A4132	32	44,6	30	48	7.15€

S03AD4

Chave impacto longa 1/2"



Ref.	Medida (mm)	D1 (mm)	D2 (mm)	L (mm)	Preço
S03AD4110	10	17	24	78	4.40€
S03AD4111	11	19	24	78	4.45€
S03AD4112	12	19,6	24	78	4.50€
S03AD4113	13	20,8	24	78	4.55€
S03AD4114	14	22	24	78	4.60€
S03AD4115	15	24	24	78	4.60€
S03AD4116	16	24	24	78	4.65€
S03AD4117	17	26	26	78	4.80€
S03AD4118	18	28	27	78	5.00€
S03AD4119	19	28	28	78	5.10€
S03AD4121	21	30	30	78	5.60€
S03AD4122	22	32	30	78	5.90€
S03AD4124	24	34,6	30	78	6.70€
S03AD4126	26	37	30	78	7.90€
S03AD4127	27	38	30	78	8.40€
S03AD4128	28	39,5	30	78	8.60€
S03AD4130	30	42	30	78	10.00€
S03AD4132	32	44,6	30	78	10.70€

S03AD4111S
53.80€
Jogo de 11 chaves de impacto longas de 1/2"

Composição/ medidas (mm):

S03AD4 Chaves: 10; 11; 12; 13; 14; 16; 17; 19; 21; 22 e 24

S03A4A
Adaptador de 1/2"

Ref.	Quadra	Preço
S03A4A3	3/8"	3.90€
S03A4A6	3/4"	5.20€

S03A4U4
10.00€
Cardan de 1/2"

S03A4UT3S
27.90€
Jogo de 3 cardans impacto

Composição/ medidas:

1/4"; 3/8" e 1/2"

S03A
Cardan de impacto

Ref.	Quadra	Preço
S03A2UT	1/4"	7.50€
S03A3UT	3/8"	9.50€
S03A4UT	1/2"	12.00€

S03A4E

Extensão

Ref.	Quadra	Medida (mm)	Preço
S03A4E4	1/2"	100	4.80€
S03A4E5	1/2"	125	4.80€
S03A4E6	1/2"	150	6.10€
S03A4E8	1/2"	200	7.20€

S03A4211S
35.70€
Jogo de 11 chaves impacto 1/2" SAE

Composição:

Ref.	Medida	Ref.	Medida
S03A4210	3/8"	S03AD4219	3/4"
S03A4211	7/16"	S03AD4221	13/16"
S03A4213	1/2"	S03AD4222	7/8"
S03A4214	9/16"	S03AD4224	15/16"
S03A4216	5/8"	S03AD4226	1"
S03A4217	11/16"		



S03AD4414S
82.00€
Jogo de 14 chaves longas impacto 1/2" SAE

Composição/ medidas:

 Chaves: 3/8"; 7/16"; 1/2"; 9/16"; 5/8"; 11/16"; 3/4";
 13/16"; 7/8"; 15/16"; 1"; 1-1/16"; 1-1/8" e 1-1/4"

S03A6

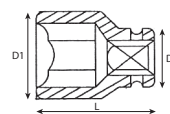
Chave impacto 3/4"



Ref.	Medida (mm)	D1 (mm)	D2 (mm)	L (mm)	Preço
S03A6126	26	41	38	51	6.80€
S03A6127	27	43	40	53	6.90€
S03A6129	29	45	42	53	7.50€
S03A6130	30	46	44	53	7.90€
S03A6132	32	49	44	57	8.50€
S03A6133	33	51	44	57	9.15€
S03A6134	34	51	44	57	9.40€
S03A6135	35	53	44	57	10.10€
S03A6136	36	54	44	57	10.40€
S03A6137	37	55	44	57	10.70€
S03A6138	38	56	44	57	11.00€
S03A6139	39	57,7	44	57	12.15€
S03A6140	40	59	44	57	13.15€
S03A6141	41	60	44	57	13.20€
S03A6142	42	61,4	44	57	15.80€
S03A6143	43	62,7	44	62	16.50€
S03A6144	44	64	44	62	17.80€
S03A6145	45	65	44	62	18.40€
S03A6146	46	66,4	44	62	18.60€
S03A6147	47	67,6	44	67	19.20€
S03A6148	48	68,8	44	67	19.80€
S03A6149	49	70	44	72	20.60€
S03A6150	50	71,4	72	72	22.60€
S03A6151	51	72,8	72	72	25.50€
S03A6152	52	74	72	72	26.40€
S03A6153	53	75	72	72	27.50€
S03A6154	54	76,4	72	72	28.00€
S03A6155	55	77,7	74	74	29.00€
S03A6156	56	79	74	74	31.10€
S03A6157	57	80	74	74	33.00€
S03A6158	58	81,5	75	75	33.10€
S03A6159	59	82,7	75	75	37.20€
S03A6160	60	84	75	75	39.80€
S03A6163	63	87,6	75	75	41.80€
S03A6165	65	90	78	78	44.30€
S03A6167	67	92,7	80	80	48.90€
S03A6170	70	96,4	83	83	56.00€

S03A6108S

67.50€

Jogo de 8 chaves de impacto de 3/4"

Composição/ medidas:

S03A6 Chaves: 26; 27; 29; 30; 32; 35; 36 e 38



S03AD6
Chave impacto longa 3/4"

Ref.	Medida (mm)	D1 (mm)	D2 (mm)	L (mm)	Preço
S03AD6124	24	38,9	44	90	13.50€
S03AD6126	26	41,3	44	90	15.00€
S03AD6127	27	42,6	44	90	15.05€
S03AD6129	29	45,1	44	90	15.30€
S03AD6130	30	46,4	44	90	15.35€
S03AD6132	32	48,9	44	90	15.70€
S03AD6133	33	50,6	44	90	15.75€
S03AD6134	34	51,4	44	90	16.50€
S03AD6135	35	52,7	44	90	16.80€
S03AD6136	36	53,9	44	90	17.60€
S03AD6138	38	56,4	44	90	18.90€
S03AD6140	40	58,9	44	90	22.50€
S03AD6141	41	60,1	44	90	23.60€
S03AD6142	42	61,4	44	90	25.40€
S03AD6144	44				27.50€
S03AD6146	46	66,4	44	90	30.40€
S03AD6150	50	71,4	54	90	34.00€

S03AD6107S
109.00€
Jogo de 7 chaves de impacto longas de 3/4"

Composição/ medidas:

S03AD6 Chaves: 26; 27; 29;
32; 35; 36 e 38

S03AD6120S
248.00€
Jogo de 20 peças de impacto de 3/4"

Composição/ medidas em mm:

S03AD6 Chaves: 24; 27; 30; 32; 33; 34; 35; 36; 41 e 46

S03A6A4 Adaptador 3/4" - 1/2"

S03A6A8 Adaptador 3/4" - 1"

S03A6U6 Cardan 3/4

S03A6E Extensão de 3/4" 250 mm

Pinos

O'ings

S03A6A
Adaptador de 3/4"

Ref.	Quadra	Preço
S03A6A4	1/2"	9.80€
S03A6A8	1"	11.90€

S03A6U6
33.00€
Cardan de 3/4"

S03A6E
Extensão

Ref.	Quadra	Medida (mm)	Preço
S03A6E04	3/4"	100	16.50€
S03A6E08	3/4"	200	21.00€
S03A6E10	3/4"	250	23.50€



S03A8

Chave impacto 1"

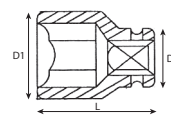

Ref.	Medida (mm)	D1 (mm)	D2 (mm)	L (mm)	Preço
S03A8124	24	41,9	54	58	16.30€
S03A8127	27	45,6	54	58	16.35€
S03A8129	29	48,1	54	60	16.50€
S03A8130	30	49,4	54	60	16.55€
S03A8132	32	51,9	54	60	16.60€
S03A8133	33	53,6	54	60	16.80€
S03A8134	34	54,4	54	62	17.30€
S03A8135	35	55,7	54	62	17.80€
S03A8136	36	56,9	54	62	17.85€
S03A8138	38	59,4	54	65	18.30€
S03A8140	40	110	54	65	19.10€
S03A8141	41	63,1	54	65	19.40€
S03A8144	44	120	54	65	23.40€
S03A8146	46	69,4	54	74	24.50€
S03A8150	50	74,4	54	74	30.10€
S03A8155	55	80,7	54	85	36.70€
S03A8160	60	87,1	54	90	47.50€
S03A8165	65	93,2	54	90	56.00€
S03A8170	70	99,4	54	100	71.00€
S03A8173	73	103,3	86	100	83.00€
S03A8175	75	105,6	86	100	93.00€
S03A8176	76	106,9	86	100	104.00€
S03A8178	78	110	86	100	109.00€
S03A8180	80	111,9	86	100	115.50€
S03A8185	85	118,5	86	110	139.50€
S03A8189	89	123,2	86	110	142.50€
S03A8190	90	124,4	86	110	160.00€
S03A8192	92	126,8	86	110	167.00€
S03A8195	95	129	86	110	185.00€



S03A8109S

170.00€

Jogo de 9 chaves impacto 1"

Composição/ medidas:

S03A8 Chaves: 24; 27; 30; 32; 35; 38; 41; 46 e 50



S03A8A6

16.50€

Adaptador 1" - 3/4"



S03A8E

Extensão impacto



Ref.	Quadra	Medida (mm)	Preço
S03A8E04	1"	100	25.00€
S03A8E07	1"	175	31.00€
S03A8E10	1"	250	46.00€

S03AD8107S

163.00€

Jogo de 7 chaves longas de impacto 1"

Composição/ medidas:

S03AD8 Chaves: H5, H6, H8, H10, H12, H14, H17 e H19
Mala metálica



S03AD8
Chave impacto longa 1"



Ref.	Medida (mm)	D1 (mm)	D2 (mm)	L (mm)	Preço
S03AD8117	17	33,1	54	90	21.30€
S03AD8124	24	41,9	54	90	21.80€
S03AD8126	26	43,3	54	90	21.90€
S03AD8127	27	45,6	54	90	22.00€
S03AD8129	29	48,1	54	90	22.10€
S03AD8130	30	49,4	54	90	22.30€
S03AD8132	32	51,9	54	90	22.60€
S03AD8133	33	53,6	54	90	22.80€
S03AD8134	34	54,4	54	90	23.00€
S03AD8135	35	55,7	54	90	23.50€
S03AD8136	36	56,9	54	90	24.00€
S03AD8138	38	59,4	54	90	26.00€
S03AD8140	40	61,9	54	90	27.50€
S03AD8141	41	63,1	54	90	28.20€
S03AD8142	42	64,4	54	90	29.10€
S03AD8146	46	69,4	54	90	35.00€
S03AD8148	48	71,8	54	90	37.50€
S03AD8150	50	74,4	54	90	43.00€
S03AD8155	55	80,7	54	90	53.50€
S03AD8158	58	84,5	54	105	58.50€
S03AD8160	60	87,1	54	120	67.50€
S03AD8165	65	93,2	54	120	75.00€

S03S8
Chave de impacto quadrada

Ref.	Quadra	Medida (mm)	Preço
S03S8117	1"	17	15.00€
S03S8119	1"	19	16.00€
S03S8121	1"	21	16.50€

S03SD8
Chave de impacto longa quadrada

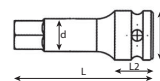
Ref.	Quadra	Medida (mm)	Preço
S03SD8117	1"	17	20.50€
S03SD8119	1"	19	21.00€
S03SD8121	1"	21	21.50€

S05A4H
Bit hexagonal de impacto 1/2"

Ref.	Medida	D (mm)	d (mm)	L2 (mm)	L (mm)	Preço
S05A4H4	H4	25	6	22,5	78	7.90€
S05A4H5	H5	25	7	22,5	78	8.00€
S05A4H6	H6	25	8	22,5	78	8.10€
S05A4H7	H7	25	9	22,5	78	8.10€
S05A4H8	H8	25	10,5	22,5	78	8.15€
S05A4H10	H10	25	12,5	22,5	78	8.60€
S05A4H12	H12	25	15	22,5	78	8.60€
S05A4H14	H14	25	17,5	22,5	78	8.60€
S05A4H17	H17	25	21	22,5	78	8.60€
S05A4H18	H18	25	22	22,5	78	8.60€
S05A4H19	H19	25	23	22,5	78	8.65€

S05A408S 50.00€

Jogo de 8 chaves de caixa com ponta macho hexagonal de impacto 1/2"

Composição:

S05A4 Chaves: H5; H6; H8; h10; H12; H14; H17 e H19



S05A6105S 87.00€

Jogo de 5 bits hexagonais de impacto 3/4"

Composição:

S05A6 Chaves: 14; 17; 19; 22 e 24mm de 88mm



S05A6H

Chave de impacto hexagonal de 3/4"



Ref.	Medida (mm)	Comprimento (mm)	Preço
			15.00€
S05A6H14	14	88	15.00€
S05A6H17	17	88	15.00€
S05A6H19	19	88	15.00€
S05A6H22	22	88	15.00€
S05A6H24	24	88	15.00€

S06A4T

Chaves de caixa com ponta macho torx de impacto de 1/2"



Ref.	Medida	Preço
S06A4T20	T20	8.15€
S06A4T27	T27	8.15€
S06A4T30	T30	8.15€
S06A4T40	T40	8.20€
S06A4T45	T45	8.20€
S06A4T50	T50	8.20€
S06A4T55	T55	8.25€
S06A4T60	T60	8.25€
S06A4T70	T70	8.30€
S06A4T80	T80	8.30€

S06A408S 45.00€

Jogo de 8 chaves de caixa com ponta macho torx de impacto 1/2"

Composição:

S06A4 Chaves: T30; T40; T45; T50; T55; T60; T70 e T80



S64A4106S 38.00€

Jogo de 6 chaves de impacto XZN de 1/2"

Composição:

S064A4 3 Chaves: M14; M16 e M18 de 45mm
3 Chaves: M14; M16 e M18 de 76mm



S64A6306S 68.00€

Jogo de 6 chaves de impacto XZN e Torx de 3/4"

Composição:

S064A6 4 Chaves Torx: T70; T80; T90 e T100 de 61mm
2 Chaves XZN: M16 e M18 de 61mm



S12A4525S 185.00€

Jogo de 25 chaves impacto magnéticas de 1/2"

Composição:

Chaves de 1/2": 3/8"; 7/16"; 1/2"; 9/16"; 5/8"; 11/16"; 3/4"; 13/16"; 7/8"; 15/16" e 1"
Chaves de 1/2": 10 a 21mm
Cardan de 1/2"
Extensão 80mm



S18A4117M 16.00€

Chave impacto magnética de 17 mm de 1/2"



S18A4119M 15.50€

Chave impacto magnética de 19 mm de 1/2"



S18A4121M 15.80€

Chave impacto magnética de 21 mm de 1/2"



S18A4103MS 52.50€

Jogo de 3 chaves impacto magnéticas de 1/2"

Composição:

Chaves: 17; 19 e 21mm



S18A41

Chave de impacto longa para rodas



Ref.	Quadra	Medida (mm)	D (mm)	L (mm)	Cor	Preço
S18A4115	1/2"	15	25	85	Laranja	6.15€
S18A4117	1/2"	17	27	85	Azul	7.45€
S18A4119	1/2"	19	28,5	85	Verde	7.65€
S18A4121	1/2"	21	31	85	Vermelho	7.85€

S18AD41

Chave de impacto extra longa para rodas



Ref.	Quadra	Medida (mm)	D (mm)	L (mm)	Cor	Preço
S18AD4117	1/2"	17	27	150	Azul	16.35€
S18AD4119	1/2"	19	28,5	150	Verde	16.65€
S18AD4121	1/2"	21	31	150	Vermelho	16.85€

S03AD4317

7.30€

Chave impacto de 17 mm de 1/2"

S03AD4319

7.30€

Chave impacto de 19 mm de 1/2"

S03AD4321

7.40€

Chave impacto de 21 mm de 1/2"

S03AD4303S

23.00€

Jogo de 3 chaves impacto de 1/2"

Composição:

Ref.	Medida (mm)
S03AD4317	17
S03AD4319	19
S03AD4321	21

S03AD4307S

67.50€

Jogo de 7 chaves impacto de 1/2"

Composição:

Ref.	Medida (mm)	Ref.	Medida (mm)
S03AD4317	17	S03AD4323	23
S03AD4319	19	S03AD4324	24
S03AD4321	21	S03AD4327	27
S03AD4322	22		

S03AD4517

16.50€

Chave impacto longa de 17 mm de 1/2"

S03AD4519

16.70€

Chave impacto longa de 19 mm de 1/2"

S03AD4521

17.10€

Chave impacto longa de 21 mm de 1/2"

S03AD4503S

57.00€

Jogo de 3 chaves impacto longas de 1/2"

Composição:

Ref.	Medida (mm)	Compr. (mm)
S03AD4517	17	150
S03AD4519	19	150
S03AD4521	21	150

S46TE80

14.00€

Barra de torque 110Nm de 1/2"

Comprimento: 196mm

Cor: azul



Alicates

com revestimento antideslizante

P018 14.70€

Alicate universal
Comprimento: 200mm



P038 11.00€

Alicate de corte diagonal
Comprimento: 200mm



P046 9.70€

Alicate de corte
Comprimento: 160mm



P068 11.70€

Alicate de pontas
Comprimento: 200mm
Capacidade máxima: Ø3,0mm



P068A 10.30€

Alicate de pontas
Comprimento: 200mm



P079 17.00€

Alicate universal
Comprimento: 220mm
Capacidade máxima: Ø3,0mm



P6008 7.90€

Alicate regulável (2 posições)
Comprimento: 200mm



P61

Alicate de corte frontal

Ref.	Compr. (mm)	Preço
P6106	160	9.50€
P6108	200	11.30€



P9506 13.70€

Alicate corta fios
Comprimento: 165mm
Peso: 188g



P27

Alicate ajustável

Ref.	Compr. (mm)	Preço
P2706	160	10.00€
P2710	250	13.20€
P2712	330	20.80€



P2810 13.70€

Alicate ajustável
Comprimento: 250mm



com mola

P266 9.50€

Alicate de freios internos e externos (pontas intermutáveis)

Capacidade: freios de 12 a 50mm
Pontas de: Ø1,2 e 1,5mm
Pontas direitas de: 45 e de 90°



AG010002S 45.00€

Jogo de 4 alicates de freios

Composição:

- AG010002 Alicate de freios interiores com pontas direitas
- AG010005 Alicate de freios interiores com pontas curvas
- AG010008 Alicate de freios exteriores com pontas direitas
- AG010011 Alicate de freios exteriores com pontas curvas



AG01000

Alicate de freios interiores (pontas direitas)

Ref.	Compr. (mm)	Preço
AG010002	175	9.30€
AG010003	230	14.00€



AG01000

Alicate de freios interiores (pontas curvas)

Ref.	Compr. (mm)	Preço
AG010005	175	9.50€
AG010006	230	13.90€



AG01000
Alicate de freios exteriores (pontas direitas)

Ref.	Compr. (mm)	Preço
AG010008	175	9.50€
AG010009	230	13.30€

AG01000
Alicate de freios exteriores (pontas curvas 90°)

Ref.	Compr. (mm)	Preço
AG010011	175	9.70€
AG010012	230	13.70€

P9508C
16.90€
Alicate de freios interiores (pontas curvas)

 Comprimento: 216mm
 Capacidade: 10-32mm

P9508D
16.90€
Alicate de freios exteriores (pontas curvas)

 Comprimento: 216mm
 Capacidade: 10-32mm

P9902S
225.00€
Jogo de 2 alicate de freios

Composição:

P9920A Alicate de freios internos

P9920C Alicate de freios externos

Capacidade: 165-300mm

P7101
16.50€
Mini alicate de pontas curvas 45° (desenho ergonómico)

 Comprimento: 140mm
 Peso: 90g

P7102
15.50€
Mini alicate de corte frontal (desenho ergonómico)

 Comprimento: 110mm
 Peso: 90g

Alicates
com revestimento antideslizante e mola
P7103
14.30€
Mini alicate de corte diagonal (desenho ergonómico)

 Comprimento: 115mm
 Peso: 90g

P7104
14.30€
Mini alicate universal (desenho ergonómico)

 Comprimento: 120mm
 Peso: 90g

P7105
13.80€
Mini alicate de pontas direitas (desenho ergonómico)

 Comprimento: 135mm
 Peso: 90g

P8006
16.70€
Alicate universal

Comprimento: 160mm

P8106
16.80€
Alicate pontas longas

Comprimento: 160mm

P8606
17.00€
Alicate de corte diagonal

Comprimento: 160mm

P9006
16.40€
Alicate pontas chatas

Comprimento: 160mm



Alicates

com revestimento antideslizante

Símbolo				
Tipo de material	Macio	Dureza média	Duro	Corda de piano
Exemplo	Cobre, alumínio	Ferro	Aço	Aço duro/ mola
Tensão N/mm ²	220-250	750-800	1700-1800	2200-2300

P051

Alicate corta cabos



Ref.	Compr. (mm)	mm ²	Ø mm	Preço
P0516	160	22	9.5	14.50€
P0518	200	38	11.5	16.50€

P0118

Alicate universal







Ref.	Compr. (mm)					Preço
P0118	200	5.0	3.5	2.4	2.0	15.60€

P081

Alicate universal







Ref.	Compr. (mm)					Preço
P0816	160	4.0	2.8	1.8	1.4	11.20€
P0817	180	4.0	3.0	2.0	1.6	12.50€
P0818	200	4.0	3.0	2.0	1.6	15.00€

P091

Alicate de corte (trabalho intensivo)







Ref.	Compr. (mm)					Preço
P0916	160	4.0	3.0	2.0	1.6	13.20€
P0917	180	5.0	3.5	2.4	2.0	14.50€
P0918	200	5.0	3.5	2.4	2.0	15.00€

P101

Alicate de corte







Ref.	Compr. (mm)					Preço
P1016	160	4.0	3.0	2.0	1.6	12.00€
P1017	180	4.0	3.0	2.0	1.6	13.30€

P111

Alicate de pontas







Ref.	Compr. (mm)					Preço
P1116	160	4.0	2.8	1.8	1.4	11.00€
P1118	200	4.0	3.0	2.0	1.6	13.60€

P121

Alicate de pontas curvas



Ref.	Compr. (mm)					Preço
P1216	160	4.0	2.8	1.8	1.4	11.60€
P1218	200	4.0	3.0	2.0	1.6	14.00€

P1416

Alicate de pontas chatas

Comprimento: 160mm



11.50€

P1516

Alicate de descarnar

Comprimento: 160mm



12.20€

P4016

Alicate de pontas redondas

Comprimento: 160mm



11.60€

P6116

Alicate de corte frontal

Ref.	Compr. (mm)					Preço
P6116	160	4.0	3.0	2.0	1.6	12.50€



P2811

Alicate ajustável

Ref.	Compr. (mm)	Preço
P28110	240	17.30€
P28112	300	25.00€



P2821

Alicates ajustável

Ref.	Compr. (mm)	Preço
P28210	240	22.00€
P28212	300	29.80€

P08104S

Jogo de 4 alicates

Composição:

P0817 Alicates universal

P0917 Alicates de corte diagonal

P1118 Alicates de pontas direitas

P2810 Alicates de ajustável



71.00€

PESD05

Alicates anti-estático pontas curvas (com mola)

Comprimento: 150mm



9.80€

PESD10

Alicates anti-estático de corte (com mola)

Comprimento: 115mm



9.20€

PESD11

Alicates anti-estático de pontas (com mola)

Comprimento: 130mm



9.60€

P178

Turquês de carpinteiro

Comprimento: 200mm



13.70€

P1810

Turquês de cofragens

Comprimento: 250mm



13.60€

Alicates

com revestimento antideslizante

P2010LA

11.40€

Tesoura articulada

Corte esquerda

Comprimento: 250mm

Peso: 395g

Capacidade de corte: Aço: 1,2mm | Aço inox: 0,7mm

P2010RA

11.30€

Tesoura articulada

Corte direita

Comprimento: 250mm

Peso: 395g

Capacidade de corte: Aço: 1,2mm | Aço inox: 0,7mm

P2010SA

11.40€

Tesoura articulada

Lâminas direitas

Comprimento: 200mm

P22

Tesoura de cortar chapa

Ref.	Compr. (mm)	Preço
P2208A	205	11.30€
P2212A	305	17.80€

P2205E

10.70€

Tesoura de eletricitista

P15808

13.50€

Tesoura multifunções

Lâminas em aço inox de 3mm

Comprimento: 206mm

P43

Alicates corta cabos

Ref.	Compr. (mm)	Peso	Capac. de corte	Preço
P4318	450	1 570g	fio 5mm cabo 10mm	39.00€
P4330	750	4 200g	fio 9mm cabo 14mm	69.00€



Alicates

P4318-RK 17.80€

Kit de reparação

P4330-RK 36.80€

Kit de reparação

P6424 37.50€

Alicate corta cabos

Comprimento: 600mm
Peso: 2 700g
Capacidade de corte: Ø 10mm



P7601 18.30€

Alicate longo de pontas direitas

Comprimento: 275mm



P7602 18.50€

Alicate longo de pontas curvas 45°

Comprimento: 275mm



P7603 18.50€

Alicate longo de pontas curvas 90°

Comprimento: 275mm



P7608 19.50€

Alicate longo de pontas redondas Ø13mm

Comprimento: 275mm



P7719 32.30€

Alicate longo de torcer arame

Comprimento: 270mm
Peso: 360g
Capacidade: Ø 0,55mm



V1001 15.00€

Alicate de rebitar (trabalho intensivo)

Inclui 4 bicos: 2,4; 3,2; 4 e 4,8mm



V1002 50.00€

Alicate de rebitar extensível

Inclui 4 bicos: 2,4; 3,2; 4 e 4,8mm



V1002-RK 1.70€

Kit de reparação para alicate de rebitar extensível V1002

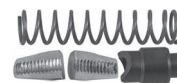

V1003 36.50€

Alicate de rebitar (trabalho intensivo)

Inclui bicos: 6,4; 3,2; 4 e 4,8mm



V1005 18.80€

Alicate de rebitar (bicos intermutáveis)

Inclui bicos: 2,4; 3,2; 4 e 4,8mm



V21

Alicate de rebitar (bicos intermutáveis)

Ref.	Bicos (mm)	Preço
V2101	2,4; 3,2; 4 e 4,8 mm	27.50€
V2102	3,2; 4; 4,8 e 6,4 mm	40.50€



V1103 33.50€

Alicate de rebitar fêmeas

Capacidade: M3; M4; M5 e M6



V2401 58.50€

Alicate de rebitar fêmeas

Capacidade: M5; M6; M8 e M10



V2401

Mandril

Ref.	Medida	Preço
V2401-M5A	M5	3.00€
V2401-M6A	M6	3.00€
V2401-M8A	M8	3.00€
V2401-M10A	M10	3.00€



V2401

Bico

Ref.	Medida	Preço
V2401-M5B	M5	3.00€
V2401-M6B	M6	3.00€
V2401-M8B	M8	3.00€
V2401-M10B	M10	3.00€

AR030058

105.00€

 Alicates de cravar terminais
Intermutável para 6 tipos de terminais

V1311

Alicates de cravar terminais

Ref.	Caraterísticas	Preço
V1311A	Terminais isolados	38.00€
V1310C	Fichas cabo coaxial	37.00€
V1311E	Terminais não isolados	37.00€
V1310F	Fichas RJ45	41.50€

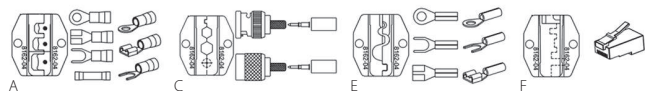
V1310

Acessórios para alicate de cravar V1310

Ref.	Terminais	Preço
V1310A-11	Mordentes	13.00€
V1310B-11	Mordentes	13.00€
V1310E-11	Mordentes	13.00€
V1310F-11	Mordentes RJ45	18.00€
V1310G-11	Mordentes AWG 22-10 (0,5-10mm ²)	18.00€
V1310J-11	Mordentes AWG 10-60 (6-16mm ²)	18.00€

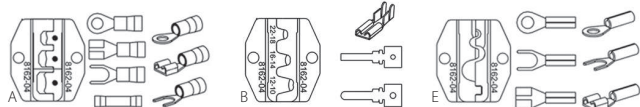
V1401

8.80€

Alicates de cravar terminais/ descarnar fios

V1403

14.50€

Alicates de cravar (trabalho intensivo)

Alicates
V1501

20.90€

Alicates de descarnar (trabalho intensivo)

Parafuso de ajuste à espessura do fio

Comprimento: 172mm

Peso: 305g

V1505

16.30€

Alicates de descarnar

P30M10A

11.80€

Alicates de pressão bicos direitos

Comprimento: 250mm

Peso: 540g

P32M

Alicates de pressão bocas côncavas

Ref.	Compr. (mm)	Preço
P32M07A	180	9.80€
P32M10A	250	11.00€

P36M09A

10.30€

Alicates de pressão bicos longos

Comprimento: 230mm

P37M

Alicates de pressão pescoço de cisne

Ref.	Compr. (mm)	Preço
P37M11A	280	17.10€
P37M18A	450	30.20€

P38M

Alicates de pressão para soldadura

Ref.	Compr. (mm)	Preço
P38M09A	230	15.00€
P38M11A	280	17.80€



Alicates

P52A10 37.00€

Alicate de pressão boca direita ajustável

Comprimento: 250mm



P52B10 33.00€

Alicate de pressão boca curva ajustável

Comprimento: 250mm



P52C10 42.00€

Alicate de pressão boca curva ajustável

Comprimento: 250mm



P52D12 39.00€

Alicate de pressão boca longa ajustável

Comprimento: 300mm



P52M10 15.00€

Alicate de pressão bocas recurvadas

Comprimento: 250mm



P53M

Alicate pescoço cisne maxilas oscilantes

Ref. Compr. (mm) Preço

P53M06 152 11.50€

P53M11 280 19.30€

P53M18 460 31.00€

P54M

Alicate de pressão para latoeiros

Ref. Compr. (mm) Preço

P54M08A 205 13.00€

P54M10A 250 16.70€



P52N10 18.50€

Alicate de pressão boca larga

Comprimento: 240mm



P1019 17.00€

Alicate de pressão com corrente

Comprimento: 230mm

Capacidade: 457mm



P9409 14.80€

Alicate de pressão



P30M07C 12.50€

Alicate de pressão isolado

Comprimento: 175mm

Peso: 360g



P32M

Alicate de pressão isolado com mordentes curvos e corta fios

Ref. Compr. (mm) Peso (g) Preço

P32M05C 125 175 10.80€

P32M10C 250 560 13.80€



P36M

Alicate de pressão isolado bicos longos com corta fios

Ref. Compr. (mm) Peso (g) Preço

P36M06C 152 180 11.00€

P36M09C 270 560 13.00€



P78M10C 15.50€

Alicate de pressão isolado

Comprimento: 250mm

P32M03S 37.00€

Jogo de 3 alicates de pressão

Ref. Características Compr. (mm)

P36M06S Bicos longos 160

P32M07S Bocas côncavas 180

P32M10S Bocas côncavas 250



P7801

23.30€

Alicate de pressão multifunções
Garras tipo W



P7802

23.30€

Alicate de pressão multifunções
Garras tipo JJ



P7803

23.00€

Alicate de pressão multifunções
Garras tipo LL



P7804

22.50€

Alicate de pressão multifunções
Garras tipo J



P7805

22.50€

Alicate de pressão multifunções





D70S

Chaves fenda de impacto

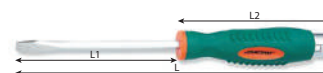

Ref.	Medida (mm)	L1 (mm)	L2 (mm)	L (mm)	Preço
D70S475	4	75	107	182	3.10€
D70S5100	5,5	100	107	207	3.90€
D70S6125	6,5	125	127	252	4.80€
D70S6150	6,5	150	127	277	5.20€
D70S8150	8	150	144	294	6.80€
D70S8175	8	175	144	319	7.10€
D70S9175	9,5	175	144	319	7.40€
D70S9250	9,5	250	144	394	8.60€

D70P

Chave phillips de impacto

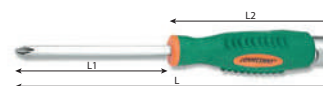

Ref.	Medida	L1 (mm)	L2 (mm)	L (mm)	Preço
D70P175	PH1	75	107	182	3.90€
D70P2100	PH2	100	127	277	4.60€
D70P3125	PH3	125	144	269	6.90€
D70P3150	PH3	150	144	299	7.30€

D70PP07S

41.00€

Jogo de 7 chaves fenda/ phillips de impacto

Composição/ medidas (mm):

- 3 Chaves fenda impacto: 5,5x100; 6,5x125 e 8x150
- 3 Chaves phillips: PH1x75; PH2x100 e PH3x125
- 1 Chave extensível com ponta magnética



D70PP10S

53.00€

Jogo de 10 chaves fenda/ phillips de impacto

Composição/ medidas (mm):

- D70S Chaves fenda: 5,5x100; 6,5x125; 8x150; 9,5x175 e 6,5x38
- D70P Chaves phillips: PH1x75; PH2x100; PH3x125 e PH2x38
- Ponteiro magnético



DV14PP-TP

3.00€

Busca-polos

220 - 250 v

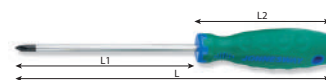

D71P
Chave phillips

Ref.	Medida	L1 (mm)	L2 (mm)	L (mm)	Preço
D71P060	PH0	60	90	150	2.25€
D71P138	PH1	38	56	94	2.15€
D71P180	PH1	80	110	190	2.45€
D71P238	PH2	38	56	94	2.15€
D71P1100	PH1	100	110	210	2.75€
D71P1150	PH1	150	110	250	2.95€
D71P1300	PH1	300	110	410	4.00€
D71P2100	PH2	100	119	219	3.10€
D71P2150	PH2	150	119	269	3.35€
D71P2250	PH2	250	119	369	5.00€
D71P2400	PH2	400	119	519	6.35€
D71P3150	PH3	150	129	279	4.30€
D71P3250	PH3	250	129	279	6.30€
D71P3400	PH3	400	129	529	8.30€
D71P4200	PH4	200	129	329	5.70€

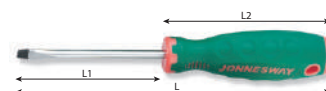
D71S
Chave fenda

Ref.	Medida (mm)	L1 (mm)	L2 (mm)	L (mm)	Preço
D71S250	2,4	50	72	122	2.00€
D71S360	3	60	72	132	2.05€
D71S4100	4	100	90	190	2.30€
D71S4150	4	150	110	260	3.10€
D71S4200	4	200	90	290	3.45€
D71S480	4	80	90	170	2.15€
D71S5125	5,5	125	110	235	2.70€
D71S5200	5,5	200	110	310	3.15€
D71S5300	5,5	300	110	410	4.25€
D71S538	5,5	38	56	94	2.30€
D71S575	5,5	75	110	185	2.70€
D71S638	6,5	38	56	94	2.15€
D71S6100	6,5	100	119	219	3.15€
D71S6150	6,5	150	119	269	3.35€
D71S6400	6,5	400	119	519	6.25€
D71S8150	8	150	129	279	4.30€
D71S8200	8	200	129	329	5.00€
D71S8300	8	300	129	429	6.15€
D71S8500	8	500	129	629	9.15€
D71S9175	9,5	175	129	304	4.75€
D71S10250	10	250			5.80€

D71T

Chave torx

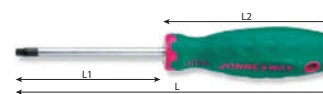

Ref.	Medida	L1 (mm)	L2 (mm)	L (mm)	Preço
D71T5	T5	60	73	132	2.00€
D71T6	T6	60	73	132	2.05€
D71T7	T7	60	73	132	2.10€
D71T8	T8	60	73	132	2.15€
D71T9	T9	60	73	132	2.15€
D71T10	T10	80	90	170	2.20€
D71T15	T15	80	90	170	2.20€
D71T20	T20	100	110	210	2.55€
D71T25	T25	100	110	210	2.60€
D71T27	T27	100	119	219	3.50€
D71T30	T30	125	119	244	3.70€
D71T40	T40	150	129	279	4.70€
D71T45	T45	200	129	329	4.80€
D71T50	T50	200	129	329	5.60€

D71400T

Chave torx longa



Ref.	Medida	Compr. (mm)	Preço
D71400T10	T10	400	5.60€
D71400T15	T15	400	5.90€
D71400T20	T20	400	6.50€
D71400T25	T25	400	6.60€
D71400T27	T27	400	7.80€
D71400T30	T30	400	8.30€

D71Z

Chave pozi

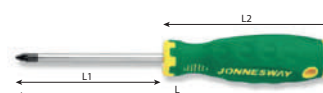

Ref.	Medida	L1 (mm)	L2 (mm)	L (mm)	Preço
D71Z060	PZ0	60	90	150	2.15€
D71Z138	PZ1	38	56	94	2.25€
D71Z180	PZ1	80	110	190	2.55€
D71Z2100	PZ2	100	119	219	3.20€
D71Z3150	PZ3	150	129	279	4.60€
D71Z4200	PZ4	200	129	329	5.20€

D725N

Chaves "T" de punho antideslizante com caixa sextavada



Ref.	Medida (mm)	Compr. (mm)	Preço
D725N06	6	298	5.50€
D725N07	7	298	5.50€
D725N08	8	298	5.50€
D725N09	9	298	5.70€
D725N10	10	298	5.70€
D725N11	11	298	5.80€
D725N12	12	298	6.00€
D725N13	13	298	6.00€

D715N

Chave caixa com punho



Ref.	Medida	L1 (mm)	L2 (mm)	L (mm)	Preço
D715N05	5	125	119	244	4.50€
D715N07	7	125	119	244	4.70€
D715N08	8	125	119	244	4.80€
D715N10	10	125	119	244	5.00€
D715N12	12	125	119	244	5.30€
D715N13	13	125	119	244	5.70€

D71C105S

15.50€

Jogo de 5 chaves fenda/ phillips

Composição/ medidas (mm):

Chaves fenda: 4x80; 5,5x125 e 6,5x150

Chaves phillips: PH1x80 e PH2x100

D71C106S

16.50€

Jogo de 6 chaves fenda/ phillips

Composição/ medidas (mm):

Chaves fenda: 3x60; 5,5x125 e 6,5x150

Chaves phillips: PH0x60; PH1x80 e PH2x100

D71PP08S

30.50€

Jogo de 8 chaves fenda/ phillips com punho antideslizante

Composição/ medidas (mm):

D71S Chaves fenda: 6,5x38; 4x80; 5,5x125 e 6,5x150

D71P Chaves phillips: PH2x38; PH1x80; PH2x100 e PH3x150

D71PP16S

64.00€

Jogo de 16 chaves fenda/ phillips com punho antideslizante

Composição/ medidas (mm):

D71S Chaves fenda: 6,5x38; 3x50; 6,5x100; 5,5x125; 5,5x200; 8,5x150; 5,5x75 e 4x150

D71P Chaves phillips: PH2x38; PH1x150; PH0x60; PH1x80; PH2x100; PH2x150; PH3x150 e PH1x38

D71T107S

23.20€

Jogo de 7 chaves torx com punho antideslizante

Composição/ medidas (mm):

Chaves: T10; T15; T20; T25; T27; T30 e T40

D71T109S

27.00€

Jogo de 9 chaves torx com punho antideslizante

Composição/ medidas (mm):

Chaves: T8; T9; T10; T15; T20; T25; T27; T30 e T40

D71Z105S

15.50€

Jogo de 5 chaves fenda/ pozi

Composição/ medidas (mm):

Chaves fenda: 4x80; 5,5x125 e 6,5x150

Chaves pozi: PZ1x80 e PZ2x100



D71Z107S

27.00€

Jogo de 7 chaves fenda/ pozi com punho antideslizante

Composição/ medidas (mm):

Chaves fenda: 4x100; 5,5x125; 6,5x150 e 8x175

Chaves pozi: PZ1x80; PZ2x100 e PZ3x150



D3750P08S

17.70€

Jogo de 8 chaves de precisão fenda/ phillips

Composição:

Ref.	Chave	Ponta (mm)	Compr. (mm)
D3750S30	fenda	3	50
D3750S24	fenda	2,4	50
D3750S20	fenda	2	50
D3750S16	fenda	1,6	50
D3750S10	fenda	1	50
D3750P1	phillips	nº1	50
D3750P0	phillips	nº0	50
D3750P00	phillips	nº00	50



D3750T08S

17.70€

Jogo de 8 chaves de precisão torx

Composição:

Ref.	Medida (mm)	Ref.	Medida (mm)
D3750T20	T20x50	D3750T8	T8x50
D3750T15	T15x50	D3750T7	T7x50
D3750T10	T10x50	D3750T6	T6x50
D3750T9	T9x50	D3750T5	T5x50



D3750T

Chave de precisão torx

Ref.	Medida (mm)	Preço
D3750T5	T5x50	1.80€
D3750T6	T6x50	1.80€
D3750T7	T7x50	1.80€
D3750T8	T8x50	1.80€
D3750T9	T9x50	1.80€
D3750T10	T10x50	1.80€
D3750T15	T15x50	1.90€
D3750T20	T20x50	1.90€



D3750T18S

15.50€

Jogo de 8 chaves de precisão

Composição:

Ref.	Medida (mm)	Ref.	Medida (mm)
D3750P00	P00x50	D3750T7	T7x50
D3750T4	T4x50	D3750A1	garfo 50
D3750T5	T5x50	D3750A2	inclinação 50
D3750T6	T6x50	D3750A3	agulha 50



DR0253S

46.90€

Jogo de bits e porta bits flexível

Composição/ medidas (mm):

- Porta bits flexível
- Bits phillips: #1; #2 e #3
- Bits fenda: 3; 4; 5,5; e 7
- Bits pozi: #0; #1; #2; e #3
- Bits hexagonal: 2; 2,5; 3; 4; 5 e 6
- Bits torx tamper proof: T8; T10; T15; T20; T25; T27; T20 e T40
- Bits torx: T6; T8; T9; T10; T15; T20; T25; T27; T30 e T40
- Adaptador 1/4" hexagonal
- Adaptador magnético



DR0107S
12.30€
Jogo de bits longos e porta bits

Composição/ medidas (mm):

- Porta bits
- Bits duplo 65mm
- Pozi 1/ fenda 5mm
- Pozi 2/ fenda 6mm
- Pozi 3/ fenda 7mm
- Hexagonal 3mm/ 4mm
- Hexagonal 5mm/ 6mm
- Phillips/ fenda 6mm

DBT31B
15.50€
Jogo de porta pontas de punho

Composição/ medidas (mm):

- Porta pontas de punho
- Pontas phillips
- Pontas fenda
- Pontas pozi
- Pontas hexagonais
- Pontas torx

RD01032S
32.00€
Jogo roquete com bits 1/4" com 32 peças

Composição:

- Roquete 1/4" de 60 dentes
- Porta bits magnético
- Bits phillips
- Bits hexagonais
- Bits quadrados
- Bits pozi
- Bits torx
- Bits fenda
- Bits torx tamperproof

S08H208S
6.20€
Jogo de porta pontas angular (90°)

Composição:

- 7 Pontas 1/4"

Chaves
S14A4
Chave para retirar fêmeas danificadas 1/2"

Ref.	Medida (mm)	Comp. (mm)	Preço
S14A4117	17		10.00€
S14A4118	18,5		10.10€
S14A4120	20	25	10.40€
S14A4121	21,5		10.50€
S14A4123	23	30	11.00€
S14A4124	24,5	30	11.10€
S14A4126	26	30	11.30€
S14A4127	27,5	33	11.50€

S14A4108S
86.00€
Jogo de 8 chaves para retirar fêmeas danificadas 1/2"

Composição/ medidas (mm):

Chaves: 17; 18,5; 20; 21,5; 23; 24,5; 26 e 27,5

S29H2133S
11.70€
Jogo de porta bits 1/4" com 33 peças

Composição:

- Porta bits magnético
- Bits torx
- Bits torx tamperproof
- Bits perfil "Tri Wing"
- Bits perfil "Spanner"
- Bits hexagonais

S29TP23S
28.50€
Jogo de bits Torx Plus de 1/4" com 23 peças

Composição:

- 5 Bits torx plus tamperproof de 1/4": TS10H; TS15H; TS20H; TS25H e TS30H
- 5 Bits torx plus tamperproof de 10mm: TS40H; TS45H; TS50H; TS55H e TS60H
- 5 Bits torx plus de 1/4": IP10H; IP15H; IP20H; IP25H e IP30H
- 5 Bits torx plus de 10mm: IP40H; IP45H; IP50H; IP55H e IP60H
- 1 Adaptador 3/8" x 10mm:
- 1 Adaptador 1/4" x 1/4"
- 1 Porta bits 1/4" x 1/4" com 60mm comprimento

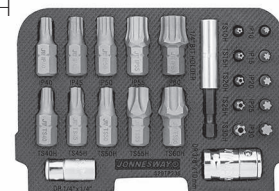

Chaves

as pontas bits são vendidas em embalagens de 10 unidades
os preços indicados são por unidade

D125H

Pontas/ bits de 1/4" hexagonais



Ref.	Medida (mm)	Compr. (mm)	Preço
D125H015A	1,5	25	0.30€
D125H020A	2	25	0.30€
D125H025A	2,5	25	0.30€
D125H030A	3	25	0.30€
D125H040A	4	25	0.30€
D125H050A	5	25	0.30€
D125H060A	6	25	0.30€
D125H060A	7	25	0.30€

D125T

Pontas/ bits de 1/4" torx



Ref.	Medida (mm)	Compr. (mm)	Preço
D125T06B	T6	25	0.25€
D125T08B	T8	25	0.25€
D125T10A	T10	25	0.30€
D125T15A	T15	25	0.30€
D125T20A	T20	25	0.30€
D125T25A	T25	25	0.30€
D125T27A	T27	25	0.30€
D125T30A	T30	25	0.30€
D125T40A	T40	25	0.30€

D125F

Pontas/ bits de 1/4" fenda



Ref.	Medida (mm)	Compr. (mm)	Preço
D125F4506A	0,6x4,5	25	0.30€
D125F6512A	1,2x6,5	25	0.30€
D125F8016A	1,6x8	25	0.50€

D125P

Pontas/ bits de 1/4" phillips



Ref.	Medida (mm)	Compr. (mm)	Preço
D125P1F	PH1	25	0.30€
D125P2F	PH2	25	0.30€
D125P3F	PH3	25	0.30€



D125Z

Pontas/ bits de 1/4" pozi



Ref.	Medida (mm)	Compr. (mm)	Preço
D125Z1A	PZ1	25	0.30€
D125Z2A	PZ2	25	0.30€
D125Z3A	PZ3	25	0.30€



D130H

Pontas/ bits de 10mm hexagonais



Ref.	Medida (mm)	Compr. (mm)	Preço
D130H40	4	30	0.80€
D130H50	5	30	0.80€
D130H60	6	30	0.80€
D130H70	7	30	0.80€
D130H80	8	30	0.80€
D130H100	10	30	0.90€
D130H120	12	30	1.00€

D130T

Pontas/ bits de 10mm torx



Ref.	Medida (mm)	Compr. (mm)	Preço
D130T20	T20	30	0.80€
D130T25	T25	30	0.80€
D130T30	T30	30	0.80€
D130T40	T40	30	0.80€
D130T45	T45	30	0.80€
D130T50	T50	30	0.90€
D130T55	T55	30	0.90€

D150F

Pontas/ bits de 1/4" fenda



Ref.	Medida (mm)	Compr. (mm)	Preço
D150F5510A	1x5,5	50	0.50€
D150F6512A	1,2x6,5	50	0.50€
D150F8012A	1,2x8	50	0.60€



D150P

Pontas/ bits de 1/4" phillips



Ref.	Medida (mm)	Compr. (mm)	Preço
D150P1A	PH1	50	0.50€
D150P2A	PH2	50	0.50€
D150P3A	PH3	50	0.50€

D150Z

Pontas/ bits de 1/4" pozi



Ref.	Medida (mm)	Compr. (mm)	Preço
D150Z1A	PZ1	50	0.50€
D150Z2A	PZ2	50	0.50€
D150Z3A	PZ3	50	0.50€

D150H

Pontas/ bits de 1/4" hexagonais

Ref.	Medida (mm)	Compr. (mm)	Preço
D150H030A	3	50	0.50€
D150H040B	4	50	0.50€
D150H050A	5	50	0.50€
D150H060B	6	50	0.50€
D150H070B	7	50	0.60€
D150H080B	8	50	0.60€

D150T

Pontas/ bits de 1/4" torx

Ref.	Medida (mm)	Compr. (mm)	Preço
D150T20A	T20	50	0.50€
D150T25A	T25	50	0.50€
D150T27A	T27	50	0.50€
D150T30A	T30	50	0.50€
D150T40A	T40	50	0.50€

D100MN

Ponta hexagonal magnética de 1/4" para fêmeas

Ref.	Medida (mm)	Compr. (mm)	Preço
D100MN08M	8	100	2.80€
D100MN10M	10	100	3.40€
D100MN12M	12	100	3.60€
D100MN13M	13	100	3.60€
D100MN14M	14	100	3.80€

D10M3

Pontas/ bits de 10mm estriado XZN

Ref.	Medida (mm)	Compr. (mm)	Preço
D10M30M05A	M5	30	0.80€
D10M30M06A	M6	30	0.80€
D10M30M08A	M8	30	0.80€
D10M30M10A	M10	30	0.80€
D10M30M12A	M12	30	1.00€
D10M30M14A	M14	30	1.10€

D10M7

Pontas/ bits de 10mm estriado XZN

Ref.	Medida (mm)	Compr. (mm)	Preço
D10M75M05A	M5	75	1.30€
D10M75M06A	M6	75	1.30€
D10M75M08A	M8	75	1.30€
D10M75M10A	M10	75	1.30€
D10M75M12A	M12	75	1.75€
D10M75M14A	M14	75	1.90€

D175H

Pontas/ bits de 10mm hexagonais

Ref.	Medida (mm)	Compr. (mm)	Preço
D175H40	4	75	1.25€
D175H50	5	75	1.25€
D175H60	6	75	1.25€
D175H70	7	75	1.30€
D175H80	8	75	1.35€
D175H100	10	75	1.35€
D175H120	12	75	1.70€

D175T

Pontas/ bits de 10mm torx longo

Ref.	Medida (mm)	Compr. (mm)	Preço
D175T20	T20	75	1.25€
D175T25	T25	75	1.25€
D175T30	T30	75	1.25€
D175T40	T40	75	1.25€
D175T45	T45	75	1.25€
D175T50	T50	75	1.25€
D175T55	T55	75	1.30€

D125TT

Pontas/ bits de 1/4" torx tamper proof

Ref.	Medida (mm)	Compr. (mm)	Preço
D125TT08B	T8	25	0.30€
D125TT10B	T10	25	0.30€
D125TT15B	T15	25	0.30€
D125TT20B	T20	25	0.30€
D125TT25B	T25	25	0.30€
D125TT27B	T27	25	0.30€
D125TT30B	T30	25	0.30€
D125TT35B	T35	25	0.30€
D125TT40B	T40	25	0.30€

D150MH

Porta pontas/ bits magnético para bits de 1/4"

Ref.	Medida (mm)	Compr. (mm)	Preço
D150MH1AD	10	50	2.00€

D150MH

Porta pontas/ bits magnético de encaixe rápido

Ref.	Medida (mm)	Compr. (mm)	Preço
D150MH1QD	10,5	50	4.50€

D165MN



Ponta hexagonal magnética de 1/4" para fêmeas

Ref.	Medida (mm)	Compr. (mm)	Preço
D165MN06M	6	65	1.95€
D165MN07M	7	65	1.95€
D165MN08M	8	65	2.00€
D165MN10M	10	65	2.50€
D165MN12M	12	65	3.10€
D165MN13M	13	65	3.10€

S29H2180S

32.50€

Conjunto de 180 pontas

Composição:

- phillips
- pozi
- hexagonais
- torx



H01SA



Chaves hexagonais curtas antideslizante

Ref.	Medida (mm)	L1 (mm)	L2 (mm)	Preço
H01SA115	1,5	46,5	15,5	0.40€
H01SA120	2	52	18	0.40€
H01SA125	2,5	58,5	20,5	0.40€
H01SA130	3	66	23	0.60€
H01SA140	4	74	29	0.90€
H01SA150	5	85	33	1.00€
H01SA160	6	96	38	1.50€
H01SA180	8	108	44	1.60€
H01SA1100	10	122	50	2.60€

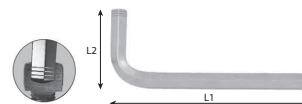

H01MH118S



33.70€

Jogo de 18 chaves hexagonais curtas

Composição/ medidas (mm):

- Chaves: 1,5; 2; 2,5; 3; 3,5;
- 4; 4,5; 5; 5,5; 6; 7; 8; 9; 10;
- 12; 14; 17 e 19



H01SA109S



9.70€

Jogo de 9 chaves hexagonais curtas

Sistema especial antideslizante

Composição/ medidas (mm):

- Chaves: 1,5; 2; 2,5; 3;
- 4; 5; 6; 8 e 10



H01SM109S



9.50€

Jogo de 9 chaves hexagonais curtas

Composição/ medidas (mm):

- Chaves: 1,5; 2; 2,5; 3;
- 4; 5; 6; 8 e 10



H02MH217S



51.00€

Jogo de 17 chaves hexagonais longas SAE

Composição/ medidas:

- Chaves: 1/16"; 5/64"; 3/32";
- 7/64"; 1/8"; 9/64"; 5/32"; 3/16";
- 1/4"; 5/16"; 3/8"; 7/16";
- 1/2"; 9/16"; 5/8" e 3/4"



H02SM109S 12.00€

Jogo de 9 chaves hexagonais longas

Composição/ medidas (mm):

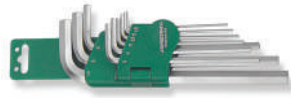
 Chaves: 1,5; 2; 2,5; 3; 4;
5; 6; 8 e 10

H02SM209S 12.00€

Jogo de 9 chaves hexagonais longas SAE

Composição/ medidas:

 Chaves: 1/16"; 5/64";
3/32"; 1/8"; 5/32";
3/16"; 1/4"; 5/16" e 3/8"

H03MH118S 61.50€

Jogo de 18 chaves hexagonais extra longas

Composição/ medidas (mm):

 Chaves: 1,5; 2; 2,5; 3; 3,5; 4;
4,5; 5; 5,5; 6; 7; 8; 9;
10; 12; 14; 17 e 19

H03SM109S 13.30€

Jogo de 9 chaves hexagonais extra longas

Composição/ medidas (mm):

 Chaves: 1,5; 2; 2,5;
3; 4; 5; 6; 8 e 10

H06SA

Chaves hexagonais extra longas com ponta esférica antideslizante

Ref.	Medida	L1 (mm)	L2 (mm)	Preço
H06SA115	1,5	91,5	15,5	0.60€
H06SA120	2	102	18	0.60€
H06SA125	2,5	114,5	20,5	0.60€
H06SA130	3	129	23	0.80€
H06SA140	4	144	29	1.10€
H06SA150	5	165	33	1.25€
H06SA160	6	186	38	1.85€
H06SA180	8	208	44	2.35€
H06SA1100	10	234	50	3.40€

H03SS109S 16.90€

Jogo de 9 chaves macho hexagonais de baixo perfil

Composição/ medidas (mm):

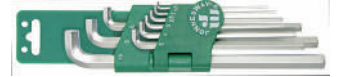
 Chaves: 1,5; 2; 2,5;
3; 4; 5; 6; 8 e 10

H05SS109S 16.50€

Jogo de 9 chaves macho hexagonais com ponta esférica de baixo perfil

Composição/ medidas (mm):

 Chaves: 1,5; 2; 2,5; 3;
4; 5; 6; 8 e 10 mm

H05SA109S 13.00€

Jogo de 9 chaves hexagonais longas com ponta esférica antideslizante

Composição/ medidas (mm):

 Chaves: 1,5; 2; 2,5; 3;
4; 5; 6; 8 e 10

H06MT109S 17.20€

Conjunto de 9 chaves hexagonais longas com ponta esférica

Composição/ medidas (mm):

 Chaves: 1,5; 2; 2,5; 3;
4; 5; 6; 8 e 10 mm

Preço

H06SA109S 13.80€

Jogo de 9 chaves hexagonais macho extra longas com ponta esférica antideslizante

H06SM209S 14.90€

Jogo de 9 chaves hexagonais com ponta esférica SAE

Composição/ medidas (mm):

 Chaves: 1/16"; 5/64";
3/32"; 1/8"; 5/32"; 3/16";
1/4"; 5/16" e 3/8"

H06SM

Chave hexagonal longa de ponta esférica SAE

Ref.	Medida	Preço
H06SM225	3/32"	0.80€
H06SM230	1/8"	0.90€
H06SM240	5/32"	1.20€
H06SM250	3/16"	1.50€
H06SM255	7/32"	1.60€
H06SM260	1/4"	1.70€
H06SM280	5/16"	2.60€
H06SM2100	3/8"	3.60€

H06W106S



55.00€

Jogo de 6 chaves articuladas hexagonais de ponta redonda

Composição/ medidas (mm):

Chaves: 3; 4; 5; 6; 8 e 10



H07M09S



10.80€

Jogo de 9 chaves torx

Composição/ medidas (mm):

Chaves: T10; T15; T20; T25; T27; T30; T40; T45 e T50



H07MT



Chave torx em L

Ref.	Medida	Preço
H07MT10	T10	0.80€
H07MT15	T15	0.90€
H07MT20	T20	1.00€
H07MT25	T25	1.10€
H07MT27	T27	1.20€
H07MT30	T30	1.30€
H07MT40	T40	1.40€
H07MT45	T45	1.70€
H07MT50	T50	2.10€

H0816S



22.50€

Jogo de 16 chaves macho com ponta torx

Composição/ medidas (mm):

Chaves: T6; T7; T8; T9; T10; T15; T20; T25; T27; T30; T40; T45; T50; T55; T60 e T70



H08MTP09S



12.50€

Jogo de 9 chaves torx tamperproof

Composição/ medidas (mm):

Chaves: T10; T15; T20; T25; T27; T30; T40; T45 e T50



H08S110S



19.00€

Jogo de 10 chaves torx longas tamperproof

Composição/ medidas (mm):

Chaves: T9; T10; T15; T20; T25; T27; T30; T40; T45 e T50



H08ST



Chaves torx longas tamperproof

Ref.	Medida	Compr. (mm)	Preço
H08ST09085	T9	80	1.30€
H08ST10090	T10	90	1.30€
H08ST15100	T15	100	1.35€
H08ST20115	T20	112	1.45€
H08ST25130	T25	126	1.55€
H08ST27145	T27	142	1.65€
H08ST30165	T30	160	1.85€
H08ST40185	T40	180	2.25€
H08ST45205	T45	200	2.60€
H08ST50230	T50	224	3.35€



H10MB08S



32.00€

Jogo de 8 chaves hexagonais duplas de punho

Composição/ medidas (mm):

Chaves: 2x100; 2,5x100; 3x100; 4x100; 5x150; 6x150; 8x200 e 10x200



H10MB

Chave hexagonal dupla de punho com ponta esférica

Ref.	Medida	Preço
H10MB2100	2x100	2.40€
H10MB25100	2,5x100	2.45€
H10MB3100	3x100	2.45€
H10MB4100	4x100	2.50€
H10MB5150	5x150	2.90€
H10MB6150	6x150	3.25€
H10MB8200	8x200	5.00€
H10MB10200	10x200	6.30€



H10MT09S

36.50€

Jogo de 9 chaves duplas torx tamperproof com punho

Composição/ medidas (mm):

Chaves: T10x100; T15x100; T20x100; T25x100; T27x150; T30x150; T40x150; T45x200 e T50x200





H10MT

Chave dupla de punho torx tamperproof

Ref.	Medida	Preço
H10MT10100	T10x100	2.60€
H10MT15100	T15x100	2.65€
H10MT20100	T20x100	2.70€
H10MT25100	T25x100	2.85€
H10MT27150	T27x150	3.00€
H10MT30150	T30x150	3.10€
H10MT40150	T40x150	3.80€
H10MT45200	T45x200	5.30€
H10MT50200	T50x200	5.70€

H12S

Chaves torx extra longa

Ref.	Medida	L1 (mm)	L2 (mm)	Preço
H12S09085	T9	85	5	1.10€
H12S10090	T10	90	5,5	1.10€
H12S15100	T15	100	8	1.20€
H12S20115	T20	115	12,5	1.30€
H12S25130	T25	130	18	1.40€
H12S27145	T27	145	24,5	1.60€
H12S30165	T30	165	40	1.90€
H12S40185	T40	185	62	2.30€
H12S45205	T45	205	98	2.60€
H12S50230	T50	230	128	3.50€

H20MT

Chaves torx dupla de punho

Ref.	Medida	L1 (mm)	L2 (mm)	Preço
H20MT10	T10	110	15	2.85€
H20MT15	T15	120	15	2.90€
H20MT20	T20	125	16	3.35€
H20MT25	T25	135	16	3.55€
H20MT27	T27	145	16	3.70€
H20MT30	T30	155	16	4.10€
H20MT40	T40	165	16	4.60€
H20MT45	T45	185	16	5.40€
H20MT50	T50	205	20	6.30€



Chaves

H12S110S

18.80€

Jogo de 10 chaves torx longas

Composição/ medidas (mm):
Chaves: T9; T10;
T15; T20; T25; T27;
T30; T40; T45 e T50



H15M105S

14.00€

Jogo de 5 chaves estriadas em "L"

Composição/ medidas (mm):
Chaves: M5; M6; M8; M10 e M12



H20MB1037S



53.50€

Jogo de 9 chaves hexagonais de ponta esférica com punho e 28 bits

Composição/ medidas (mm):

H20MB Chaves: H1,5X100; H2X100; H2,5X110; H3X120; H4X125; H5X155; H6X165; H8X185 e H10X210
 Bits phillips: PH1; PH2 e PH3
 Bits pozi: PZ1; PZ2 e PZ3
 Bits torx: T10; T15; T20; T25; T27; T30; T35 e T40
 Bits fenda: 3; 4; 5; 6 e 7
 Bits estriados: M4; M5 e M6
 Bits quadrados: 1; 2 e 3
 Bits spanner: 4 e 6



H20MT09S



49.00€

Jogo de 9 chaves torx duplas de punho

Composição/ medidas (mm):

Chaves: T10x110; T15x120; T20x125; T25x135; T27x145; T30x155; T40x165; T45x185 e T50x205

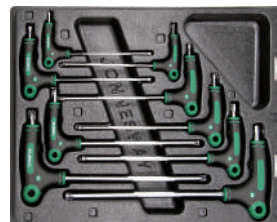

H22S109S



18.00€

Jogo de 9 chaves hexagonais extra longas estriadas Especial para remover parafusos danificados

Composição/ medidas (mm):

Chaves: 1,5; 2; 2,5; 3; 4; 5; 6; 8 e 10

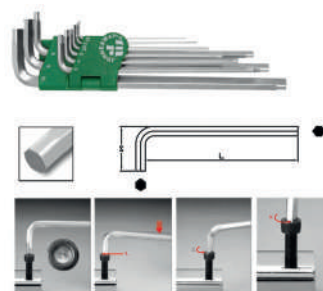

JR72

TOYOTA CAETANO
MOTORSPORT

M03025 26.50€
Marreta metálica

Peso: 1 330g

M040
Martelo com batente redondo e pena esférica

Ref.	Peso (g)	Compr. (mm)	Preço
M04008	395	278	11.20€
M04012	527	283	12.00€
M04016	780	327	14.00€
M04024	1 063	383	18.60€
M04032	1 208	385	20.00€

M010
Martelo de orelhas em aço

Ref.	Peso (g)	Compr. (mm)	Preço
M01016	777	320	26.00€
M01020	875	350	28.00€

M05020 16.80€
Martelo de orelhas

Peso: 830g

Comprimento: 330mm

M060
Marreta

Ref.	Peso (g)	Compr. (mm)	Preço
M06030	1 550	263	18.80€
M06040	2 250	276	21.50€

M07016 16.90€
Martelo de batentes plásticos

Peso: 840g

Comprimento: 314mm

M07016-ACE 2.75€

Batente amarelo de substituição M07016

M07016-TPR 1.50€

Batente preto de substituição M07016

Martelos
M29
Martelo de batentes plásticos intermutáveis

Ref.	Diâmetro (mm)	Compr. (mm)	Preço
M2927	27	270	19.00€
M2932	32	290	22.00€
M2940	40	330	32.50€
M2950	50	350	46.00€
M2960	60	380	67.00€

M2927
Batentes para martelo M2927

Ref.	Cor	Preço
M2927-T1	branco	2.20€
M2927-T2	amarelo	3.50€

M2932
Batentes para martelo M2932

Ref.	Cor	Preço
M2932-T1	branco	2.80€
M2932-T2	amarelo	3.50€

M2940
Batentes para martelo M2940

Ref.	Cor	Preço
M2940-T1	branco	3.60€
M2940-T2	amarelo	5.40€

M2950
Batentes para martelo M2950

Ref.	Cor	Preço
M2950-T1	branco	5.30€
M2950-T2	amarelo	8.00€

M09
Martelo de mecânico tipo "alemão"

Ref.	Peso (g)	Compr. (mm)	Preço
M09100	100	260	7.60€
M09200	200	280	8.40€
M09300	300	300	10.00€
M09500	500	320	12.20€
M09800	800	350	16.30€
M091000	1 000	360	20.00€

M110
Martelo anti recuo revestido a borracha

Ref.	Peso (g)	Compr. (mm)	Preço
M11035	400	260	14.50€
M11045	520	286	18.00€
M11065	1500	370	29.90€

M601

Punção de bico



Ref.	D (mm)	D1 (mm)	L (mm)	Preço
M60103	3	9,5	120	1.80€
M60104	4	9,5	120	2.10€
M60105	5	12	120	2.70€

M611

Talhadeira



Ref.	D (mm)	D1 (mm)	L (mm)	Preço
M61110	10	9,5	150	2.20€
M61112	12	9,5	130	2.20€
M61113	13	9,5	150	2.30€
M61116	16	12,7	180	3.20€
M61119	19	15,8	180	4.45€
M61122	22	15,8	200	4.75€
M61125	25	19	200	7.10€

M621

Punção



Ref.	D (mm)	D1 (mm)	L (mm)	Preço
M62102	2	9,5	120	1.60€
M62103	3	9,5	120	1.70€
M62104	4	9,5	120	1.60€
M62105	5	9,5	120	1.70€
M62106	6	9,5	120	1.60€
M62108	8	9,5	120	1.90€

M631

Saca troços



Ref.	D (mm)	D1 (mm)	L (mm)	Preço
M63102	2	8	115	1.95€
M63103	3	8	125	2.00€
M63104	4	9,5	150	2.25€
M63105	5	9,5	165	2.55€
M63106	6	12,7	180	3.05€
M63108	8	12,7	180	3.15€

M641

Butil



Ref.	D (mm)	D1 (mm)	L (mm)	Preço
M64105	5	9,5	130	2.85€

M63106S

15.00€

Jogo de 6 saca troços

Composição/ medidas (mm):

 2x8x115; 3x8x125;
 4x9,5x150; 5x9,5x165;
 6x12,7x180 e 8x12,7x180

M63M106S

16.80€

Jogo de 6 saca troços cromados

Composição/ medidas (mm):

 2x8x115; 3x8x125; 4x9,5x150;
 5x9,5x165; 6x12,7x180 e 8x12,7x180

M64105S

11.30€

Jogo de 5 punções e escopros

Composição/ medidas (mm):

 Punção: 2x8x115; 3x8x125;
 4x9,5x150; 5x9,5x165; 6x12,7x180
 Escopro: 8x12,7x180

M64M105S

11.20€

Jogo de 5 punções e escopros cromados

Composição/ medidas (mm):

 Punção: 3x 9,5x120
 Punção bico: 2x9,5x120
 Talhadeira: 12x9,5x130
 Saca troços: 4x9,5x150
 Escopro: 5x9,5x130

M61H1
Escopro com punho de proteção

Ref.	Medida (mm)	Compr. (mm)	Preço
M61H116	16	170	4.80€
M61H119	19	190	6.20€
M61H124	24	220	9.50€

M62H1
Punção com punho de proteção

Ref.	Medida (mm)	Compr. (mm)	Preço
M62H102	2	185	4.40€
M62H103	3	185	4.50€
M62H104	4	185	4.60€
M62H106	6	185	4.70€

Diversos
M63H1
Saca troços com punho de proteção

Ref.	Medida (mm)	Compr. (mm)	Preço
M63H103	3	150	3.50€
M63H105	5	200	4.50€
M63H106	6	210	5.70€
M63H108	8	220	6.30€

AI030045

99.90€

Jogo de 4 cinzéis com proteção

MF05
Limas

Ref.	Tipo	Medida (mm)	Preço
MF05A	chata	200	7.70€
MF05B	redonda	200	6.50€
MF05C	meia cana	200	8.10€
MF05D	quadrada	200	7.50€
MF05E	triangular	200	7.50€

MF05S

44.70€

Jogo de 5 limas de 200mm

Composição:

 MF05A Lima chata
 MF05B Lima redonda
 MF05C Lima meia cana
 MF05D Lima quadrada
 MF05E Lima triangular

MF06S

23.00€

Jogo de 6 mini limas de 100mm

Composição:

 Mini lima redonda
 Mini lima triangular
 Mini lima quadrada
 Mini lima meia cana
 Mini lima plana
 Mini lima plana em bico

MHS100AG

16.90€

Serra



P9601

10.90€

Navalha corta cabos



MK2040

9.10€

X-ato com lâmina retrátil
Com 2 lâminas de substituição



MK2040-B

1.35€

Lâmina para x-ato MK2040 - 5 unidades

MK2080

10.00€

X-ato
Botão de segurança lâmina
Inclui 4 lâminas 18x100mm



MKS27

19.70€

Jogo de x-ato

Composição:
X-ato
Raspador
Acessórios



MKS27

Lâmina raspador - 100 unidades

Ref.	Tipo	Medida (mm)	Preço
MKS27-12	A	12	18.30€
MKS27-16	B	16	18.30€
MKS27-16A	C	(53°) 16	21.80€
MKS27-20	D	20	18.20€

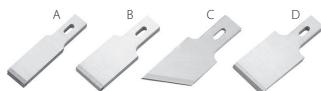

MT0701

3.60€

Fita métrica
Corpo em plástico ABS resistente ao choque
Comprimento: 3m



MT0702

4.60€

Fita métrica
Corpo em plástico ABS resistente ao choque
Comprimento: 5m



MT0703

8.00€

Fita métrica
Corpo em plástico ABS resistente ao choque
Comprimento: 8m



MTC1

Paquímetro leitura vigésimal

Ref.	Compr. (mm)	Preço
MTC1150	150	38.00€
MTC1200	200	57.00€
MTC1300	300	95.00€



MTC153

14.20€

Esquadro metálico
Dimensões: 300x40x1 mm



MTC156

2.60€

Régua metálica
Dimensões: 334x23,7x1 mm



MTC200

96.00€

Paquímetro digital
Comprimento: 200mm



MTC3

Compasso de precisão pontas direitas

Ref.	Compr. (mm)	Preço
MTC306	150	15.80€
MTC308	200	17.80€

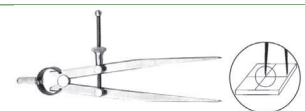

MTC408

17.50€

Compasso de precisão pontas curvas para exteriores

Comprimento: 200mm

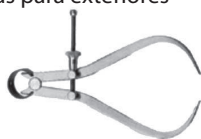

MTC508

17.30€

Compasso de precisão pontas curvas para interiores

Comprimento: 200mm



MTM1

Micrómetro exteriores

Ref.	Medida (mm)	Preço
MTM1025	0-25	31.50€
MTM1050	25-50	36.00€
MTM1075	50-75	40.90€
MTM1100	75-100	47.50€

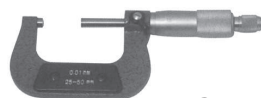

AG010207

75.00€

Gambiarras de Leds

Inclui: Carregador 220v AC/ 5v DC e cabo USB

Dimensões: 375x30x30mm Potência: 15W
 Carregador: 220v/ 50Hz Capacidade da bateria: 2,5 a 10h
 Fluxo luminoso: 410 lumen Tempo de carga: 3,5 a 4h
 Iluminância máxima: 935 lux projetada a 50cm
 Bateria recarregável: Li-ion 3,7v 2 200mAh



AG010224

68.00€

Gambiarras flexíveis de Leds

Comprimento: 168mm Bateria: Li-ion 3,7v - 2.2Ah
 Carregador: AC/DC Haste flexível 360°
 Base magnética Regulador de intensidade
 Autonomia: 2 a 8h (variável conforme intensidade)



C-DM1

22.00€

Barra magnética

Dimensões: 475x52x17mm



DV13P

Chave phillips isolada (1000 Volts)



Ref.	Medida	L1 (mm)	L2 (mm)	L (mm)	Preço
DV13P060	PH0	60	98	158	3.20€
DV13P180	PH1	80	104	184	4.10€
DV13P2100	PH2	100	110	210	4.50€
DV13P3150	PH3	150	120	270	5.50€

DV13S

Chave fenda isolada (1000 Volts)

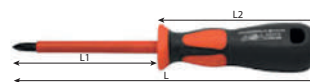

Ref.	Medida (mm)	L1 (mm)	L2 (mm)	L (mm)	Preço
DV13S275	2,5	75	98	173	3.30€
DV13S3100	3x100	100	80	180	3.60€
DV13S4100	4	100	98	198	3.70€
DV13S5125	5,5	125	104	229	4.30€
DV13S6150	6,5	150	110	260	5.00€
DV13S8175	8x175	175	120	295	6.00€

DV13Z

Chave pozi isolada (1000 Volts)



Ref.	Medida (mm)	L1 (mm)	L2 (mm)	L (mm)	Preço
DV13Z060	PZ0x60	60	98	158	3.50€
DV13Z180	PZ1x80	80	104	184	4.20€
DV13Z2100	PZ2x100	100	110	210	4.70€
DV13Z3150	PZ3x150	150	120	270	6.00€

DV13PP07S

33.50€

Jogo de chaves isoladas fenda/ phillips (1000 Volts)

Composição/ medidas (mm):

- Chaves fenda: 4x100; 5,5x125 e 6,5x150
- Chaves phillips: PH0x60; PH1x80 e PH2x100
- Busca-polos



DV41M

Chaves de caixa isoladas com punho (1000 Volts)



Ref.	Medida	Compr. (mm)	Preço
DV41M5	M5	125	6.10€
DV41M6	M6	125	6.30€
DV41M7	M7	125	6.30€
DV41M8	M8	125	6.40€
DV41M10	M10	125	6.50€
DV41M13	M13	125	6.90€

DV4118SV

148.00€

Tabuleiro EVA com ferramentas isoladas (1000 volts)

Composição:

Ref.	Chave	Medida (mm)
DV13S275	fenda	2,5x75
DV13S3100	fenda	3x100
DV13S4100	fenda	4x100
DV13S5125	fenda	5,5x125
DV13P060	phillips	PH0x60
DV13P180	phillips	PH1x80
DV13P2100	phillips	PH2x100
DV13P3150	phillips	PH3x150
DV41M	caixa punho	M4x125; M5x125; M5,5x125; M6x125; M7x125; M8x125; M9x125; M10x125; M11x125 e M12x125

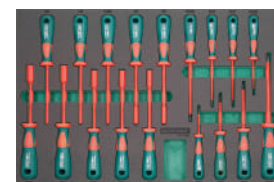

DV41M06S 40.00€

Jogo de 6 chaves de caixa isoladas com punho (1000 Volts)

Composição/ medidas:

Chaves caixa: M5; M6; M7; M8; M10 e M13

MKV7 10.00€

X-ato isolado 1000V

Comprimento: 180mm

Lâmina: 50mm

MKV7-K 14.00€

Lâmina para x-ato isolado 1000 volts - 4 unidades

MKV8 16.30€

Navalha isolada 1000V

Comprimento: 180 mm

Lâmina: 50mm

PV0118 21.20€

Alicate universal

Cumpra a norma IEC 60900

Compr. (mm)	4.0	3.0	2.0	1.6
200				

PV08 16.00€

Alicate universal isolado (1000 volts)

Cumpra a norma IEC 60900

Ref.	Compr. (mm)	4.0	3.0	2.0	1.6	Preço
PV0816	160					16.00€
PV0817	180					17.50€

PV0518 23.50€

Alicate corta cabos (trabalho intensivo)

Cumpra a norma IEC 60900

Comprimento: 200mm

Capacidade de corte: Ø13/60mm

PV0918 21.00€

Alicate de corte

Cumpra a norma IEC 60900

Compr. (mm)	4.0	3.0	2.0	1.6
200				

PV1016 17.50€

Alicate de corte diagonal

Cumpra a norma IEC 60900

Compr. (mm)	4.0	3.0	2.0	1.6
160				

PV1116 17.00€

Alicate de pontas redondas isolado (1000 volts)

Cumpra a norma IEC 60900

Comprimento: 160mm

PV1118 17.50€

Alicate de pontas

Cumpra a norma IEC 60900

Compr. (mm)	4.0	3.0	2.0	1.6
200				

PV1218 20.20€

Alicate de pontas redondas

Cumpra a norma IEC 60900

Compr. (mm)	4.0	3.0	2.0	1.6
200				

PV1416 16.00€

Alicate de pontas chatas

Cumpra a norma IEC 60900

Comprimento: 160mm

PV1516 15.70€

Alicate de descarnar fios (trabalho intensivo)

Cumpra a norma IEC 60900

Comprimento: 160mm

PV28110 24.00€

Alicate ajustável

Cumpra a norma IEC 60900

Comprimento: 275mm



PV4006

19.40€

Alicate de pontas redondas

Cumpra a norma IEC 60900

Comprimento: 200mm



PSV108SP

84.00€

Jogo de 3 alicates e 5 chaves isoladas 1 000V

Composição/ medidas em mm:

PV087 Alicate universal

PV1108 Alicate universal de pontas

PV106 Alicate de corte 5,5x125

DV1SPP-TP Busca-polos 220-250v

DV13S5125 Chave fenda 5,5x125

DV13S6150 Chave fenda 6,5x150

DV13P180 Chave phillips P1x80

DV13P2100 Chave phillips P2x100

B

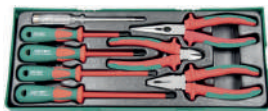

PSV110SC

140.00€

Jogo de 10 ferramentas isoladas 1 000V

Composição:

4 Alicates

4 Chaves de fenda/ phillips

1 Navalha

1 Busca-polos

C



S03V21

Chaves de caixa 1/4" com isolamento a 1 000V



Ref.	Medida (mm)	Compr. (mm)	Preço
S03V2106	6	41	4.50€
S03V2108	8	41	4.70€
S03V2110	10	41	4.90€
S03V2114	14	41	5.20€



S03V31

Chaves de caixa 3/8" com isolamento a 1 000V



Ref.	Medida (mm)	Compr. (mm)	Preço
S03V3108	8	44,5	6.50€
S03V3110	10	44,5	6.60€
S03V3112	12	44,5	7.00€
S03V3113	13	44,5	7.20€
S03V3114	14	44,5	7.40€
S03V3117	17	44,5	7.90€
S03V3119	19	46	8.20€
S03V3122	22	46	9.00€

S03V41

Chaves de caixa 1/2" com isolamento a 1 000V



Ref.	Medida (mm)	Compr. (mm)	Preço
S03V4110	10	55	8.00€
S03V4111	11	55	8.30€
S03V4112	12	55	8.50€
S03V4113	13	55	8.60€
S03V4114	14	55	9.00€
S03V4117	17	55	9.10€
S03V4119	19	57	9.20€
S03V4122	22	57	10.00€
S03V4124	24	57	10.30€
S03V4127	27	59	12.00€
S03V4132	32	59	15.00€

S03V3116SC

230.00€

Jogo de 16 peças 3/8" com roquete isolado a 1 000V

Composição/ medidas em mm:

RV033 Roquete isolado 200

S43V38 Cabo "T" 200

S25V36 Extensão 150

S25V310 Extensão 250

S03V3 Chaves de caixa: 8; 10; 12; 13; 14; 17; 19 e 22

S09V3 Bits: 4; 5; 6 e 8

B



S03V3136SV
412.00€
Tabuleiro EVA com ferramentas de 1/4" e 3/8" isoladas a 1 000V

Composição/ medidas em mm:

RV032	Roquete de 1/4"
RV033	Roquete de 3/8"
S43V28	Cabo "T" de 1/4" de 125
S43V38	Cabo "T" de 3/8" de 200
S25V24	Extensão de 1/4" de 100
S25V3	Extensão de 3/8" de 150 e 250
S03V21	10 Chaves de caixa: 5 a 14
S03V31	11 Chaves de caixa: 8 a 22
S09V2H	4 Bits de caixa de 1/4" de 60
S09V3H	4 Bits de caixa de 3/8" de 60

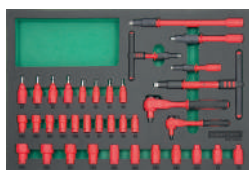
S03V4120SC
320.00€
Jogo de 20 peças 1/2" com roquete isolado a 1 000V

Composição/ medidas em mm:

RV034	Roquete isolado 250
S43V48	Cabo "T" 200
S25V45	Extensão 125
S25V410	Extensão 250
S03V4	Chaves de caixa: 10; 11; 12; 13; 14; 17; 19; 22; 24; 27 e 32
S09V4	Bits: 4; 5; 6; 8 e 10

S03V4124SV
370.00€
Tabuleiro EVA com ferramentas de 1/4" e 3/8" isoladas a 1 000V

Composição/ medidas em mm:

RV034	Roquete de 1/2"
S43V48	Cabo "T" de 1/2" de 200
S25V4	Extensão de 125 e 250
S03V41	13 Chaves de caixa: 10 a 32
S09V41H	5 Bits de caixa de 200
WV27AS8	Chave inglesa de 150
MKV7	X-acto

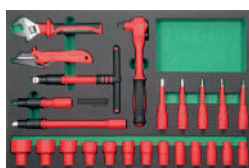
S09V3H

Chaves de caixa hexagonal 3/8" com isolamento a 1 000V

Ref.	Medida (mm)	Compr. (mm)	Preço
S09V3H4	4	60	6.50€
S09V3H5	5	60	6.70€
S09V3H6	6	60	7.00€
S09V3H8	8	60	7.80€

S09V41H

Chaves de caixa 3/8" com isolamento a 1 000V

Ref.	Medida (mm)	Compr. (mm)	Preço
S09V41H4	4	120	9.00€
S09V41H5	5	120	9.20€
S09V41H6	6	120	9.50€
S09V41H8	8	120	9.80€
S09V41H10	10	120	10.50€

S25V3

Extensão 3/8" com isolamento a 1 000V

Ref.	Compr. (mm)	Peso (g)	Preço
S25V36	150	150	23.00€
S25V310	250	250	28.00€

S25V4

Extensão 1/2" com isolamento a 1 000V

Ref.	Compr. (mm)	Peso (g)	Preço
S25V45	150	210	27.00€
S25V410	250	410	29.00€

S43V

Cabo "T" com isolamento a 1 000V



Ref.	Quadra	Compr. (mm)	Peso (g)	Preço
S43V38	3/8"	200	240	34.00€
S43V48	1/2"	250	330	37.00€

RV03

Roquete com isolamento a 1 000V



Ref.	Quadra	Compr. (mm)	Peso (g)	Preço
RV032	1/4"	150	140	37.00€
RV033	3/8"	200	300	48.50€
RV034	1/2"	250	570	55.00€

W23V1

Chaves luneta com isolamento a 1 000V



Ref.	Medida (mm)	Compr. (mm)	Preço
W23V108	8	164	16.20€
W23V110	10	174	17.00€
W23V111	11	184	17.80€
W23V112	12	184	18.00€
W23V113	13	205	19.00€
W23V114	14	205	19.50€
W23V116	16	221	22.00€
W23V117	17	221	22.50€
W23V118	18	237	24.50€
W23V119	19	237	25.00€
W23V121	21	257	27.50€
W23V122	22	257	28.00€
W23V124	24	287	32.50€

W25V1

Chaves de boca 3/8" com isolamento a 1 000V



Ref.	Medida (mm)	Compr. (mm)	Preço
W25V108	8	104	12.00€
W25V109	9	104	12.50€
W25V110	10	114	13.00€
W25V113	13	154	14.00€
W25V114	14	154	14.50€
W25V117	17	170	15.50€
W25V118	18	180	17.00€
W25V119	19	180	17.50€
W25V121	21	202	21.50€
W25V122	22	202	22.00€
W25V124	24	237	23.00€

W25V1125SV

495.00€

Tabuleiro EVA com ferramentas isoladas a 1 000V

Composição/ medidas em mm:

- W23V11 9 Chaves luneta 10 a 19mm
- W25V 13 Chaves bocas 7 a 24mm
- PV0818 Alicates universal 200mm
- PV1016 Alicates de corte 160mm
- PV1116 Alicates de pontas 160mm

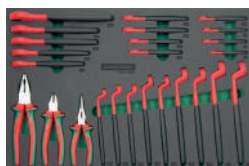

WV27AS10

46.50€

Chave ajustável isolada 1000V

Abertura: 33mm
Comprimento: 200mm





JONNESWAY[®]

Ferramenta Especial
Mecânica



Mecânica



Pesados



Motociclos



Acessórios



Chapeiro

Ferramenta específica - ramo automóvel

AB030056

35.20€

Insuflador de ar para abertura de portas

Comprimento: 230mm



AB030061

21.20€

Ferramenta para retirar braço do limpa parabrisas



AE040020

58.00€

Cilindro hidráulico

Comprimento: 140mm fechado | 215mm estendido

Capacidade: 2t



AE150005

99.00€

Par de preguiças de 3t com apoio em borracha

Altura máxima: 440mm

Altura mínima: 290mm



AE300064

208.00€

Kit teste de pressão para radiadores com 17 peças

Composição:

AE30064-02 Audi A4, A5, A6

AE30064-03 Opel, Ford, VW

AE30064-04 BMW

AE30064-05 BMW

AE30064-06 Volvo, Citroën, Renault, Fiat, Peugeot

AE30064-07 Audi, VW

AE30064-08 Sede ajustável

AE30064-09 Pino união 50mm

AE30064-10 Pino união 35mm

AE30064-11 Pino união 27mm

AE30064-12 Adaptador para 8; 9 e 11

AE30064-13 Adaptador

AE30064-14 Fixador

AE30064-15 Honda, Toyota

AE30064-16 Mitsubishi, Honda, Ford, Nissan, Mazda



AE3000

Adaptadores para teste radiadores

Ref.

Preço

AE300064-02

18.30€

AE300064-03

18.30€

AE300064-04

18.30€

AE300064-05

18.30€

AE300064-06

14.70€

AE300064-07

14.70€

AE300064-15

22.00€

AE300064-16

22.00€



AE300100-040

20.50€

Adaptador para kit de pressão de radiadores - Ford

Aplicável no kit AE300064



AE300100-042

20.50€

Adaptador para kit de pressão de radiadores - Ford

Aplicável no kit AE300064



AE300100-060

22.00€

Adaptador para kit de pressão de radiadores - Mercedes

Aplicável no kit AE300064



AE300103

15.90€

Aparadeira de chão para óleo

Dimensões: 600x450x180mm

Capacidade: 16l



AE300152

173.50€

Kit teste de pressão do radiador com 5 peças



AE300173

18.00€

Sangrador de fluido de embraiagem e travões
Fácil, rápido e eficiente utilizando o ar dos pneus



AE300176-A

49.00€

3 Adaptadores especiais para VW/ Audi/ Mercedes



AE300212

107.00€

Distribuidor de óleo de transmissões

Dimensões: 240x200x440mm
Capacidade: 4l
Peso: 1 600g
Bomba manual e 4 adaptadores



AE310002

237.00€

Conjunto de saca hidráulico com acessórios
Capacidade: 90-145mm



AE310006

89.00€

Conjunto de 2 extratores
Capacidade: 30-75mm



AE3100

Separadores meia lua

Ref.	Medida (mm)	Preço
AE310024	30-50	18.50€
AE310025	50-75	27.00€
AE310026	75-105	43.00€
AE310027	105-150	97.00€



AE310008

147.00€

Extrator interior e exterior

Capacidade: 15-30 e 30-80mm interna
15-80mm externa

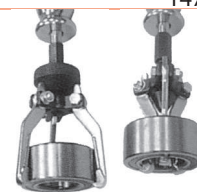

AE310010A

104.00€

Jogo de extrator semieixo



AE310013

80.00€

Extrator universal de cubo roda

Capacidade: 90-140 e 130-180mm



AE310014

155.00€

Extrator de cubo roda e semieixo

Capacidade: 90-140 e 130-180mm

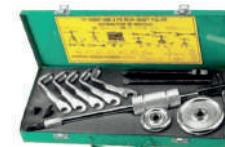

AE310016

45.50€

Extrator semieixo



AN010045

8.40€

Separador de rótulas



AE3100

Saca de 3 pernas

Ref.	Tamanho	Abertura (mm)	Capacidade (t)
------	---------	---------------	----------------

AE310034	3"	40-76	2
----------	----	-------	---

AE310035	4"	50-102	5
----------	----	--------	---

AE310037	8"	80-203	12
----------	----	--------	----

AE310038	12"	120-305	18
----------	-----	---------	----

41.50€

AE310023

Extrator de rótulas



Preço

17.50€

25.00€

93.00€

210.00€

AE310062

54.50€

Saca rolamentos longo

Comprimento: 300mm

Capacidade: 10-50mm



AE310063

65.00€

Saca para pequenos rolamentos

Especialmente indicado para remoção de pequenos rolamentos na área automóvel, reparação de equipamentos industriais e domésticos

Capacidade: 1t

Abertura: 19 a 45mm

Profundidade alcance: 73mm



AE310087

73.50€

Extrator universal de rótulas

Especialmente concebido para situações de utilização em espaço reduzido

Aplicável: Audi, VW, BMW, Ford, Mercedes

(W170, W202, W210, W220), Opel, Mitsubishi ...



AE310099

107.00€

Extrator 7" de 2 ou 3 pernas para interiores e exteriores

Capacidade: 20t

Abertura: 76-178mm



Alterável para:



AE310066

23.50€

Extrator para volantes de direção

Aplicável: Opel, Ford entre outros



AE310122

83.50€

Extrator de rótulas

Abertura: 32mm



AE310073

27.00€

Extrator de rótulas

Abertura: 20mm



AE310150

66.00€

Saca polies



AE310077

31.80€

Extrator de rótulas

Abertura: 20mm

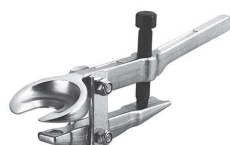

AE3101
Extrator de rótulas

Ref.	Ø (mm)	Largura (mm)	Altura (mm)	Preço
AE310109A	18	40	35	18.00€
AE310110	23	50	45	37.70€
AE310112	40	80	80	73.00€

AE3101
Saca de 2 braços

Ref.	Ajuste Int. (mm)	Ajuste Ext. (mm)	Altura (mm)	Preço
AE310146B	25-80	70-130	100	45.90€
AE310146D	50-160	105-220	150	79.50€
AE310146E	60-200	120-270	150	107.00€
AE310146G	80-350	160-420	200	275.00€
AE310146H	110-520	195-600	200	400.00€

AE310172
Jogo de sacas

Composição:

Saca de 2ton

Pernas curtas: 85mm

Pernas compridas: 185mm

Saca de 6ton

Pernas curtas: 140mm

Pernas compridas: 280mm

Cilindro de 30ton

734.00€

AE310180
Jogo de saca rótulas com acessórios ajustáveis

Abertura: 20; 22; 24; 27 e 30mm



250.00€

AE310183
Removedor da barra de direção

105.00€

AE320023
Compressor de molas para amortecedores

Abertura: 270mm



35.50€

AE320034
Jogo de extrator de molas MacPherson

464.50€

AE320035
Torno para fixação MacPherson

140.00€

AE320044
Compressor de molas para amortecedores

Abertura: 300mm



60.00€

AE300154B

102.00€

Refratómetro

Aparelho apto para testar líquido de baterias, líquido refrigerante e AdBlue

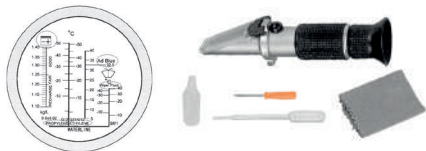

AE300168

95.00€

Verificador de fugas da cabeça do cilindro

Equipamento destinado a verificar fugas na combustão.

A utilização de líquido contrastante permite verificar a existência de dióxido de carbono no depósito do líquido de refrigeração, denunciando assim a existência de fugas na combustão.



AE300168-1

35.00€

Líquido para verificador da cabeça do cilindro

Embalagem de 250ml

AE300201

108.00€

Pistola tornado vaporizadora

Dimensões: 330x105x270mm

Capacidade copo: 1l

Peso: 780g

Ruído: 85dB

Alimentação: 6,2bar

Consumo de ar: 56,6l/min

Entrada de ar: 1/4"



AE300202

105.00€

Pistola tornado vaporizadora/ espuma

Dimensões: 330x105x260mm

Capacidade copo: 1l

Peso: 950g

Ruído: 70dB

Alimentação: 6,2bar

Entrada de ar: 1/4"

Consumo de ar: 56,6l/min



AE300204

20.00€

Seringa para fluidos

Fabricado em plástico resistente a fluido travões e anticongelante. Permite sucção, adição e visualização do fluido

Capacidade: 200cc

Peso: 294g

NÃO utilizar com combustíveis



AE300205

46.00€

Seringa para fluidos

Fabricado em plástico resistente a fluido travões e anticongelante. Permite sucção, adição e visualização do fluido

Capacidade: 1,5l

Peso: 900g

Aplicação: óleo da caixa velocidades e diferenciais

NÃO utilizar com combustíveis



AE300211

79.60€

Seringa para fluidos com 5 adaptadores

Fabricado em plástico resistente e aplicável a todos os tipos de óleos e combustíveis. Permite sucção, adição e visualização do fluido.

Capacidade: 1,5l



AE300206

13.70€

Base de recolha de óleos para latas 20/ 30l

Concebido para recolha de restos de óleo de filtros, novo ou usado, e outros recipientes (encaixe direto em latas de 20/ 30l)

Fabricado em polietileno resistente de alta densidade

Capacidade: 3l

Peso: 500g

Diâmetro: 350mm



AE300207

43.00€

Base de recolha de óleos para bidons 200l

Concebido para recolha de restos de óleo de filtros, novo ou usado, e outros recipientes (encaixe direto no topo de bidons de 200l)

Fabricado em polietileno resistente de alta densidade

Capacidade: 20l

Peso: 1 700g

Diâmetro: 600mm



AE300215

33.70€

Pistola de limpeza de motores

Bico ajustável

Capacidade: 1l

Consumo de ar: 160 l/m

Entrada de ar: 1/4"

Pressão de trabalho: 5-8 Bar



AE300220

68.00€

Escorredor de resíduos de óleo
Dimensões: 174x197x486mm
Capacidade: 2l



AG010034

5.80€

Caneta magnética
Comprimento: 580mm



AG010035

18.90€

Pesca magnético com luz e espelho



AG010163A

7.70€

Pesca magnético flexível



AG010164

35.00€

Kit de pesca magnético com luz e espelho
Luz: branca, azul e UV



AG010046

7.70€

Ponteira para válvulas dos pneus
Comprimento: 230mm



AG010159

5.00€

Ponteira para mangueira de ar dos pneus



AG010059

27.00€

Jogo de 4 saca casquilhos
Medidas: 6; 8; 10 e 12mm



AG010059

Saca casquilhos

Ref.	Medida (mm)	Preço
AG010059-6	6	5.80€
AG010059-8	8	5.80€
AG010059-10	10	6.30€
AG010059-12	12	6.30€

AG010036

7.50€

Bandeja magnética redonda
Dimensões: Ø 150mm



AG010111

23.50€

Bandeja magnética retangular
Dimensões: 240x140mm



AS-0065

32.00€

Suporte magnético para máquina de impacto e 4 chaves



AG010049

8.20€

Jogo de 5 saca pernos



AG010089

15.00€

Medidor digital de pressão de ar

Baterias de lítio
Visor LCD
Auto calibração
Auto off



AG010099

27.50€

Chaves de cruz para porcas de rodas

Medidas: 17; 19 e 21mm



AG010225

24.00€

Chave de rodas com 3 peças

Pode ser utilizado em + ou em "T"

Medidas: 17; 19 e 21mm

Tubo perfurado 355mm com chave de 19 e 21mm
Tubo perfurado 395mm com chave de 17mm
Adaptador 1/2"



AG010109

16.50€

Quebra porcas

Medidas: 12-18 e 16-22mm



AG010118A

21.20€

Medidor angular de torque 1/2"



AG010147

11.50€

Chave de aperto angular de torque 1/2"



AG010208

53.00€

Jogo de extratores de parafusos torx danificados com 8 peças

Composição:

Medida (mm)	Compr. (mm)	Hex (mm)
3	38	10
4	38	10
5	38	10
6	38	10
7	38	12
8	38	12
10	38	14
12	38	14



AG10001SP-G

3.50€

Medidor de passo de rosca



AG010227

265.00€

Jogo de machos e caçonetos com 53 peças

Composição:

- 15 Machos 38mm: M6x0,75; M6x1,0; M8x1,0; M8x1,25; M10x1,25; M10x1,5; M12x1,25; M12x1,5; M12x1,75; M14x1,5; M14x2,0; M16x1,5; M16x2,0; M18x1,5 e M18x2,5
- 6 Machos 50mm: M20x1,5; M20x1,5; M22x1,6; M22x2,5; M24x1,5 e M24x3,0
- 21 Caçonetos: M6x0,75; M6x1,0; M8x1,0; M8x1,25; M10x1,25; M10x1,5; M12x1,25; M12x1,5; M12x1,75; M14x1,5; M14x2,0; M16x1,5; M16x2,0; M18x1,5; M18x2,5; M20x1,5; M20x2,5; M22x1,5; M22x2,5; M24x1,5 e M24x3,0

- 5 Extratores
- 1 Porta caçonetos
- 1 Desandador de machos (M6 - M25)
- 1 Desandador de machos (M4 - M12)
- 1 Chave phillips PH2 38mm
- 2 Adaptadores de Ø 50mm



AG010229

132.00€

Jogo de machos e caçonetos com 50 peças

Composição:

- 22 Machos + 22 Caçonetos: M3x0,5; M3x0,6; M4x0,7; M4x0,75; M5x0,8; M5x0,9; M6x0,75; M6x1,0; M7x0,75; M7x1,0; M8x1,0; M8x1,25; M9x1,0; M9x1,25; M10x1,0; M10x1,25; M10x1,5; M11x1,5; M12x1,25; M12x1,5; M12x1,75 e 1/8NPT27

- 1 Desandador de machos M6 - M12
- 1 Desandador em "T" para machos
- 1 Porta caçonetos
- 1 Chave phillips
- 1 Medidor passo rosca
- 1 Punção



AG10001SP-T

2.70€

Desandador em T para machos



AG10001SP-W
7.70€
Desandador macho extensível

Medidas: M4 a M12

AG10002SC-W
5.10€
Desandador macho extensível

Medidas: M3 a M12

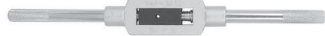
AH020002
20.40€
Proteção de guarda-lamas com fixação magnética

Dimensões: 1 050x650mm

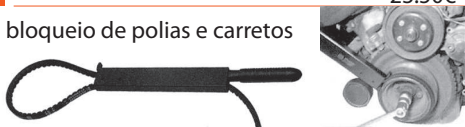

AI010006
23.50€
Ferramenta para bloqueio de polias e carretos

AI010009
22.00€
Ferramenta para limpeza das ranhuras de segmentos

Com 3 lâminas circulares para limpeza de pistões (diâmetro: 51 a 127mm)

Lâmina 1: 1/16"; 5/64"; 3/32"; 1/8"; 5/32" e 3/16"

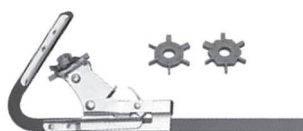
Lâmina 2: 2; 2,5; 3; 4; 4,5mm e 1/4"

Lâmina 3: 1,2; 1,5; 1,8; 2,8; 5 e 5,5mm

AI010023
11.80€
Esticador de correias

AI010029
67.50€
Saca carretos e polias

AI010030
79.00€
Chave bloqueio da polie da árvore de cames

AI010037
84.00€
Kit comando de motores com 8 peças

Composição:

Marca	Modelo	Aplicação
OPEL	Astra	G 1.7 TD; 2.0 16V
	Vectra	1.8; 2.0 16V >1995



OPEL	Astra	G 1.4 ; 1.6; 1.8 16V
	Vectra	1.6; 1.8 16V
	Zafira	1.6; 1.8 16V



Árvore de cames à direita

SAAB	900 - 9000	
OPEL	Calibra	2.5; 2.5L; 2.6 V6
	Cavalier	2.5L V6 2.5; 2.5L; 2.6 V6
	Omega-B	2.5; 2.6; 3.0; 3.2; V6
	Sintra	3.0 V6
	Vectra	2.5L; 2.6 V6



Árvore de cames à esquerda

SAAB	900 - 9000	
OPEL	Calibra	2.5; 2.5L; 2.6 V6
	Cavalier	2.5L V6 2.5; 2.5L; 2.6 V6
	Omega-B	2.5; 2.6; 3.0; 3.2; V6
	Sintra	3.0 V6
	Vectra	2.5L; 2.6 V6



ROVER	25	1.4; 1.6; 1.8VVC
	45	1.4; 1.6; 1.8
	75	1.8
	200	VI
	214	1.6V
	216	1.6V; Cabrio; Coupé
	218	Coupé
	414	1.6V
VOLKSWAGEN	Bora	1.9 TDI
	Golf	1.9 TDI
	Lupo	1.2; 1.4; 3.0 TDI
	Polo	1.4 TDI
Passat	1.9 TFI	



CITROËN	Berlingo	1.9 D
	Jumper	1.9 D; TD-FSO 1.9D;
	Jumpy	1.9 D/TD
	Synergie	1.9; 2.0 T
	Xantia	1.9; 2.0 D; TD; HDI
	Xsara	1.9; 2.0 D; TD; HDI



FIAT	Ducato	2.0 D
	Ulysse	1.8; 2.0 Turbo

FORD Maioria dos Motores Diesel

PEUGEOT	205	1.6; 1.8; 1.9 D
	305	1.6; 1.8; 1.9 D
	306	1.8; 1.9 D; TD
	309	1.6; 1.9 D
	405	1.6; 1.9 D
	406	1.9 D
	605	2.0 D; TD
	806	1.9 D
	Boxer	1.9; 2.0 D; TD
	Expert	1.9 D
	Partner	1.9 D



TALBOT	Express	D
	Horizon	D-J5D
	Solara	D

ISUZU Motores Diesel 1.5; 1.7

OPEL	Motores Diesel	1.6; 1.7
	Motores Gasolina	1.2; 1.4; 1.6; 1.8; 2.0

AI010041

100.00€

Kit comando de motores com 19 peças

Composição:

Marca	Modelo	Motorização
CITROËN	Synergie	2.0/Turbo; ZX 1.9D/TD
	Xantia	1.9D/TD
	Berlingo	1.9D
FIAT	Ulisses	2.0/Turbo
	Ducato	2.0
FORD	Fiesta	1.25; 1.4 (95-); 1.8-XR2i/RS1800 16V
	Mondeo	1.6; 1.8; 2.0 16V (93-)
	Escort/Orion	1.6; 1.8i 16V (92-)
HONDA	Accord/Prelude	2.3i (93-);
	Prelude	2.2 V-Tec; motor SOHC
	Accord	1.8, 2.0; 2.2 (-93); 2.0i (93-)
	Shuttle	2.2i;
	Civic	1.6 VTI
	Accord	(90-)
	Prelude	2.0 16V (-90)
	Discovery MPI	2.0 16V (93-), motor 20T4
LAND ROVER	Discovery MPI	2.0 16V (93-), motor 20T4
MAZDA	121	1.25
OPEL	Cavalier	2.5
	Calibra	2.5
	Vectra	2.5
	Omega	2.5; 3.0
	Sintra	3.0
	Astra	1.8; 2.0 16V
	Cavalier	2.0 16V
	Calibra	2.0 16V/Turbo
	Omega-B	1.6 16V
	Motor Gasolina OHC	1.2; 1.4; 1.6; 1.8; 2.0
	Motor Diesel OHC	1.6D i; 1.7D
	Motor Diesel OHC	
	Diesel Isuzu	1.5D i; 1.7D
	205; 305; 309; 405	1.6; 1.9
	405	1.8; 2.0 (92-)
	605	2.0
	Boxer	2.0
	205; 305	1.8; 1.9D
	306	1.8; 1.9D/TD
	309	1.8; 1.9D; 1.8TD
405	1.8TD; 1.9D	
406	1.9D	
Partner	1.9D	
Talbot/Horizon/Solara	1.9D	
J5/Talbot Express	1.9D	
605	1.9D/TD	
806	1.9TD	
Expert	1.9D	
Boxer	1.9D/TD	
RENAULT	R5	1.6D
R9	1.6D	
411	1.6D	
Express/Extra	1.6D - motores Diesel F8M	
Clio; Express/Extra		
R19	1.9D - motor diesel F8Q	
Espace	2.1D	
R21	2.1D	
R25	2.1D	
Trafic/Master	2.1D - motor Diesel J8S	
Clio	1.2; 1.4	
Express/Extra	R19 1.4	
Megane/Scenic	1.4; 1.6 - motor E7F/E7J	
R5	1.7	
Clio	1.7; 1.8	
R19	1.7	
R21	1.7	
Megane/Scenic	2.0	
Laguna	1.8; 2.0	
Trafic	1.7 - motor F3N; F3P; F2R	
Clio Williams; R19; Megane	2.0 16V - motor F7P; F7R;	
Laguna/Safrane	2.0 16V - motor N7Q/N7U	
ROVER	623	(93-)
618/620	motor SOHC (93-)	
216; 416	GTi 16V (-95) motor D16A9, motor K16 DOHC; motor SOHC 820 8V (m8)	
Metro	GTa/GTi 16V K16 (-95)	
214; 414	K16 (89-)	
216; 416	K16 (95-)	
MGF	1.8 MPI/VVC (95-)	
220	M16 (-92)	
220	Turbo T16 (92-)	
420	M16 (-92)	
420	T16 (92-)	
320	Turbo M16 (-91)	
620	Ti (94-)	
820	Turbo T16 Vitesse (91-)	
SAAB	900	2.5
	9000	3.0 V6
VW; AUDI; SEAT; SKODA		TDI desde 2000
		ECOTEC 1.4; 1.6; 1.8; 2.0 16V



AI010060

59.00€

Jogo de 4 chaves para injetores 1/2"

Composição:

	Faces	Diâmetro (mm)	Medida (mm)
A	6	22	110
B	12	22	75
C	12	27	78
D	12	28	78



AI010060-A

16.30€

Chaves para injetores 1/2"

Faces: 6
Diâmetro: 22mm
Medida: 110mm



AI010060-B

13.70€

Chaves para injetores 1/2"

Faces: 12
Diâmetro: 22mm
Medida: 75mm



AI010060-C

13.00€

Chaves para injetores 1/2"

Faces: 12
Diâmetro: 27mm
Medida: 78mm



AI010060-D

13.00€

Chaves para injetores 1/2"

Faces: 12
Diâmetro: 28mm
Medida: 78mm



AI010063A

49.00€

Medidor de tensão de correias



AI010086

120.00€

Jogo de 12 chaves para terminais

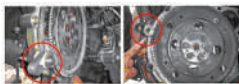

AI010092
67.00€
Bloqueador do volante do motor

AI010104
32.70€
Ferramenta para retirar a tampa do depósito de combustível

Ajustável entre 122-199mm

AI010127
4.50€
Chave de remoção da correia trapezoidal

Aplicação: VOLVO e grupo VAG

AI010137
39.00€
Organizador para peças desmontadas

AI010166
7.90€
Chave torx para polie alternador 1/2"

Medida: T50

Comprimento: 110mm

AI010167
8.00€
Chave XZN para polie alternador 1/2"

Medida: M10

Comprimento: 110mm

AI010176
37.50€
Chave de remoção do filtro de combustível

Esta ferramenta torna a tarefa rápida e fácil de executar reduzindo os riscos de danificar o alojamento plástico do filtro.

Composição:

Marca	Modelo	Aplicação
CHEVROLET	Captiva, Epica	2.0 VCDi
CITROËN	Hdi Relay	2.0; 2.2; 2.8; 3.0
FIAT	500; Doblo; Strada;	1.3 JTD
	Idea; Panda; Punto	
	Idea; Multipla; Punto;	1.9 JTD
	Sedici (+2.0 JTD)	
	Ducato	2.0; 2.2; 2.3; 2.8; 3.0 JTD
LANCIA	Musa; Ypsilon	1.3 MJTD
OPEL	Agila; Astra; Corsa;	1.3 CDTi
	Combo; Meriva; Tigra	
	Astra; Signum; Vectra;	1.9 CDTi
	Zafira	
PEUGEOT	Boxer	2.0; 2.2; 2.8; 3.0 HDI
SAAB	9-3	1.9 TiD
SUZUKI	Splash; Swift; SX4	1.3 DDiS

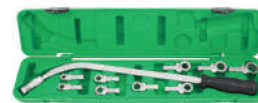
AI010195
94.00€
Chave tensionadora de correias com 10 peças

AI020015
19.90€
Grampo para válvulas

Capacidade: 60-120mm

Altura: 150mm

AI0200
Grampo para segmentos

Ref. Capacidade (mm)

Ref.	Capacidade (mm)	Preço
AI020019	115-180	24.00€
AI020020	70-108	20.40€
AI020021	50-100	18.90€

AI020024
71.00€
Grampo para válvulas

Para motores grandes/ diesel

AI020025
59.70€
Grampo para válvulas

Capacidade: 55-175mm

AI020027
29.60€
Desmonta válvulas universal com gancho

Compressor molas de válvulas

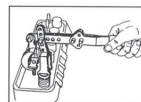
AI020048
Grampo para segmentos

Ref.	Capacidade (mm)	Altura (mm)	Preço
AI020048A	57-125	127	12.80€
AI020048D	90-175	100	14.20€
AI020048E	90-175	165	24.50€

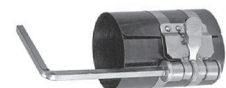

AI020043

17.00€

Alicate para abraçadeiras de foles



AI020049

66.40€

Grupo universal para válvulas



AI020051

209.00€

Kit teste de compressão para motores a diesel

BMW, CITROËN, DACIA, DAF, DAIHATSU, FIAT, FORD, ISUZU, LAND ROVER, MAZDA, MERCEDES, MITSUBISHI, NISSAN, OPEL, PEUGEOT, RENAULT, ROVER, SEAT, TOYOTA, VOLKSWAGEN, VOLVO

Manómetro: 0-70bar

Diâmetro: 80mm

Turbo: 355mm

Adaptadores:

M10x1 (73,5mm); M10x1 (114,5mm);

M10x1 (119mm); M12x1,25 (54mm);

M14x1,25 (72mm) e M20x1,5 (78mm)

Simulador bocal 19 e 21mm



AI020052

130.50€

Kit teste de medição compressão do óleo em motores a gasolina

Inclui adaptadores e reparadores com rosca

Medidas: M10; M12; M14 e M18



AI020054

136.50€

Kit teste para a pressão do óleo

Inclui adaptadores e reparadores com rosca

Manómetro: 0-10bar/80mm

Turbo: 1 300mm

Jogo de 10 adaptadores



AI020056A

21.50€

Alicate para juntas de válvulas



AI020066

69.00€

Alicates cinta de segmentos

Abertura: 73-111mm



AI020092

73.00€

Extrator de parafusos danificados

Jogo de brocas/ extrator e guias para remoção de parafusos danificados

Gama: 5 a 16mm



AI020101A

113.00€

Dispositivo para teste de injetores common rail diesel

Este dispositivo permite medir rápida e eficientemente a quantidade de combustível de retorno de cada injetor, permitindo assim verificar se existe alguma anomalia. Medição até 6 injetores em simultâneo.

Inclui adaptadores para injetores Bosch, Delphi, Denso e Siemens.



AI020101A-A

44.00€

Jogo de copos de substituição para AI020101A



AI020103

58.00€

Extrator de inércia para desmontagem de injetores

Feito de aço endurecido de alta qualidade.

Desmontagem rápida e fácil de injetores presos em motores a diesel.

Preparado para rosca M8; M12 e M14



AI020107
147.50€
Ferramenta de ajuste do ponto de injeção

Permite efetuar o ajuste do ponto de injeção em motores diesel com bomba injetora convencional.

Aplicável entre outros em veículos ALFA ROMEO, AUDI, BMW, FIAT, FORD, ISUZU, IVECO, LANCIA, LAND ROVER, MITSUBISHI, NISSAN, RENAULT, ROVER E VOLKSWAGEN.

AI020109
67.00€
Jogo de 6 chaves para velas de incandescência

Composição/ medidas (mm):

 Chaves: 8; 9; 10; 12; 14 e 16
 Comprimento: 160mm

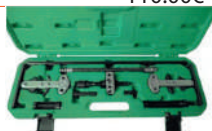
AI020131
110.00€
Compressor de molas de válvulas

AI020142
339.00€
Jogo de saca rolamentos pequenos

Composição/ medidas (mm):

 Saca
 Barra
 Expansores: 6 a 8; 8 a 10; 12 a 15 e 15 a 18

AI020162
18.90€
Alicate de pontas direitas para remoção de relays

AI020163
19.50€
Alicate de pontas angulares para remoção de relays

AI020178
295.00€
Kit remoção de velas de incandescência danificadas

AI020180
112.50€
Teste de sistemas turbo

Este kit pela insuflação de ar comprimido de baixa pressão no sistema do turbo, permite a verificação de fugas.

Composição: 4 pares de adaptadores

Ø	Medida (mm)
55-60	64
65-70	74
75-80	84
85-90	94

AI020184
13.50€
Chave para injetores MERCEDES BENZ

 Quadra: 1/2"
 Medida: 17mm
 Comprimento: 119mm

AI020184A
13.50€
Chave para injetores BMW e Volkswagen

 Quadra: 1/2"
 Medida: 14mm
 Comprimento: 119mm

AI020184B
14.00€
Chave para injetores MERCEDES BENZ

 Quadra: 1/2"
 Medida: 19mm
 Comprimento: 119mm

AI020184S
37.50€
Jogo de 3 chaves 1/2" para linha de injeção

Composição:

Ref.	Medida (mm)	Aplicação
AI020184A	14	BMW; VW
AI0200184	17	Mercedes 100, 130, 314, 360, 360h, 352A, 346/355, 401, 402, 403, 407h, 615, 616 e 617
AI0200184B	19	Mercedes 314, 352, A, 346/355, A, 401, 402/422, LA, 403, 407



AI020185 16.00€

Chave luneta aberta dobrada

Chave especial para desmontar tubos de alta pressão do sistema de combustível em motores a diesel

Medidas: 17x17mm



AI020201 62.00€

Jogo de 6 chaves de caixa com luneta aberta

Especialmente concebidas para trabalhar em espaços apertados e de difícil acesso.

Quadra: 1/2"

Comprimento: 100mm

Medidas: 12; 14; 16; 17; 18 e 19mm



AI020205 113.00€

Saca para injetores (diesel/ gasolina)

Saca especialmente concebido para a remoção de injetores Diesel e Gasolina. As garras são intermutáveis o que permite abranger um maior número de tipos de injetores.



AI030007 17.00€

Jogo de 5 peças para raspar, limpar e tirar juntas



AI050043S 19.90€

Jogo de 3 raspadores

Medidas: 15; 20 e 30mm



AI030010 3.70€

Ferramenta para rodar válvulas grandes



AI030011 3.50€

Ferramenta para rodar válvulas pequenas



AI030020 17.00€

Estetoscópio de mecânico



AI030025 5.90€

Jogo de riscador/ tira o-rings e juntas



AI030027 38.50€

Jogo de 6 riscadores com punho



AI040007 11.20€

Alicate para segmentos

Medidas: 1,2 a 6,3mm



AI040008 85.50€

Kit completo para teste de vácuo e sangrar travões



AI040031 116.00€

Bomba para vácuo e pressão com kit sangrador travões

Selecionar a válvula de controlo para a função de vácuo ou pressão.



AI040005

16.00€

Alicate de pontas curvas para anéis de segurança



AI040006

16.00€

Alicate de pontas direitas para anéis de segurança



AI040011

13.80€

Alicate para velas com pontas isoladas



AI040017

50.00€

Jogo de alicates de freios de cabeças recambiáveis

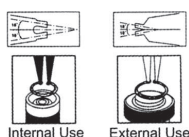

AI040018

18.20€

Alicate para abraçadeiras



AI010201

83.00€

Chave flexível para tubos de combustível

Permite trabalhar em locais com pouco espaço.



AI040060

25.50€

Alicate para tubos de combustível

Alicate para ligações rápidas de tubos de combustível.



AI040246

39.00€

Jogo para desligar tubos de combustível

Composição:

- 1 Chave direita para tubos 11,8mm
- 1 Chave direita para tubos 16mm
- 1 Chave angular para tubos 11,8mm
- 1 Chave angular para tubos 16mm



AI030002

26.00€

Jogo de 11 chaves para bujões óleo

Quadra: 3/4"

Utilização: chave de caixa 19mm

Hexagonais

8mm: BMW/ FORD/ GM

9mm: GM

10mm: FORD

12mm: FIAT/ LANCIA/ PEUGEOT/

14mm: LANCIA/ MERCEDES

17mm: AUDI/ BMW/ DAC

Quadradas + cabo

8mm: PSA/ RENAULT/ VOLVO

9,5mm: HONDA/ MAZDA/ PEUGEOT/ SAAB/ VOLVO

11mm: FORD

13mm: NISSAN/ SUBARU



AI050004

46.00€

Jogo de 15 peças de copo para filtros

Composição:

Faces	Medidas (mm)	Aplicação
14	65	GM, DAIHATSU, TOYOTA
14	65-67	DAIHATSU
14	68	MAZDA, FORD ESCORT, SUBARU
14	73	TOYOTA, LEXUS
15	74-76	SATURN
15	75-77	VW, AUDI, FORD, ISUZU, MERCEDES, OPEL
14	76	VW, PORSCHE, MERCEDES, BMW, AUDI A3, OPEL
30	76	FORD
15	80	NISSAN, HONDA, MAZDA, ISUZU, SUBARU, OPEL, TOYOTA
15	80-82	MAZDA, SUBARU, TOYOTA, HONDA, ACURA, NISSAN
15	90	HONDA ACCORD, MITSUBISHI, ISUZU
15	93	OPEL, MAZDA, VOLVO, MITSUBISHI, NISSAN, VW, PORSCHE, RENAULT, FORD, HONDA, AUDI
36	93	FORD
15	100	ISUZU, MITSUBISHI

Adaptador 1/2" (F)x3/8"(M)



HC

Chaves de copo para filtros

Ref.	Faces (mm)	Medida (mm)	Preço
HC-78/15	15	78	4.60€
HC-65/67	14	65-67	4.20€
HC-65/14	14	65	4.40€
HC-68/14	14	68	4.10€
HC-74/15	15	74	4.30€
HC-66/6	6	66	4.10€
HC-76/8	8	76	4.60€
HC-73/14	14	73	4.30€
HC-74/76	15	74-76	4.50€
HC-75/77	15	75-77	4.50€
HC-76/12	12	76	4.50€
HC-76/30	30	76	4.60€
HC-93/36	36	93	4.60€
HC-76/14	14	76	4.60€
HC-108/15	15	108	4.40€
HC-108/18	18	108	4.40€
HC-65103		65-120	14.30€
HC-106/15	15	106	4.60€
HC-100/15	15	100	4.50€
HC-86/16	16	86	4.50€
HC-90/15	15	90	4.60€
HC-80/82	15	80-82	4.60€
HC-92/10	10	92	4.60€
HC-93/45	45	93	4.60€
HC-93/15	15	93	4.60€
HC-86/18	18	86	4.60€
HC-80/15	15	80	4.60€
HC-96/18	18	96	4.60€
HC-95/15	15	95	4.60€
HC-9.5mm	adaptadores 1/2"-3/8"		1.75€

AI050004A

113.00€

Jogo de 30 peças de copo para filtros

Composição:

Faces	Medida (mm)	Aplicação
14	65	GM, DAIHATSU, TOYOTA
14	65-67	DAIHATSU
14	68	MAZDA, FORD ESCORT, SUBARU
14	73	TOYOTA, LEXUS
15	74	AUDI, GM, ROVER, CHRYSLER
15	74-76	SATURN
15	75-77	VW, AUDI, FORD, ISUZU, MERCEDES, OPEL
8	76	FIAT MAREA, LANCIA DELTA
12	76	FIAT (DUCATO, SCUDO, ULYSSE), RENAULT (MEGANE, LAGUNA, ESPACE)
14	76	VW, PORSCHE, MERCEDES, BMW, AUDI A3, OPEL
30	76	FORD
15	78	NISSAN, FORD, TOYOTA
15	80	NISSAN, HONDA, MAZDA, ISUZU, SUBARU, OPEL, TOYOTA
15	80-82	MAZDA, SUBARU, TOYOTA, HONDA, ACURA, NISSAN
16	86	Volvo (S40, S60, S70, S80)
18	86	VW (GOLF TDI, PASSAT/TDI), AUDI A6 TDI, RENAULT (CLIO, RAPID 1.9D, LAGUNA, SAFRANE, ESPACE 2.1D, CITROEN; PEUGEOT
15	90	HONDA ACCORD, MITSUBISHI, ISUZU
10	92	FIAT (CINQUECENTO, COUPE, CROMA, PANDA, REGATA, RITMO, SEICENTO, TEMPRA, TIPO), LANCIA (BETA, DEDRA, KAPPA, THEMA)
15	93	OPEL, MAZDA, VOLVO, MITSUBISHI, NISSAN, VW, PORSCHE, RENAULT, FORD, HONDA, AUDI
36	93	FORD
45	93	VW AUDI (2.4; 2.6; 2.8L)
15	95	TOYOTA, ALFA, GM, FORD, CHRYSLER
18	96	AUDI (A4, A6TDI), VW (PASSAT 97 TDI), RENAULT (LAGUNA 2.2D, SAFRANE 2.2D, ESPACE 2.2D, R19, RAPID, MEGANE 1.9/2.1D)
15	100	ISUZU, MITSUBISHI
15	106	FIAT DUCATO 2.5 TD
18	108	RENAULT (ESPACE, LAGUNA,
15	108	MASTER, SAFRANE, TRAFFIC 2.4; 2.5; 2.8D)

Chave filtro de óleo ajustável 65-120
Adaptador 1/2"(F)x3/8"(M)

AI05009A

Chave de filtros

8.00€



AI050022

Chave de filtros

Ajustável: 60-90mm

9.90€



AI050024

Jogo de 4 alavancas

Medidas: 200; 330; 540 e 600mm

20.50€



AI050001

Chave de filtros de 3 pernas

Capacidade: 60-120mm

14.50€



AI050037

Chave de filtros de 3 pernas

Capacidade: 45-110mm

16.90€



AI030067

Jogo de 17 chaves para bujões de óleo 3/8"

Composição:

6 Chaves hexagonais: 8; 9; 10; 11; 12; 13 e 14mm

9 Chaves quadradas: 7; 8; 10; 11; 12; 13 e 14mm 5/16" e 3/8"

1 Chave quadrada (fêmea): 10mm

1 Chave triangular

35.50€

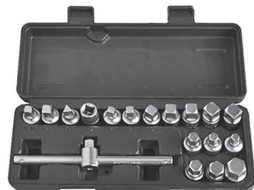

AI050040

Chave para bujões

Medidas: 8 e 10mm

8.50€



AN01009A

Chave para bujões de carter

Medidas (mm): 10; 11; 12; 13; 14; 15 e 17mm

Comprimento: 150mm

6.80€



AN010030

Alicate para remoção de pesos de rodas

12.10€



AI050042

Chave para remoção de ventoinha

Medidas: 8 e 10 mm

15.30€

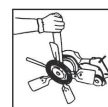

AI050043

Alicate de pressão para filtros de óleo

Medida: 53-118mm

18.00€



AI050076

Chave de filtros ajustável 1/2"

Medida: 60-80mm

53.00€



AI050077

Chave de filtros de cinta

Medida: 25-160mm

16.50€



AI050080

Chave para parafusos cabeça do motor 1/2"

Medida: M9

Comprimento: 100mm

8.50€



AI05009

Chave de velas longa 3/8"

Ref.	Medida (mm)	Compr. (mm)	Preço
AI050092	14	250	13.00€
AI050093	16	250	14.50€



AI050096S

50.00€

Jogo de 7 chaves especiais

Sensores de vácuo e de oxigénio
Válvulas pressostáticas



AI050102

68.50€

Chave de filtros 3 pernas auto ajustáveis

Capacidade: 95-165mm



AI050202

9.00€

Chave de copo para filtros de 14 faces 3/8" com 54mm

Marca	Modelo	Motorização
TOYOTA	Auris/ Corolla/ Prius	1.8/ 2.0 4 cilindros



AI010033

6.70€

Chave para sensor de oxigénio



AI050104

17.90€

Chave para sensor de oxigénio

Medida: 22mm



AI050109

43.50€

Chave de filtros de corrente

Comprimento: 350mm
Filtros: 60 a 105mm



AI050113

170.00€

Jogo de bits impacto de 3/4" e 1"

Composição/ medidas (mm):
5 Chaves torx T60, T70, T80, T90 e T100 (107mm)
4 Chaves hexagonais 17, 19, 22 e 24mm (107mm)
4 Chaves torx E18, E20, E22 e E24 (107mm)
1 Chave sextavada 3/4" 22mm
1 Chave sextavada 1" 22mm
1 Chave hexagonal em L 4mm



AI050152

16.50€

Tubo para descarga de óleo usado do alojamento do filtro



AI050152A

10.50€

Tubo para descarga de óleo usado do alojamento do filtro

Aplicação: TOYOTA e LEXUS



AI050176

170.00€

Kit para montagem de correias estriadas com 11 peças

Composição:

Marca	Modelo
AUDI	A3
BMW	118/ 120/ 318/ 325/ 330/ 335/ 520/ 525/ 530/ 535/ 635/ 720/ 730/ X3/ X5
CITROËN	C2/ C3/ C4/ Jumper/ Relay
CHRYSLER	Grand Voyager/ Voyager
FIAT	Albea/ Doblo/ Ducato/ Fiorino/ Marea/ Multipla/ Qubo/ Linea/ Palio/ Siena/ Stilo e Strada
FORD	C-Max/ Courier/ Fiesta/ Focus C-Max/ Fusion/ Mondeo/ Tourneo/ Transit
IVECO	Daily
LANCIA	Lybra
MAZDA	2/ 3/ 5/ Axela
MERCEDES	Sprinter/ Viano/ Vito
MITSUBISHI	ASX
PEUGEOT	206/ 207/ 307/ Boxer
SEAT	Altea/ Ibiza
SKODA	Octavia/ Yeti
VOLKSWAGEN	EOS/ Golf/ Passat/ Polo/ Sirocco
VOLVO	C30/ S40/ V50



AL010093
28.00€

Ferramenta para montagem/ desmontagem de correias elásticas poli-v

AI050191
11.00€

Chave magnética para bujões

AE300180
41.00€

Funil para líquido refrigerante

 Dimensões: 160x160x260mm
 Funil + 2 adaptadores

AI050192
33.00€

Funil universal para óleo

Grampo de fixação ajustável: 28-74mm

AI060006
7.30€

Reparador "rosca" alojamento de velas

Medida: 14mm

AI060020
3.60€

Apalpa folgas com 20 lâminas

Medidas (mm): 0,05; 0,10; 0,15; 0,20; 0,25; 0,30; 0,35; 0,40; 0,45; 0,50; 0,55; 0,60; 0,65; 0,70; 0,75; 0,80; 0,85; 0,90; 0,95 e 1

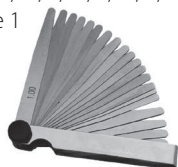
AI060030
165.00€

Kit de reparação de rosca de alojamento de velas com 56 peças

AI060030
Helicoides

Ref.	Medida	Quadra	Quantid.	Preço
AI060030-A	M10x1,0	3/8	10	6.30€
AI060030-B	M12x1,25	3/4	10	12.40€
AI060030-C	M14x1,25	7/16	10	15.50€

AI060030
Punção

Ref.	Medida	Quantid.	Preço
AI060030-D	M10x1,0	1	10.40€
AI060030-E	M12x1,25	1	13.40€
AI060030-F	M14x1,25	1	19.40€

AI060031
120.00€

Kit reparador de rosca com 87 peças

 Composição: Medidas:
 Helicoides: 25x M6x1.0x1.5 (9mm)
 25x M8x1.25x1.5 (12mm)
 25x M10x1,5x1,5 (15mm)

 Macho: M6x1.0
 M8x1.25
 M10x1.5

 Punção: M6x1.0
 M8x1.25
 M10x1.5

 Broca: 6,3mm
 8,3mm
 10,4mm

 Punho: M6x1.0
 M8x1.25
 M10x1.5



AI060031

Helicoïdes

Ref.	Medida	Quantid.	Preço
AI060031-A	M6x1,0	10	4.60€
AI060031-B	M8x1,25	10	5.70€
AI060031-C	M10x1,5	10	7.60€

AI060031

Punção



Ref.	Medida	Quantid.	Preço
AI060031-D	M6x1,0	1	6.40€
AI060031-E	M8x1,25	1	8.60€

AI060031

Broca

Ref.	Medida (mm)	Quantid.	Preço
AI060031-G	6,6	1	4.40€
AI060031-H	8,3	1	7.70€
AI060031-J	10,4	1	11.00€



AL010006

27.30€

Jogo de 3 alicates

Para ligações rápidas de tubos de combustível



AL010011

19.50€

Chave para fêmeas suspensão

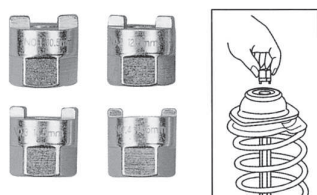

AN010001

43.50€

Kit de ferramenta para travões com 11 peças

Para recuar e rodar êmbolos dos travões



AN010001C

58.00€

Kit de ferramenta para travões com 18 peças

Para recuar e rodar êmbolos dos travões



AN010001D

157.00€

Kit de ferramenta para travões

Para recuar e rodar êmbolos dos travões

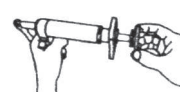
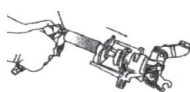

AN010001D

Adaptadores

Ref.	Marca	Preço
AN010001D-2	Citroën, Honda	6.00€
AN010001D-3	Vários	6.30€
AN010001D-4	Vários	4.20€
AN010001D-5	Adaptador 3/8"	5.70€
AN010001D-6	Nissan, VW	4.20€
AN010001D-7	Vários	4.20€
AN010001D-A	Renault	4.20€
AN010001D-E	Nissan, Ford	4.20€
AN010001D-F	Opel	4.20€
AN010001D-K	Citroën	6.80€
AN010001D-M	Vários	4.20€
AN010001D-N	Ford, Mazda, Mini	4.20€



AN010293

31.00€

Chave especial para pressionar as pinças de travão

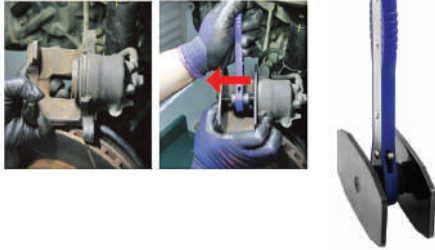

AN010033

4.40€

Removedor do interior de válvulas



AN010085A

13.20€

Ferramenta para colocar válvulas de pneus



AN010038

7.10€

Extrator de vedantes



AN010049

11.00€

Centrador de embraiagens



AN010063

56.50€

Alicate para freios de travão



AN010065

56.80€

Jogo de 4 pinças para cilindros de travão



AN010081A

22.50€

Alicate de molas de travões



AN010160

17.50€

Ferramenta para verificação da altura dos calços de travão



AN010066

41.30€

Kit de desmontagem de embraiagem do compressor A/C

Aplicável em várias marcas de compressores A/C



AN010054A

21.00€

Jogo de 3 alicates para oclusão de tubos



AN010054N

19.90€

Alicate de pressão para tubos



AR060062

32.00€

Alicate tensor para abraçadeiras de tubos

Amplitude: 5 a 55mm



AN010068

5.50€

Limpa bornes e terminais de bateria



AN010072 28.00€

Reparador de roscas interno e externo

Medidas das roscas: 0,8; 1; 1,25; 1,50; 1,75; 2 e 3mm



AN010072C 16.50€

Reparador de roscas SAE (polegadas)

Medidas das roscas: 9"; 10"; 16"; 20"; 27"; 28" e 32"



AN010091A 83.00€

Removedor da barra de direção

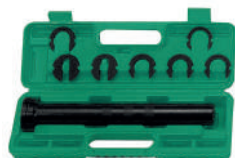

AN010092 49.00€

Chave excêntrica para direções/ barras

Medida: 33-42mm



AI030075 25.00€

Alicate para tubos de escape



AN010106A 43.50€

Corta tubos de escape

Não utilizável em tubos de aço inox

Medidas: 19 a 76mm de diâmetro



AN010112 18.00€

Adaptador para saca de semieixo



AN010131 16.00€

Rolete calçador



AN010137 70.00€

Alicate para cubos de rodas



AN010186B 540.00€

Kit para embraiagens auto ajustáveis



AN010188

Ferro desmonta pneus

Ref.	Medida (mm)	Preço
AN010188A	500	19.50€
AN010188C	200	4.00€



AN010225 520.00€

Ferramenta para instalar/ remover rolamento manga eixo

Permite rapidez, segurança e profissionalismo sem esforço na tarefa

Aplicação: PEUGEOT, CITROËN e RENAULT



AN010226 15.30€

Medidor de espessura dos discos de travão e profundidade do piso dos pneus

Discos de travão: 0-60mm

Material: alumínio

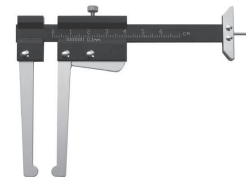

AG010205
18.90€
Medidor digital de profundidade

Utilizado para medir a profundidade do piso dos pneus e das pastilhas de travões.

Especificações:

Gama de medição: 0-25,4mm

Resolução: 0,01mm

Display: LCD

Medição em milímetros ou polegadas.

Utiliza pilhas SR44/ LR44 de 1,4V (não incluídas).

AN010272
13.30€
Alicate para tampas plásticas fêmea da roda

Permite retirar as tampas plásticas das fêmeas da roda sem danificar as jantes.

AN010279
325.00€
Mecanismo para desbloqueio de roda MB/ BMW

Aplicação

Mercedes Benz: W164 (Classe GL); W197 (SLS); W204 (Classe C); W212 (Classe E); W221 (Classe S) e W251 (CLR)

BMW: F01/F02 (Série 7); F07/F10 (Série 5);

F12/F13 (Série 6); F25 (x3) e

F30/ F31/ F32/ F33/ F34 (Séries 3 e 4)

AN020007
27.50€
Despolidor de cilindros

Medida: 51-177mm

AN020007-1
11.50€
Jogo de 3 pedras para despolidor de cilindros

Aplicável ao despolidor AN020007

AN020022
27.50€
Jogo de despolidor de cilindros

Composição/ medidas (mm):

Medida: 18-89

Pedras: 19; 28,8 e 51

Jogo de pedras de substituição

AN020022
Jogo de pedras para despolidor de cilindros

Ref.	Medida (mm)	Unidades	Preço
AN020022-A	51	3	7.60€
AN020022-B	28,8	2	5.80€
AN020022-C	19	3	5.20€
AN020022-D	28,8	2	5.00€

AN040035A
15.00€
Corta tubos

AN040043A
51.00€
Jogo de cortar tubos e abocardador

Composição/ medidas (mm):

Fixador de tubos: 4; 6; 8; 10; 12; 15 e 16

Punções abocardador: 4; 6; 8; 10 e 12

AN040082
112.00€
Jogo de extrator de fêmeas danificadas com 9 peças 3/8"

Medidas: 10; 11; 12; 13; 14; 15; 16; 17 e 19

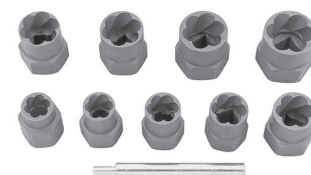
AN040101
6.90€
Bit 1/2" pentagonal para freios travões

AN040168
360.00€
Jogo de ferramenta para instalar/ remover rolamentos de roda

Permite rapidez, segurança e profissionalismo sem esforço na tarefa

Para rolamentos: 60 a 85mm



AR020018

19.90€

Teste de compressão

Tubo flexível com adaptador: 14 e 18mm
Escala: 0-300psi; 21kg/cm²; 21bar e 2 100kpa



AR020019

21.40€

Teste de vácuo e bomba combustível



AR020053A

215.00€

Kit de acessórios eletricitista/ eletrónica auto



AR030013

3.80€

Densímetro para líquido de baterias



AR030034

5.60€

Auto tester circuitos entre 3-48V
Indicação da polaridade por Leds



AR030041

58.70€

Jogo de 7 aplicadores de o-rings

Composição/ medidas (mm):
14,4-16; 15,9-17,5; 17,5-19,1; 20,7-22,4;
24-26; 25,5-27,5 e 30,3-32,3



AR030047

23.50€

Teste fluido de travões
Bateria não incluída.



AR030062

36.00€

Teste de atuadores

Este aparelho permite o teste a componentes electrónicos que atuem por campos magnéticos e eletromagnéticos.



AR040043

15.10€

Saca terminais de cabo de bateria e limpa parabrisas



AR040016

78.00€

Jogo de cabos de arranque de bateria 500 Amp

Dimensões: 0.3x268x12mm
Comprimento: 3 600mm



AR060002A

19.70€

Alicate para abraçadeiras - matriz "+"



AR060003

14.20€

Alicate para abraçadeiras - matriz "V"



AR060008

15.30€

Alicate para abraçadeiras de filtros de combustível e tubos de vácuo



AR060011

10.20€

Dispositivo para bloquear tubos



AR060020

12.30€

Alicate para remover tubos



AR060021

41.20€

Alicate para abraçadeiras



AR060024A

157.00€

Kit de 7 alicates para abraçadeiras



AN010177B

55.00€

Alicate especial para abraçadeiras de fole



AR060029

48.00€

Alargador de foles

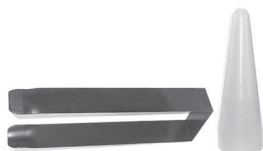

AR060032

15.80€

Kit de adaptadores para desenganche de tubos A/C



AR060043

101.00€

Jogo de 52 peças para remoção de rádios

Aplicação:

Marca Auto: AUDI; BMW; FIAT; FORD; SKODA;

MERCEDES; OPEL; PORSCHE e VOLKSWAGEN

Marca Rádio: Becker; Blaupunkt; Clarion; JVC;

Grundig; Kenwood; Panasonic; Pioneer e Sony



AR060055

23.00€

Alicate de abraçadeiras de tubos

Abertura de 22 a 55mm



Ferramenta - aplicação especial por MARCAS
GRUPO BMW e MINI

AI010121

57.00€

Chave para boia do depósito de combustível

Aplicação: AUDI, BMW, MERCEDES,
PORSCHE e VOLKSWAGEN

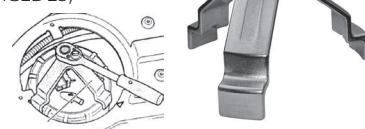

AI010139

105.00€

Ferramenta para desmontagem do sensor
do nível de combustível

Aplicação: BMW e MINI

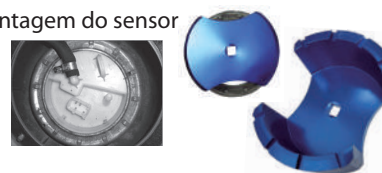

AL010099

233.00€

Kit comando de motor diesel BMW

Modelo	Motorização
E34/ E36/ E38/ E39/ E46/	M41/ M51/ M47TU/ M47T2/
E53/ E60/ E61/ E63/ E65/	M57TU/ M57T2
E66/ E70/ E83/ E87/ E90/ E91/	
Land Rover	2.5DT/ 3.0TD6/
Freelander	2.0TD4



AL010128

50.00€

Kit comando de motor BMW

Modelo	Motorização	Ano
118d	E87	2003-2007
120d	E87	2003-2007
318d/td	E46 E90/91	2000-2008
320d/crd	E46 E90/91	1997-2008
325d	E90/91/92/93	2006-2010
330d/xd/crd	E46 E90/91/92/93	1998-2008
510d	E39 E60/61	1999-2010
525d/xd	E39 E60/61	1999-2010
530d/xd	E39 E60/61	1998-2010
535d	E60/61	2004-2010
635d	E63/64	2004-2010
730d	E38 E65/66	2003-2010
X3 2,0d	E83	2003-2007
X3 3,0d	E83	2003-2010
X5		



AI010115

25.00€

Saca bombas injetoras BMW

Modelo	Motorização
318D/ 320D/TD/ 330D	E46
525D/ 530D	E39
525D/ 530D/ 535D	E60/E61
730D	E38
X5 3,0D	E53

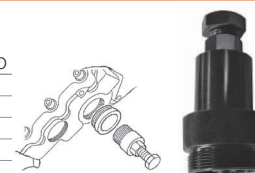

AI020184A

13.50€

Chave para injetores BMW e Volkswagen

Quadra: 1/2"

Medida: 14mm

Comprimento: 119mm



AI050071S

299.00€

Jogo de 8 chaves especiais BMW

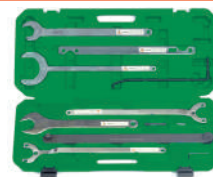

**Ferramenta - aplicação especial por MARCAS
FIAT e OPEL**

AL010044

149.00€

Kit comando de motor FIAT/ OPEL

Marca	Modelo	Motorização	Ano	Peças nº
FIAT	Panda/ Idea/ Doblo	1.3JTD MultiJet	2004-2007	7; 8; 9; 10
		1.7D/ 1.9D/ TD/ JTD2.4		1; 3; 4
		1.9/ 2.4JTD 16V/ 20V		2; 3; 4; 5; 6; 7
OPEL	Agila/ Corsa/ Astra H/ Tigra B/ Meriva/ Astra/ Vectra/ Signum/ Zafira	1.3CDTI	2004-2007	7; 8; 9; 10
		1.9CDTI		2; 3; 4; 5; 6; 7
ALFA ROMEO	147/ 156	1.9JTD 16V/ 2.4JTD 20V		2; 3; 4; 5; 6; 7



AL010196

47.00€

Kit comando de motor gasolina

Marca	Modelo	Motorização
ALFA ROMEO	159	939A4.000
CHEVROLET	Aveo/ Cruze/ Orlando	
FIAT	Croma	939A4.000
OPEL	Astra G/ Astra H/ Corsa D/ Meriva A/ Zafira B/C/ Vectra C/ Signum/ Insignia	Z16LEL/ Z16LER/ Z16LET/ Z16ZE1/ Z16XEP/ Z16ZER/ LLu/ A16LET/ A16XEL/ 2HO/A18XEL/ 2HO/A18XE R/Z18XER



**Ferramenta - aplicação especial por MARCAS
FORD, MAZDA e VOLVO**

AL010070

22.00€

Kit comando motor FORD/ PEUGEOT/ CITROËN

Marca	Modelo	Motorização:	
FORD	Fiesta/ Fusion	1.4TDCI	
		Focus/ Focus C-Max	1.6TDCI
		Fusion/ Fiesta	1.6TDCI
CITROËN	C4	1.6HDI	
PEUGEOT	206	1.4HDI	
PEUGEOT	307	HDI	



AL010071

73.00€

Kit comando motor FORD

Modelo	Motorização	Ano
Fiesta	1.8D Turbo	
Focus		
Focus C-Max	1.8TDCI	
Tourneo Connect	1.8TDDI/ TDCI	
Transit Connect	1.8TDDI/ TDCI	2002-2006



AL010107

68.00€

Kit comando motor FORD

Modelo	Motorização em diesel
Fiesta	1.8TDDI/ TDCI
Focus	Turbo
Transit	
Transit Connect	



AL010175

29.00€

Pino de fixação árvore de cames

Marca	Modelo	Motorização	Ano
FORD	Fiesta/ Fusion	1.4TDCI	2002>2009
	Focus C-Max	1.4/ 1.6TDCI	
	Mondeo	2.0TDI/ TDCI/ 2.2TDCI	
	Transit	2.0TDI/ TDCI/ 2.4TDI/ TDCI	
		2.0TDI/ TDCI/ 2.4TDI/ TDCI	
VOLVO	S40/ V50	1.6D/ 1.9D	



**Ferramenta - aplicação especial por MARCAS
FORD, MAZDA e VOLVO**
AL010205
7.70€
Kit comando motor FORD/ MAZDA/ VOLVO

Marca	Modelo	Motorização
FORD	C-Max/ Cougar/ Fiesta/ Focus	HWDA/ HWDB/ CSDA/ QQDA/ QQDB/ QQDC/ AODA/ AODB/ DBA/C/ EDBB/ EDBD/ F8JA/ F8JB/ FUJA/ FUJB/ M7JA/ M7JB/ FXJA/ FX JB/ FYJA/ FYJB/ N4JB/ FHA/ FHE/ L1T/ L1V/ ASDA/ ASDB/ FXDA/C/ FXDB/D/ FYDA/C/ FYDB/D/ EYDB
MAZDA	6	
VOLVO	C-30/ S40/ S80/ V50/ V70	B4164S3/ B4184S11/ B4204S3

AL010218
135.00€
Kit comando motor FORD
Modelo:

Fiesta/ Fusion/ Focus/ C-Max/ B-Max/ S-Max/ Mondeo/ Galaxy

AN040286
315.00€
Extrator de sinoblocos

Marca	Modelo	Ano
FORD	Focus I	1998-2005
	Focus II	2004-2008
	CB4	2008-2011
MAZDA	3	2003-2008
	3	2009 ->
	5	2005-2010

**Ferramenta - aplicação especial por MARCAS
HYUNDAI e KIA**
AL010282
60.00€
Kit comando motor HYUNDAI/ KIA
Aplicação:

HYUNDAI: Accent; Elantra; Getz; i10; i20; i30; i40; ix35; ix55; Matrix e Tucson.

KIA: Carens; Cee'd; Cerato; Optima; Picanto; Pro-Cee'd; Rio; Soul; Sportage e Venga.

**Ferramenta - aplicação especial por MARCAS
MERCEDES**
AG010204
9.00€
Chave de impacto para rodas especial - MERCEDES 1/2" com 17mm
Aplicação:

MERCEDES: W204 (Classe C); W204(GLK); W207/ W211/ W212 (Classe E); W166 (Classe M); W221/ W222 (Classe S); W172 (SLK); W164/ W166 (ML) e W216 (CL) e Maybach.

AI010114
31.50€
Jogo de ferramentas para airbag

AI010097
16.70€
Chave hexagonal 1/2" especial para SCANIA e MERCEDES
Comprimento: 27mm

AI010116
42.50€
Saca velas de incandescência
Motorização: 611/ 612/ 613
Comprimento: 10mm

Ferramenta - aplicação especial por MARCAS MERCEDES

AI020113

141.00€

Jogo saca injetores common rail MB

Motorização:
OM 611/ OM 612/ OM 613



AI020184

13.50€

Chave para injetores MERCEDES BENZ

Quadra: 1/2"
Medida: 17mm
Comprimento: 119mm



AI020184B

14.00€

Chave para injetores MERCEDES BENZ

Quadra: 1/2"
Medida: 19mm
Comprimento: 119mm



AI020186

54.00€

Jogo saca bicos injectores

Modelo	Motorização
Classe C/ Classe E/ Sprinter	108CDI/ 110CDI 16V/ 112CDI 16V/ C220CDI 16V/ E200CDI 16V



AI050071S

299.00€

Jogo de 8 chaves especiais MB

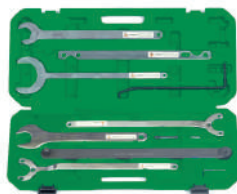

AI050085A

14.80€

Chave de filtros de 14 faces com 74mm

Nota: Se usar com uma chave caixa de 27mm, deve ser aplicada uma força máxima de 25Nm, caso sejam aplicadas forças superiores, corre-se o risco de danificar a chave filtros.

Marca:

MERCEDES/AUDI A3/ BMW E36/ CITROËN/
FIAT/ FORD/ LANCIA/ MAZDA/ NISSAN/
OPEL/ PEUGEOT/ PORSCHE/ RENAULT/
TOYOTA/ VOLKSWAGEN Golf IV



AI050200

71.00€

Jogo de 4 varetas para óleo de transmissão

Aplicacion: Mercedes Benz



AL010057

128.00€

Chave bloqueadora de cambotas MB



AN040126

195.00€

Extrator de sinoblocos eixo traseiro MB



Ferramenta - aplicação especial por MARCAS GRUPO PSA - PEUGEOT/ CITROËN

AI010136

96.00€

Kit comando motor HPI (gasolina) e HDI (diesel) PEUGEOT/ CITROËN

Marca	Modelo	Motorização	Ano
PEUGEOT	206/ 307/ 406	1.8 16V	2000-2004
	607/ 806/ 807	2.0 16V	2002-2005
	Expert		
CITROËN	C4/ C5	1.8/ 2.0HPI	2002-2005
	Xsara	2.0 16V	2002-2005
	Xsara Picasso	1.8/ 2.0 16V	2002-2005
	Evasion/ C8 Jump		

Códigos motor: 6FZ (EW7J4)/ FRN (EW10J4/L4/5)/ RLZ (EW10D)



AL010175

29.00€

Pino de fixação árvore de cames

Marca	Modelo	Motorização
CITROËN	C1/ C2/ C3/ Xsara	1.4HDI
	C3/ C4	1.6HDI
PEUGEOT	107/ 206/ 207	HDI
	307	1.4/ 1.6HDI



**Ferramenta - aplicação especial por MARCAS
GRUPO PSA - PEUGEOT/ CITROËN**
AN040100
6.60€
Chave de caixa pentagonal para travões PSA

Medida: 17mm

AL010041
147.00€
**Kit comando motor HPI (gasolina) e HDI (diesel) PEUGEOT/
CITROËN**

Marca	Modelo	Motorização	Ano	
CITROËN <i>Diesel</i>	Visa/ BX/ ZX/ Xantia/ Xsara/ Synergie/ C15/ Berlingo/ Dispatch/ C25/ Relay	1.7/ 1.8/ 1.9/ D/ TD	1984-2002	
	Saxo/ AX/ Xsara	1.5D	1994-2007	
	Xsara/ Berlingo/ Dispatch	1.9D	1998-2007	
	Xsara/ Xsara Picasso/ Xantia/ C5/ Synergie/ Berlingo/ Dispatch/ Relay	2.0HDI	1998-2007	
	C4	2.0HDI	2004-2008	
	C5	2.2HDI	2000-2004	
	C8	2.0/ 2.2/ HDI	2002-2007	
	Relay	2.5D/ TurboD	1994-2002	
	XM/ Xantia/ Dispatch/ Synergie/ Evasion	2.1D/ 2.2D/ TD	1994-2002	
	CITROËN <i>Gasolina</i>	AX/ Xsara/ AX GTi/ Saxo/ ZX/ Berlingo	1.0/ 1.1/ 1.4/ 1.6	1994-2004
		C2/ C3/ C3 Pluriel/ Berlingo	1.0/ 1.1/ 1.4	2002-2007
		Saxo/ Xsara	1.6 16V	1997-2006
		C2/ C3 Pluriel/ C4	1.6	1997-2006
		Xsara/ Xantia	1.8 16V	2002-2008
		ZX/ Xsara	2.0 16V	1996-2000
		Synergie/ Evasion/ Relay/ Jumper	2.0 Turbo	1994-2002
		Xsara	2.0 16V	2000-2004
		Xsara/ C5/ Xsara Picasso	2.0HPI/ 2.0 16V/ 1.8	1999-2002
		Xsara/ C5/ Xsara Picasso	2.0HPI/ 2.0 16V/ 1.8	2002-2008
		205/ 305/ 405/ Partner/ 306/ 309 Talbot Horizon/ Solara Express	1.8/ 1.9/ D/ TD	1982-2001
206/ 307		1.4 HDi	2001-2008	
206/ 306/ Express/ Partner	1.9D	1998-2007		
206/ 306/ 307/ 406/ 806/ 807	2.0HDI/ 2.0HDI 16V	1997-2007		
307/ 307 CC/ 407	2.0HDI	2003-2008		
406/ 607	2.2HDI	2002-2007		
406/ 806/ Expert/ Boxer	1.9D/ TD	1994-2002		
406/ 605/ 806	2.1D Turbo	1994-2002		
PEUGEOT <i>Gasolina</i>	106/ 205/ 306/ 307/ 405/ Partner	1.0/ 1.1/ 1.4/ 1.6	1993-2008	
	206	1.1/ 1.4/ 1.6	1998-2008	
	205/ 309/ 306/ 405/ 806/ 605/ 406/ Partner/ Boxer	1.6/ 1.9/ 1.8/ 2.0	1989-2002	
	206/ 307	1.6 16V	2000-2008	
	306/ 407	1.8 16V	1999-2002	
	206/ 307/ 406/ 406 Coupe/ 607/ 806	2.0 16V	1998-2000	
	306/ 406	1.8 16V	1995-1998	
	306/ 406	2.0 16V	1994-2001	
	306/ 406	1.6/ 2.0 Turbo	1994-2001	
	406	1.8 16V	2000-2004	
	406/ 406 Coupe/ 607	2.2 16V	1998-2008	
	807	2.0 16V	2002-2005	

RENAULT, NISSAN e DACIA
AL010038
17.90€
Kit comando de motor RENAULT/ NISSAN

Marca	Modelo	Motorização
RENAULT	Modus/ Laguna/ Kangoo/ Clio	1.5dCI/ 1.9dCI
NISSAN	Almera/ Micra	1.5dCI

AL010190
48.00€
Kit comando de motor

Marca	Modelo	Motorização	Ano
RENAULT	Clio	1.2/ 1.4/ 1.6	
	Clio Sport	2.0	
	Espace	2.0	
	Scenic	1.4/ 1.6/ 1.8/ 2.0	
	Scenic II	1.4/ 1.6/ 2.0	
	Grand Scenic II	1.4/ 1.6	
	Laguna	1.8/ 2.0	
	Laguna II	2.0	
	Megane	1.4/ 1.6/ 1.8/ 2.0	
	Megane II	1.4/ 1.6/ 2.0	
DACIA	Logan	1.4/ 1.6	
	Sandero	1.4/ 1.6	
NISSAN	Micra		2003>2008
	Almera		2002>2006
	Note		2006>2008
	Qashqai		2007>2008
<i>Diesel</i>		1.2/ 1.4/ 1.6/ 1.8 (8v-16v)/ 2.0IDE/ 2.0Turbo	

Códigos motor: D4F/ K4J/ K4M/ K7M/ K9K/ F4P/ F3R/ F4R/ F5R/ F4RT



Ferramenta - aplicação especial por MARCAS GRUPO VAS - AUDI, VOLKSWAGEN, SKODA, SEAT e PORSCHE

AI010069 21.50€

Ferramenta de bloqueio da cambota VOLKSWAGEN

Para bloquear a cambota quando se quiser substituir a correia ou outros componentes.

Marca	Modelo	Motorização
AUDI	A4/ A6	
SEAT	Alhambra/ Altea/ Arosa/ Cordoba/ Ibiza/ Leon/ Toledo	
VOLKSWAGEN	Bora/ Golf/ Lupo/ Passat/ Polo	TDI's

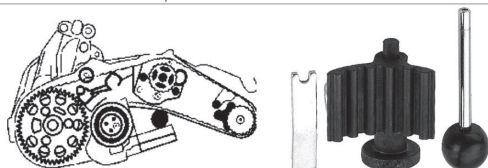

AI010070 26.50€

Ferramenta de bloqueio da cambota (VAS)

Marca	Modelo	Motorização
AUDI	A2	1.4TDI
	A3	1.9TDI/ 2.0TDI
	A4	1.6TDI/ 1.9TDI/ 2.0TDI
	A6	1.9TDI
SEAT	Altea	1.9SDI/ TDI
	Leon	1.9/ 2.0TDI
	Toledo	1.9SDI/ TDI
VOLKSWAGEN	Beetle/ Bora/ Sharan	1.9TDI
	Fox/ Lupo	1.4TDI
	Golf	1.9/ 2.0TDI
	Polo	1.4/ 1.9TDI



AI020127 39.50€

Ferramenta para tirar injetores

Aplicação: Grupo VAS (motores TDI)



AI020154 235.00€

Instalador vedante da cambota VOLKSWAGEN

Marca	Modelo	Ano
AUDI	A3	2004>
	A4	
SKODA	Octavia2/ Roomster/ Fabia	
VOLKSWAGEN	Golf	2004>
	Transporter T5/ Caddy/ Touran	2004>



AI020184A 13.50€

Chave para injetores BMW e VOLKSWAGEN

Quadra: 1/2"
Medida: 14mm
Comprimento: 119mm



AI050079 11.20€

Chave bujão caixa de velocidades e transmissões 1/2"

Marcas: AUDI e VOLKSWAGEN
Chave estriada XZN Tamperproof M16



AI050201 31.00€

Varetas para óleo

Aplicação: Audi/ Volkswagen



AL010029 27.90€

Ferramenta de alinhamento dupla árvore cames motores gasolina

Marca	Modelo	Motorização
AUDI	A2	1.4/ 1.6
SEAT	Arosa/ Ibiza/ Cordoba/ Toledo/ Leon/ Inca	1.4/ 1.6
SKODA	Fabia/ Octavia	1.4/ 1.6
VOLKSWAGEN	Lupo/ Polo/ Golf/ Bora/ Beetle/ Caddy	1.4/ 1.6



AL010053A 52.00€

Kit comando do motor

Marca	Modelo	Motorização	Ano
VOLKSWAGEN	Polo	1.2 6V/ 12V	2002>
SEAT	Ibiza	1.2 6V	2002>
SKODA	Fábia	1.2 6V/ 12V	2003>



AL010072
6.90€
Kit comando do motor

Marca	Modelo
AUDI	A4/ S3/ A6/TT
SEAT	Ibiza/ Cordoba/ Leon/ Toledo/ Alhambra
SKODA	Octavia
VOLKSWAGEN	Golf/ Bora/ Beetle/ Passat

AL010087
169.00€
Kit comando de motor AUDI

Marca	Modelo	Motorização
AUDI	A4	3.2FSI
	A6	2.4
	A6	2.4quattro
	A6	3.2FSI A)
	A8	3.2FSI A

AL010088
68.00€
Kit comando de motor a gasolina

Marca	Modelo	Motorização
AUDI	A3	1.4L/ 1.6 FSI
SKODA	Octavia	
VOLKSWAGEN	Polo/ Golf/ Golf Plus/ Jetta/ Passat/ Touran	

AN010202
23.00€
Chave de impacto especial XZN 3/4" para cubos rodas AUDI/ VOLKSWAGEN

 Medida: M18
 Comprimento: 105mm

AN010202B
10.80€
Chave de impacto XZN 1/2" AUDI/ VOLKSWAGEN

Especialmente concebida para o aperto dos parafusos que fixam o eixo traseiro

 Medida: M18
 Comprimento: 78mm

AI010108
20.50€
Ajustador do rolete tensionador

Marca	Modelo
AUDI	A4/ A6/ Cabrio
SEAT	Ibiza
SKODA	Superb
VOLKSWAGEN	Polo/ EOS/ Passat

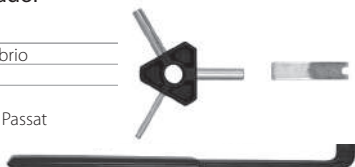
AI010110
179.50€
Jogo sincronismo motor - grupo VAS

Marca	Modelo	Motorização	Ano
AUDI	A3	1.6FSI	2003-2006
	A3/ S3	1.8Turbo	1996-2003
	A4/ A6	1.8Turbo	1994-2006
	Cabriolet		1997-2000
	TT	1.8Turbo	1998-2006
SEAT	Ibiza	1.8Turbo	1999-2002
	Cordoba	1.8Turbo	
	Leon	1.8Turbo	1999-2005
	Toledo	1.8Turbo	1999-2005
SKODA	Octavia	1.8Turbo	1996-2005
	Octavia	1.8Turbo	2000-2005
	20V RS		
VOLKSWAGEN	Golf	1.6FSI	
	Touran	1.6FSI	
	Beetle	1.8Turbo	1999-2006
	Golf/ Bora	1.8Turbo	1997-2005

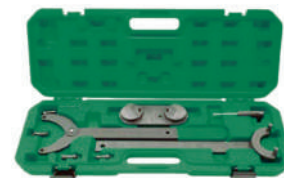
AL010202
5.50€
Pino fixação cambota - grupo VAS

Esta chave é equivalente à ferramenta especial VAG T10340

Marca	Modelo	Motorização
VOLKSWAGEN	Polo/ Golf/ Golf VI Cabrio/ Golf Plus/ Golf Variant/ Touran/ EOS/ Passat/ Jetta/ Scirocco/ Beetle/ Sharan/ Tiguan/ Caddy/ Caddy Maxi/ Fox	1.4/1.6TSI/FSI
AUDI	A3	1.4/1.6TSI/FSI
SEAT	Cordoba/ Ibiza	1.4/1.6TSI/FSI
SKODA	Fabia/ Roomster	1.4/1.6TSI/FSI



Códigos de motor: AWY/ AXU/ AZQ/ BAG/ BBM/ BKG/ BLF/ BLG/ BLN/ BLP/ BMD/ BME/ BMY/ BTS/ BWK/ BZG/ CAVA/ CAVB/ CAVC/ CAVD/ CAXA/ CEVA/ CGPA/ CGPB/ CHFA

AL010203
5.50€
Pino de fixação da cambota - grupo VAS

Esta chave é equivalente à ferramenta especial VAG T40069

Marca	Motorização
AUDI/ SEAT/ SKODA/ VOLKSWAGEN	2.0/ 2.4/ 3.2FSI/ 3.0 V6 TDI/ 4.2 V8 TDI/ 2.8/ 1.4/ 1.6 TSI/FSI

Código de motor: BGP/ BGQ/ CBUA/ CBTA/ BPR/ BPS

AL010225
68.00€
Kit comando motores VOLKSWAGEN

Modelo	Motorização	Ano
Transporter	2.4D T4	1995>2003
Código de motor: AAB/ AJA		
Transporter	2.5TDI	1995>2003
Código de motor: ACV/ AHY/ AJT/ AUF/ AXG/ AXL/ AYC		
Crafter	2.5TDI	2006 >2012
Código de motor: BJJ/ BJK/ BJL/ BJM		

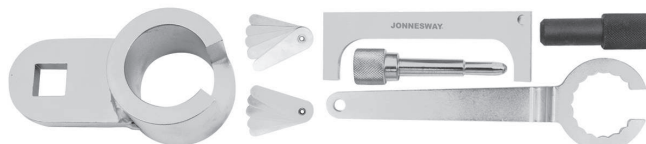

ME010001 355.00€

Jogo de guias para montagem de retentores suspensão

Composição:

Ref.	Compr. (mm)
329-01	449/50
329-02	45
329-03	43
329-04	41
329-05	39
329-06	35/36
329-07	48
329-08	54
329-09	46/47

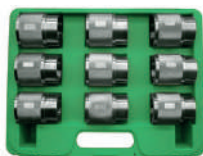

ME010007 28.00€

Chave de montagem/ desmontagem da forqueta invertida

Marca: Kayaba/ Showa



ME010009 9.80€

Saca pip de válvula de ar



ME010010 17.00€

Jogo de guias para casquilhos suspensão

Composição/ medidas (mm):
12,5; 14; 16 e 18



ME010012 28.00€

Guia para montagem/ desmontagem forqueta invertida

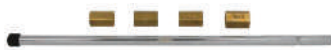

ME020001 31.00€

Removedor do rolamento da coluna da direção

Abertura: 30-68mm



ME020002 52.00€

Ferramenta para instalação rolamento da direção

Diâmetro da haste: 26, 30, 31 e 35mm



ME020003 268.00€

Saca do rolamento da haste da mesa da direção

Medidas (mm): 44, 48 e 51mm



ME020005 76.00€

Guia para instalação do rolamento da direção

Diâmetro da haste: 26, 30, 31 e 35mm



ME020006 220.00€

Dispositivo de instalação das caixas dos rolamentos cónicos na coluna de direção

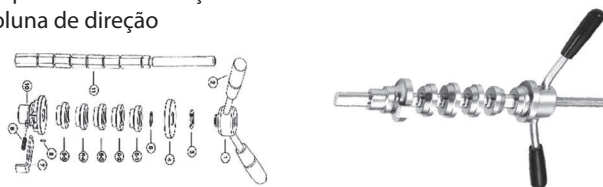

MG010001 28.50€

Saca cubo embraiagem/ polie alternador



MG01000

Chave fêmea da embraiagem

Ref.	Medida (mm)	Pinos	Preço
MG010002	34x59	2	17.50€
MG010003	41x59	2	17.80€
MG010004	39x72	2	20.50€
MG010005	46x72	2	20.50€
MG010006	46	3	20.50€

MG010008 26.00€

Ferramenta para comprimir embraiagem

Para motores 50 a 250cc
com polie de ø125 a 155mm



MG010009 34.00€

Ferramenta para comprimir embraiagem

Para motores 50 a 250cc
com polie de ø125 a 155mm



MG020001

30.50€

Corta corrente

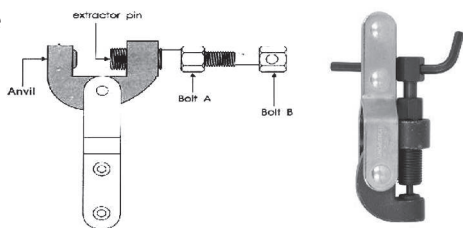

MG020003

66.00€

Corta/ rebitor da corrente



MG020004

10.00€

Alicate para o elo de fecho

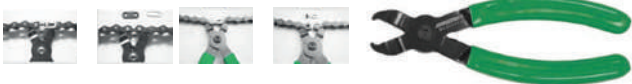

MG020006

13.50€

Ferramenta de fecho da corrente (transmissão ou distribuição)



MG020007

49.80€

Kit limpeza da corrente

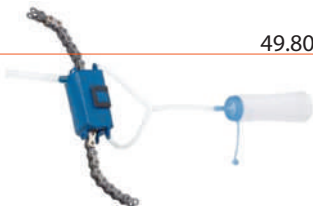

MG020008

12.60€

Escova limpa correntes



MI010014

20.00€

Saca válvulas do motor



MI010016

41.50€

Removedor/ instalador do pino do piston

Medidas (mm):

Pistões: 40 a 100

Pinos: 12 a 25



MI010017

20.70€

Instalador dos segmentos do pistão



MI010018

20.50€

Protetor em alumínio para torno

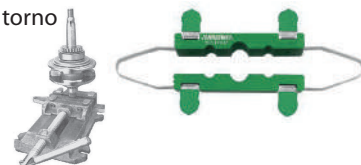

MI010019

170.00€

Ferramenta de auxílio para fecho do motor



MI010020

23.70€

Ferramenta de bloqueio embraiagem/ volante scooter



MI010021

20.80€

Saca para volante magnético



MI020001

11.00€

Chaves para jets 6 e 8mm



MI020002

17.00€

Jogo de chaves para carburadores FCR



MI020004

23.00€

Medidor do nível da altura da bóia do carburador



MN020004

6.60€

Protetor de jantes



MN020005

4.40€

Descolador de pneus



MT010001

8.10€

Oleador de cabos

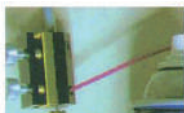

MT010002

42.00€

Ferramenta de furação da fêmea e parafuso de segurança



MT010003

113.00€

Cavalete para roda traseira



MT010004

110.00€

Suporte central universal



MT010005

20.40€

Chave ajustável bloqueio de embraiagem



MT010006

22.70€

Chave ajustável bloqueio de embraiagem



MT010007

33.50€

EZ-ROLL (sistema rotação roda traseira)



MT010008

8.00€

Gancho para molas



CHAPEIRO

AB010001

42.00€

Kit de 10 peças para montagem de vidros



AB010002

70.50€

Kit de remoção para vidros parabrisas



AB010002-A

14.00€

Bobine de arame para remoção de vidros - 15m



AB010017

16.90€

Faca parabrisas

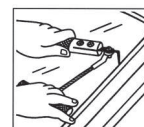

AB0100

Lâmina em aço para faca parabrisas

Ref.	Medida	Preço
AB010018	3/4"	1.70€
AB010019	1"	1.70€
AB010020	1-1/2"	1.70€



AB010026S

28.00€

Removedor de frisos e plásticos



AB010041 38.00€

Jogo de 12 chaves para remoção de painéis



AB010043 49.00€

Espelho auxiliar para reparação de mossas



AB020002 17.90€

Ventosa simples para vidros



AB020003 43.40€

Ventosa dupla para vidros



AB020009 40.00€

Ventosa dupla articulada para vidros

Estrutura em alumínio
Ventosas: ø115mm



AB020010 60.00€

Ventosa tripla para vidros

Estrutura em alumínio
Ventosas: ø123mm
Capacidade: 35 kg/100 kg



AB020015 6.60€

Jogo de ventosas para colocar vidros



Chapeiro

AB020019 35.20€

Jogo de 6 ventosas

Para auxílio durante a colagem de frisos, vidros, etc



AB030001 5.70€

Jogo de 4 espátulas de 25 a 100mm



AB030014 9.00€

Ferramenta para colocação borrachas nos vidros



AB030028 4.00€

Chave para cavilhas e encaixes plásticos



AB030041 4.30€

Chave para cavilhas e encaixes plásticos



AB030043 4.40€

Chave para cavilhas e encaixes plásticos

Encaixe em "V"



AB030046 4.10€

Chave para cavilhas e encaixes plásticos

Encaixe de 8mm



AB030047 3.10€

Chave para cavilhas e encaixes plásticos

Encaixe de 6mm



AB030048 5.90€

Chave para cavilhas e encaixes plásticos



AB030060 38.30€

Jogo de 2 alicates para molas plásticas



AB030068A 27.10€

Alavanca de chapeiro

Medida: 380mm



AB030068C 34.70€

Alavanca de chapeiro

Medida: 900mm



AB030068D 30.70€

Alavanca de chapeiro

Medida: 750mm



AB030068F 19.50€

Alavanca de chapeiro

Medida: 450mm



AB030069A 20.80€

Cunha de chapeiro

Medida: 125mm



AB030069B 26.50€

Cunha de chapeiro

Medida: 137mm



AB030069E 7.30€

Cunha de chapeiro

Medida: 48mm



AB030094J 9.00€

Cunha de chapeiro

Medida: 84,7mm



AB030070B 20.20€

Encontrador de dupla face



AB030070C 17.40€

Encontrador curvo



AB030070D 24.50€

Encontrador tipo vírgula



AB030089 126.50€

Jogo de 7 encontradores para alumínio em polietileno de alta densidade



AB030100 52.00€

Martelo para alumínio com acessórios



AB030071 32.00€

Martelo de cabeça redonda serrilhada



M10110 21.70€

Martelo de cabeça plana redonda e pena pontiaguda



M10210A 17.50€

Martelo de cabeça plana redonda e pena curva



M10210B 17.50€

Martelo de cabeça plana redonda e pena direita



M10410A 24.00€

Martelo de puxar com cabeça redonda plana e quadrada rendilhada picotada



M10410B 24.20€

Martelo de puxar com cabeça redonda plana e quadrada rendilhada normal



AG010023

10.10€

Base para lixa em plástico ABS
Dimensões: 106x212mm



AG010024

27.50€

Armação flexível para lima de chapeiro
Para limas de 355mm

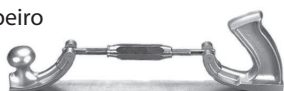

AG010024

Lima para AG010024



Ref.	Serra	Compr.	Preço
AG010024-1	9	14"/355mm	27.50€
AG010024-2	12	14"/355mm	32.50€

AG010030A

145.00€

Jogo de martelos e encontradores



AG010185

89.00€

Alicate de rebordear

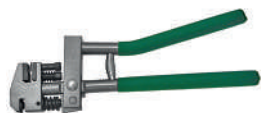

AG010055

20.40€

Desandador de percussão com acessórios



AG010055-B

2.60€

Jogo de 4 bits para AG010055/AG010138

Composição:

Fenda: 8 e 10mm
Philips: PH2 e PH3



AE310003

85.00€

Jogo de tira mossas



Chapeiro

AE330004

59.00€

Pinça de chapeiro uni-direcional
Capacidade: 3t



AE330005

66.00€

Pinça de chapeiro bi-direcional
Capacidade: 2t (transversalmente)
3t (longitudinalmente)



AE330008

52.00€

Pinça de chapeiro bi-direcional
Capacidade: 2t (puxar cruzado)
3t (puxar direito)



AE330009

116.00€

Pinça de chapeiro tipo alicate uni-direcional
Capacidade: 3t



AE330013

120.00€

Pinça de chapeiro bi-direcional
Capacidade: 3t (transversalmente)
5t (longitudinalmente)



AE330015

214.00€

Pinça de chapeiro bi-direcional de 2 pontos
Capacidade: 5t



AE330016

41.50€

Gancho para união de corrente
Capacidade: 6t



AE330030

78.00€

Ponto fixo de puxar
Capacidade: 5t



AE330034

164.00€

Pinça de chapeiro de posição variável até 90°
Capacidade: 5t



Chapeiro

AE330035

86.70€

Pinça de chapeiro
Capacidade: 5t



AG010138

19.40€

Desandador de percussão com 13 bits de 36mm

Phillips: PH1; PH2; PH3 e PH4
Fenda: 5; 6; 8; 10 e 12mm
Hexagonais: 4; 5; 6 e 8mm



AG010138-B

6.70€

Jogo de 13 bits para AG010138/AG010055



AG010140

11.00€

Encontrador múltiplo



AG010141

56.00€

Punho para chapeiro com pontas intermutáveis



AG010142

52.00€

Martelo para chapeiro com pontas intermutáveis



AG010143

57.00€

Punho com punções e escopros intermutáveis



AL010113 30.00€

Chave de 1/2" para rodar cambota

Aplicação: SCANIA



AL010114 40.00€

Chave de 1/2" para alinhar cambota

Aplicação:

Marca Motorização

MERCEDES 6.8/ 10 cilindros

MAN 12 cilindros



AL010116 49.00€

Chave de 11 dentes para alinhar cambota

Medida: Parafuso hexagonal de 24mm

Aplicação: DAF CF65/ CF75/ CF85/

F65/ F75/ F85/ F95/ XF95



AL010117 27.00€

Chave de 1/2" para alinhar cambota

Aplicação: DAF XF105 euro



AN010187 140.00€

Alicate para cintas de travões

Aplicação: VOLVO



AI010153 17.00€

Chave sensor de posição com 8 faces de 1/2"

Não utilizar com máquinas pneumáticas

Medida: 27mm

Comprimento: 60mm

Aplicação: MERCEDES Actros/ série SK/ MAN/ SCANIA



AI020164 26.50€

Chave para válvula eletromagnética com 8 faces de 3/4"

Medida: 38mm

Comprimento: 100mm

Aplicação: SCANIA



AI050135 120.00€

Jogo de chaves de copo para filtros - pesados

Composição:

Chave 6 faces 36mm

Chave 15 faces 74mm

Chave 15 faces 106mm

Chave 15 faces 107mm

Chave 15 faces 108mm

Chave 18 faces 108mm

Chave 18 faces 135mm

Chave de cinta Ø 160mm

Chave 21mm



AI050172 143.00€

Chave de filtros ajustável de 1/2"

Medida: 104-150mm



AN010235 55.00€

Chave de 3/4" para instalação/ remoção de fêmea embraiagem

Diâmetro interno: 64mm

Diâmetro externo: 79mm

Comprimento: 78mm

Espigões: 7mm

Aplicação: SCANIA



AN010237 110.00€

Extrator para articulações tirante de travões

Haldex



AN040062 30.00€

Chave montagem/ desmontagem de injetores

Aplicação: SCANIA/ MERCEDES/ MAN



AN040066 157.00€

Saca rótulas

Medida: 39mm

Aplicação: SCANIA/ MERCEDES/ MAN/ HINO



AN040105 133.00€

Chave para roda traseira com 8 faces de 1"

Medida: 100mm

Aplicação: SCANIA



AN040200 99.00€

Chave cubo para roda dianteira de 1"

Medida: 80mm

Aplicação: SCANIA



AG01016

Chave de rodas dupla

Ref.	Medida (mm)	Dimensão (mm)	Preço
AG010167	24x27	3/4" x 600	40.00€
AG010168	30x32	3/4" x 600	43.00€
AG010169	32x33	3/4" x 600	43.00€



AI050110

46.00€

Chave de filtros de corrente

Comprimento da corrente: 520mm
Filtros: 60-165mm



AN04005

Chave para remoção da tampa do cubo da roda traseira

Ref.	Medida (mm)	Preço
AN040055	111	130.00€
AN040056	120	130.00€



AB030076

Molas de plástico

Ref.	Quant. Embl.	Preço
AB030076-01	300	17.30€
AB030076-02	300	17.30€
AB030076-03	200	17.30€
AB030076-05	150	15.10€
AB030076-06	150	15.10€
AB030076-07	200	17.30€
AB030076-11	200	17.30€
AB030076-13	200	17.30€
AB030076-14	100	18.40€
AB030076-15	100	18.40€
AB030076-17	100	18.40€
AB030076-18	200	17.30€
AB030076-20	200	17.30€
AB030076-21	100	18.60€
AB030076-24	100	18.60€
AB030076-26	100	22.00€
AB030076-27	100	22.00€
AB030076-28	100	22.00€
AB030076-30	100	18.40€
AB030076-32	100	18.40€
AB030076-34	200	31.80€

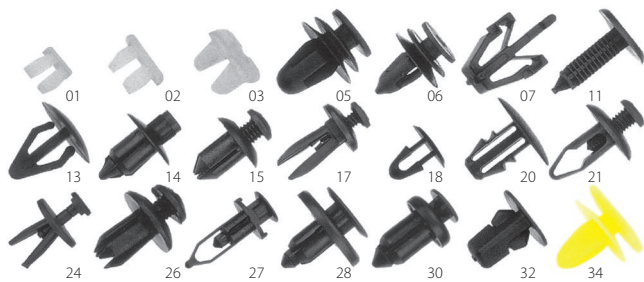

AB030076-00

72.50€

Jogo de 21 tipos de molas com 20 peças de cada
Caixa plástica



AI020158

86.70€

Jogo de 150 anilhas de cobre para injetores com 15 medidas

Composição:

13,85x7,3x1,4; 14,60x7,5x1,3; 14,60x7,5x3,0; 15x7x2;
15x7,5x1; 15x7,5x1,5; 15x7,5x2; 15x7,5x2,5; 15x7,5x3;
15,5x7,5x2; 16x7,5x1,5; 16x7,5x1,7; 16x7,5x2; 16x7,4x2
e 20x9,4x0,9



AR030022

60.20€

Jogo de 530 terminais auto com 18 tipos



AR030024

32.00€

Jogo de 270 vedantes para sistemas A/C

Composição:

4,47x1,78; 5,28x1,78; 6,07x1,78; 6,80x1,90; 7,65x1,78;
8x2; 8,80x1,90; 9,25x1,78; 10,82x1,78; 10,77x2,62;
12x2; 13x2; 13,95x2,62; 14x2; 15x2; 15,54x2,62;
17,17x1,78 e 20,22x3,53





JONNESWAY[®]

Ferramenta Pneumática



**Ferramenta
pneumática**

**Acessórios
para redes de
ar comprimido**



JAI-1024

169.00€

Máquina compacta de impacto de 1/2"

Caraterísticas:

Rotações em vazio:	10 000rpm
Torque trabalho:	510Nm
Torque máximo:	570Nm
Comprimento:	99mm
Peso:	1 400g
Consumo ar:	127l/min
Pressão de funcionamento:	6,2bar
Ruído:	97dB



JAI-1024-RK

9.90€

Kit de reparação para JAI-1024



JAI-1124

175.00€

Máquina compacta de impacto de 1/2"

Máquina ultra leve em compósito com mecanismo de 2 percutores e 3 velocidades de aperto e 1 velocidade de desaperto (potência máxima). Cobertura frontal em liga alumínio resistente.

Caraterísticas:

Rotações em vazio:	9 500rpm
Torque trabalho:	560Nm
Torque máximo:	620Nm
Comprimento:	112mm
Peso:	1 150g
Consumo ar:	136l/min
Pressão de funcionamento:	6,2bar
Ruído:	99,9dB



BREAKAWAY

torque 1 100Nm

JAI-1124-RK

11.50€

Kit de reparação para JAI-1124

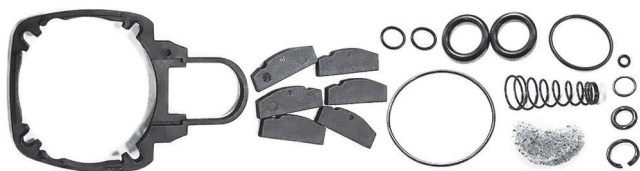

JAI-1114

180.00€

Máquina de impacto de 1/2"

Máquina em compósito preparada para trabalho intensivo com mecanismo de 2 percutores.

Caraterísticas:

Rotações em vazio:	9 500rpm
Torque trabalho:	880Nm
Torque máximo:	1 356Nm
Comprimento:	190mm
Peso:	2 300g
Consumo ar:	207l/min
Pressão de funcionamento:	6,2bar
Ruído:	99,2dB



JAI-1114K

240.00€

Máquina pneumática de impacto de 1/2" com kit de chaves

Máquina em compósito preparada com mecanismo de 2 percutores.

Caraterísticas:

Rotações em vazio:	9 500rpm
Torque trabalho:	880Nm
Torque máximo:	1 356Nm
Comprimento:	190mm
Peso:	2 300g
Interior mangueira:	10mmø
Consumo ar:	207l/min
Ruído:	99,2dB



Acessórios:

- 10 Chaves impacto de 1/2": 9; 10; 11; 13; 17; 19; 22; 24 e 27mm
- 1 Extensão de 125mm
- 1 Kit de manutenção

JAI-1114-RK

13.00€

Kit de reparação para JAI-1114

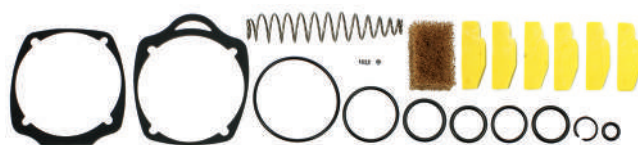

JAI-1524

135.00€

Máquina pneumática de impacto de 1/2"

Máquina em compósito para trabalho intensivo preparada com mecanismo de 2 percutores.

Caraterísticas:

Rotações em vazio:	8 500rpm
Torque trabalho:	840Nm
Torque máximo:	1 080Nm
Comprimento:	190mm
Peso:	2 500g
Interior mangueira:	10mmø
Consumo ar:	125l/min
Ruído:	104,8dB
Posições de aperto:	3
Posições de desaperto:	1



JAI-0954

215.00€

Máquina de impacto de 1/2"

Máquina em compósito preparada com mecanismo de 2 percutores (Twin Hammer).

Caraterísticas:

Rotações em vazio: 8 500rpm
 Torque trabalho: 880Nm
 Torque máximo: 1 356Nm
 Comprimento: 181mm
 Peso: 1 900g



JAI-1232K

152.00€

Máquina para remoção de velas de incandescência de 1/4" com kit de chaves

Máquina com comutador de direção incorporado no botão de acionamento, permitindo efetuar a mudança de direção só com uma mão.
 4 Posições reguláveis para 20; 30; 40 e 45Nm

Caraterísticas:

Rotações em vazio: 11 000rpm
 Torque: 20-45Nm
 Comprimento: 180mm
 Peso: 800g
 Consumo ar: 150l/min
 Pressão de funcionamento: 6,2bar
 Ruído: 102dB

Acessórios:

Chaves caixa longas: 8; 9; 10; 11 e 12mm
 Cardan
 Extensão



JAI-1232-RK

12.50€

Kit de reparação para JAI-1232



JAI-1054

210.00€

Máquina de impacto de 1/2"

Máquina para trabalho intensivo com mecanismo de 2 percutores.

Caraterísticas:

Rotações em vazio: 8 000rpm
 Torque trabalho: 780Nm
 Torque máximo: 920Nm
 Comprimento: 186mm
 Peso: 2 560g
 Interior mangueira: 13mmø
 Consumo ar: 119l/min
 Ruído: 90dB



JAI-1054-RK

22.00€

Kit de reparação para JAI-1054



JAI-1513

225.00€

Máquina pneumática de impacto angular de 3/8"

Caraterísticas:

Rotações em vazio: 6 500rpm
 Torque trabalho: 339Nm
 Torque máximo: 380Nm
 Comprimento: 248mm
 Peso: 1 350g
 Interior mangueira: 10mmø
 Consumo ar: 119l/min
 Ruído: 105dB



JAI-1513-RK

18.50€

Kit de reparação para JAI-1513

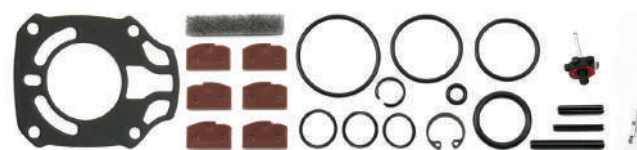

JAI-1514

221.00€

Máquina pneumática de impacto angular de 1/2"

Caraterísticas:

Rotações em vazio: 6 500rpm
 Torque trabalho: 407Nm
 Torque máximo: 460Nm
 Comprimento: 248mm
 Peso: 1 400g
 Interior mangueira: 10mmø
 Consumo ar: 119l/min
 Ruído: 105dB



JAI-1514-RK

19.00€

Kit de reparação para JAI-1514



JAI-0926-RK

38.50€

Kit de reparação para JAI-0926



JAI-0936

580.00€

Máquina de impacto de 3/4"

Máquina em compósito preparada para trabalho intensivo com mecanismo de 2 percutores.

Caraterísticas:

Rotações em vazio:	6 500rpm
Torque trabalho:	1 620Nm
Torque máximo:	2 025Nm
Comprimento:	225mm
Peso:	1 940g
Interior mangueira:	13mmø
Consumo ar:	190l/min
Ruído:	90,5dB



JAI-0936-RK

57.00€

Kit de reparação para JAI-0936



JAI-6212K

390.00€

Máquina de impacto de 3/4" com kit de chaves

Máquina com mecanismo pin clutch.

Caraterísticas:

Rotações em vazio:	4 800rpm
Torque máximo:	1 086Nm
Peso:	4 900g
Interior mangueira:	13mmø

Accessórios:

Chaves: 26-38mm
Kit manutenção
Mala



JAI-6212-RK1

18.00€

Kit de reparação para JAI-6212

JAI-6211

359.00€

Máquina de impacto de 3/4" (19mm)

Máquina com mecanismo de 2 percutores.

Caraterísticas:

Rotações em vazio:	6 500rpm
Torque máximo:	1 016Nm
Peso:	4 550g
Interior mangueira:	13mmø



JAI-6211-RK

32.00€

Kit de reparação para JAI-6211



JAI-1206L

780.00€

Máquina de impacto de 3/4"

Máquina para trabalho intensivo com veio longo e mecanismo de 2 percutores.

Caraterísticas:

Rotações em vazio:	5 500rpm
Torque trabalho:	2 100Nm
Torque máximo:	2 300Nm
Comprimento:	465mm
Peso:	6 400g
Interior mangueira:	19mmø
Consumo ar:	212l/min
Ruído:	106dB

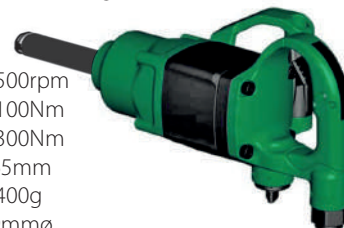

JAI-1206L-RK

53.00€

Kit de reparação para JAI-1206



JAI-0938

655.00€

Máquina de impacto de 1"

Máquina em compósito para trabalho intensivo com mecanismo de 2 percutores.

Caraterísticas:

Rotações em vazio:	6 500rpm
Torque trabalho:	1 740Nm
Torque máximo:	2 150Nm
Comprimento:	230mm
Peso:	4 100g
Consumo ar:	190l/min
Pressão de funcionamento:	6,2bar
Ruído:	190,5dB



JAI-0938-RK

55.50€

Kit de reparação para JAI-0938



JAI-1138

725.00€

Máquina de impacto de 1"

Máquina de veio curto com mecanismo de 2 percutores.

Caraterísticas:

Rotações em vazio: 5 000rpm
 Torque trabalho: 2 430Nm
 Torque máximo: 2 712Nm
 Comprimento: 347mm
 Peso: 7 400g
 Interior mangueira: 19mmø
 Consumo ar: 255l/min
 Ruído: 100dB



JAI-1138-RK

89.00€

Kit de reparação para JAI-1138/ JAI-1138L



JAI-1138L

760.00€

Máquina de impacto de 1"

Máquina de veio longo com mecanismo de 2 percutores.

Caraterísticas:

Rotações em vazio: 5 000rpm
 Torque trabalho: 2 430Nm
 Torque máximo: 2 712Nm
 Comprimento: 487mm
 Peso: 8 300g
 Interior mangueira: 19mmø
 Consumo ar: 255l/min
 Ruído: 100dB



JAI-1408

1 165.00€

Máquina de impacto pesados de 1"

Máquina de veio curto.

Caraterísticas:

Rotações em vazio: 4 800rpm
 Torque trabalho: 3 270Nm
 Torque máximo: 3 520Nm
 Comprimento: 370mm
 Peso: 10 500g
 Consumo ar: 450l/min
 Pressão de funcionamento: 6,3bar
 Ruído: 105,5dB



JAI-1408-RK

73.50€

Kit de reparação para JAI-1408/ JAI-1408L



JAI-1408L

1 250.00€

Máquina de impacto pesados de 1"

Máquina de veio longo.

Caraterísticas:

Rotações em vazio: 4 800rpm
 Torque trabalho: 3 270Nm
 Torque máximo: 3 520Nm
 Comprimento: 570mm
 Peso: 11 900g
 Consumo ar: 450l/min
 Pressão de funcionamento: 6,3bar
 Ruído: 105,5dB



JAI-6202-RK

54.50€

Kit de reparação para JAI-6202



JAI-0501-RK

18.80€

Kit de reparação para JAI-0501



JAR-1012

78.50€

Roquete pneumático de 1/4"

Caraterísticas:

Rotações em vazio: 230rpm
 Torque máximo: 40Nm
 Comprimento: 140mm
 Peso: 469g
 Interior mangueira: 10mmø
 Consumo ar: 338l/min



JAR-1012-RK

30.00€

Kit de reparação para JAR-1012



JAR-1013

82.00€

Roquete pneumático de 3/8"

Caraterísticas:

Rotações em vazio: 230rpm
 Torque máximo: 40Nm
 Comprimento: 140mm
 Peso: 469g
 Interior mangueira: 10mmø
 Consumo ar: 338l/min



JAR-1013-RK

30.00€

Kit de reparação para JAR-1013



JAR-1094

105.00€

Roquete pneumático de 1/2"

Caraterísticas:

Rotações em vazio: 170rpm
 Torque máximo: 100Nm
 Comprimento: 275mm
 Peso: 1 400g
 Interior mangueira: 10mmø
 Consumo ar: 113l/min
 Ruído: 87dB



JAR-1094-RK

33.00€

Kit de reparação para JAR-1094



JAR-6309AK

127.00€

Roquete pneumático de 1/2" com kit de chaves

Caraterísticas:

Rotações em vazio: 170rpm
 Torque máximo: 100Nm
 Comprimento: 275mm
 Peso: 1 400g
 Interior mangueira: 10mmø



Acessórios:

Chaves: 9; 10; 11; 13; 14; 17 e 19mm
 Extensão: 75mm
 União universal de 1/2"
 Bits e porta bits
 Mala



JAR-6309A-RK

26.00€

Kit de reparação para JAR-6309A

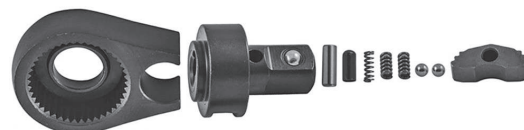

JAR-6310A

93.00€

Roquete pneumático de 3/8"

Caraterísticas:

Rotações em vazio: 170rpm
 Torque máximo: 100Nm
 Comprimento: 275mm
 Peso: 1 300g
 Interior mangueira: 10mmø



JAR-6310A-RK

25.00€

Kit de reparação para JAR-6310A



JAR-6310AK

125.00€

Roquete pneumático de 3/8" com kit de chaves

Caraterísticas:

Rotações em vazio: 170rpm
 Torque máximo: 100Nm
 Comprimento: 275mm
 Peso: 1 300g
 Interior mangueira: 10mmø



Acessórios:

Chaves: 9; 10; 11; 13; 14; 17 e 19mm
 Extensão: 75mm
 União universal de 3/8"
 Bits e porta bits
 Mala



JAR-1033

270.00€

Roquete pneumático combinado de 3/4" com kit de chaves

Caraterísticas:

Rotações em vazio: 180rpm
 Torque máximo: 107Nm
 Comprimento: 9,5mm
 Peso: 1 400g
 Interior mangueira: 10mmø



Acessórios:



Chaves: 8 a 19mm
 Adaptadores

JAR-1033-RK

69.00€

Kit de reparação para JAR-1033A



JAD-0212

105.00€

Berbequim pneumático de 1/4"

Máquina em compósito.

Caraterísticas:

Rotações em vazio: 1 800rpm
 Potência: 2cv
 Comprimento: 199mm
 Peso: 780g
 Interior mangueira: 10mmø
 Consumo ar: 54,4l/min
 Ruído: 97dB



JAD-0413

107.00€

Berbequim reversível pneumático de 3/8"

Caraterísticas:

Rotações em vazio: 1 800rpm
 Motor: 0,4cv
 Capacidade da bucha: 10mm
 Comprimento: 210mm
 Peso: 950g
 Interior mangueira: 10mmø
 Consumo ar: 99l/min
 Vibração: 3,3m/s²
 Ruído: 80dB



JAD-0413-RK

11.00€

Kit de reparação para JAD-0413



JAD-1020

103.00€

Berbequim reversível pneumático de 1/2"

Caraterísticas:

Rotações em vazio: 800rpm
 Capacidade da bucha: 13mm (aperto com chave)
 Comprimento: 220mm
 Peso: 1 300g
 Interior mangueira: 10mmø



JAD-1020-RK

2.30€

Kit de reparação para JAD-1020



JAD-1021

106.00€

Berbequim pneumático angular de 3/8"

Caraterísticas:

Rotações em vazio: 1 900rpm
 Capacidade da bucha: 10mm (aperto com chave)
 Comprimento/ altura: 190x110mm
 Peso: 960g
 Interior mangueira: 10mmø
 Consumo ar: 280l/min



JAD-1021-RK

12.50€

Kit de reparação para JAD-1021



JAD-1027

125.00€

Berbequim reversível pneumático de 1/2"

Caraterísticas:

Rotações em vazio: 800rpm
 Capacidade da bucha: 13mm (aperto sem chave)
 Comprimento: 178mm
 Peso: 1 820g
 Interior mangueira: 10mmø



JAD-1027-RK

2.20€

Kit de reparação para JAD-1027



JAD-6252A 65.00€

Berbequim pneumático de 3/8"

Caraterísticas:
 Rotações em vazio: 2 500rpm
 Capacidade da bucha: 9,5mm (aperto com chave)
 Comprimento: 228mm
 Peso: 900g
 Interior mangueira: 10mmø



JAD-6252A-RK 3.60€

Kit de reparação para JAD-6252



JAB-1017 95.00€

Aparafusadora pneumática reversível de 1/4"

Caraterísticas:
 Rotações em vazio: 1 800rpm
 Capacidade da bucha: 1/4"
 Comprimento: 190mm
 Peso: 1 100g
 Interior mangueira: 10mmø



JAB-1017-RK 1.90€

Kit de reparação para JAB-1017



JAB-1018 108.00€

Aparafusadora pneumática reversível de 1/4"

Caraterísticas:
 Rotações em vazio: 800rpm
 Capacidade da bucha: 1/4"
 Comprimento: 226mm
 Peso: 1 300g
 Interior mangueira: 10mmø



JAB-1018-RK 1.90€

Kit de reparação para JAB-1018



JAB-7003A 114.00€

Aparafusadora pneumática reversível de 1/4"

Caraterísticas:
 Rotações em vazio: 1 800rpm
 Capacidade da bucha: 1/4"
 Comprimento: 254mm
 Peso: 1 140g
 Interior mangueira: 10mmø



JAB-7003A-RK 4.20€

Kit de reparação para JAB-7003A



JAD-1015K 317.00€

Máquina pneumática de descravar pontos com kit de acessórios

Caraterísticas:
 Rotações em vazio: 1 800rpm
 Capacidade de furo: 8mm
 Comprimento: 254mm
 Peso: 2 100g
 Interior mangueira: 10mmø



Acessórios:



Chave hexagonal: 2,5mm
 Brocas
 Lubrificador
 Ligador: 1/4"x1/4"
 Mala

JAD-1015-RK 2.40€

Kit de reparação para JAD-1015K



JAZ-7207 75.00€

Jogo de 5 brocas para máquina descravar

Aplicável aos modelos: JAD-1015/ JAD-6246

Caraterísticas:
 Brocas em HSS e cobalto
 Diâmetro: 6,5mmø



JAG-0903-MS 12.50€

Jogo de 10 buris

Aplicável aos modelos:
 JAG-0903/ JAG-0906/ JAG-0913/ JAG-0923/ JAG-0925/ JAG-0955



JAG-0906RMK

77.00€

Retificadora pneumática de 1/4" com kit de acessórios

Caraterísticas:

Rotações em vazio:	22 000rpm
Capacidade da pinça:	6mm
Potência:	0,4Kw
Comprimento:	175mm
Peso:	490g
Interior mangueira:	10mmø

Acessórios:

Buris: 6mm (1/4")
Buris: 3mm (1/8")
Chaves
Redução: 3mm (1/8")
Mala



JAG-0906R/RM-RK

7.50€

Kit de reparação para JAG-0906RMK



JAG-0913RMK

98.00€

Retificadora pneumática angular de 1/4" com kit acessórios

Caraterísticas:

Rotações em vazio:	18 000rpm
Capacidade da pinça:	6mm
Potência:	0,21Kw
Comprimento:	155mm
Peso:	490g
Interior mangueira:	10mmø

Acessórios:

Buris: 6mm (1/4")
Buris: 3mm (1/8")
Chaves
Redução: 3mm (1/8")
Mala



JAG-0913RM-RK

5.30€

Kit de reparação para JAG-0913RMK



JAG-0923RM

48.00€

Mini retificadora pneumática de 1/4"

Caraterísticas:

Rotações em vazio:	25 000rpm
Capacidade da pinça:	6mm
Potência:	0,5hp
Comprimento:	170mm
Peso:	700g
Consumo ar:	76l/min
Pressão de funcionamento:	6,2bar
Ruído:	97dB



JAG-0923RM-RK

5.90€

Kit de reparação para JAG-0923RM



JAG-0925RM

50.00€

Retificadora pneumática de 1/4"

Caraterísticas:

Rotações em vazio:	22 000rpm
Capacidade da pinça:	6mm
Potência:	0,5hp
Comprimento:	170mm
Peso:	700g
Consumo ar:	113l/min
Pressão de funcionamento:	6,2bar
Ruído:	97dB



JAG-0925RM-RK

16.50€

Kit de reparação para JAG-0925RM



JAG-0955RM

80.00€

Retificadora pneumática de 1/4"

Caraterísticas:

Rotações em vazio:	22 000rpm
Capacidade da pinça:	6mm
Potência:	0,5hp
Comprimento:	260mm
Peso:	700g
Consumo ar:	113l/min
Pressão de funcionamento:	6,2bar
Ruído:	97dB



JAG-0955RM-RK

6.70€

Kit de reparação para JAG-0955RM



JAG-1087 140.00€

Micro retificadora pneumática

- Caraterísticas:
- Rotações em vazio: 60 000rpm
 - Bucha: 3mm
 - Interior mangueira: 10mmø
 - Peso: 220g
 - Consumo ar: 180l/min
 - Dimensões: 17x120mm



JAG-1087-RK 25.50€

Kit de reparação para JAG-1087



JAG-6638 138.00€

Rebarbadora pneumática angular de 125mm

- Caraterísticas:
- Rotações em vazio: 11 000rpm
 - Dimensão do disco: 125mm
 - Potência: 0,7Kw
 - Comprimento: 230mm
 - Peso: 1 800g
 - Interior mangueira: 10mmø
 - Vibração do punho: 6,45m/s²
 - Ruído: 86dB



JAG-6638-RK 64.00€

Kit de reparação para JAG-6638



JAG-6639 283.00€

Rebarbadora pneumática angular de 180mm

- Caraterísticas:
- Rotações em vazio: 7 000rpm
 - Dimensão do disco: 180mm (7")
 - Potência: 1,4Kw
 - Comprimento: 343mm
 - Peso: 3 100g
 - Interior mangueira: 10mmø



JAG-6639-RK 85.00€

Kit de reparação para JAG-6639



JAS-6505 125.00€

Lixadora de disco de 180mm

- Caraterísticas:
- Rotações em vazio: 4 500rpm
 - Dimensão do disco: 178mm
 - Rosca do veio: 5,8" (11UNC)
 - Comprimento: 406mm
 - Peso: 2 500g
 - Interior mangueira: 10mmø



JAS-6505-RK 5.50€

Kit de reparação para JAS-6505



JAS-6551 128.00€

Lixadora de disco de 180mm

- Caraterísticas:
- Rotações em vazio: 2 500rpm
 - Dimensão do disco: 178mm
 - Rosca do veio: 5,8" (11UNC)
 - Comprimento: 406mm
 - Peso: 2 500g
 - Interior mangueira: 10mmø



JAS-6551-RK 5.50€

Kit de reparação para JAS-6551



JAS-6552 125.00€

Polidora pneumática de 180mm

- Caraterísticas:
- Rotações em vazio: 2 500rpm
 - Dimensão do disco: 178mm
 - Peso: 2 800g
 - Interior mangueira: 10mmø
 - Consumo ar: 260l/min



JAS-6552-RK 16.00€

Kit de reparação para JAS-6552



JAS-0010

212.00€

Lixadora com base triangular em vinil

Características:

Rotações em vazio:	9 000rpm
Dimensão da base:	93x132mm
Interior mangueira:	10mmø
Consumo ar:	260l/min

JAS-0010-RK

21.00€

Kit de reparação para JAS-0010

JAS-0010-41

19.40€

Base para lixadora JAS-0010

Dimensão da base: 93x132mm

JAS-0413

120.00€

Lixadora orbital angular

Máquina em compósito

Características:

Rotações em vazio:	15 000rpm
Dimensão do disco:	76mm
Órbita:	3mm
Motor:	0,4cv
Comprimento:	125mm
Peso:	720g
Interior mangueira:	10mmø
Consumo ar:	99l/min
Vibração:	6,3m/s ²
Ruído:	80dB

JAS-0413-RK

9.50€

Kit de reparação para JAS-0413

JAS-0423K

152.00€

Polidora angular

Máquina em compósito

Características:

Rotações em vazio:	2 100rpm
Dimensão do disco:	76mm
Motor:	0,4cv
Comprimento:	135mm
Peso:	770g
Consumo ar:	99l/min
Pressão de funcionamento:	6,2bar
Vibração:	2,3m/s ²
Ruído:	78dB

JAS-0423-RK

21.00€

Kit de reparação para JAS-0423

JAS-1021-6HE(2.5)

195.00€

Lixadora orbital angular com base em vinil aderente com 6"

Máquina em compósito

Características:

Rotações em vazio:	12 000rpm
Dimensão do disco:	150mm
Órbita:	2,5mm
Peso:	960g
Interior mangueira:	10mmø
Consumo ar:	170l/min

JAS-1021-6HE-RK

9.60€

Kit de reparação para JAS-1021-6HE

JAS-1206-6HE

299.00€

Lixadora orbital para ligação a central de aspiração com base em vinil aderente com 6"

Máquina em compósito

Características:

Rotações em vazio:	12 000rpm
Dimensão do disco:	150mm
Órbita:	5mm
Interior mangueira:	10mmø

JAS-1206-6HE-RK

43.00€

Kit de reparação para JAS-1206-6HE

JAS-1206-6HP

47.00€

Base com velcro para lixadora JAS-1206/ JAS-1207 com 6"



JAS-1207-6HE

355.00€

Lixadora orbital com auto aspiração com base em vinil aderente com 6"

Máquina em compósito

Caraterísticas:

Rotações em vazio: 12 000rpm
 Dimensão do disco: 150mm
 Órbita: 5mm
 Interior mangueira: 10mmø
 Saco para recolha de pó



JAS-1207-6HE-RK

43.00€

Kit de reparação para JAS-1207-6HE



JAS-1207-6HE-56

25.00€

Saco em tecido para proteção do saco papel de recolha de pó para JAS-1207-6HE.



JAS-1207-6HE-57

3.20€

Saco em papel para recolha de pó para JAS-1207-6HE



JAS-1206-6HP

47.00€

Base com velcro para lixadora JAS-1206/ JAS-1207 com 6"



JAS-1031-6HE

201.00€

Lixadora orbital com base em velcro com 6"

Máquina em compósito

Caraterísticas:

Rotações em vazio: 10 000rpm
 Dimensão do disco: 150mm
 Órbita: 5mm
 Peso: 1 040g
 Interior mangueira: 10mmø



JAS-1031-6HE-RK

45.00€

Kit de reparação para JAS-1031-6HE

JAS-1031-6VE-RK

45.00€

Kit de reparação para JAS-1031-6VE

JAS-1031-6HP

21.00€

Base em velcro para lixadora JAS-1031/ JAS 6535-6HE



JAS-6531

135.00€

Lixadora retangular estreita

Máquina em compósito

Caraterísticas:

Movimentos/ minuto: 2 500
 Dimensão da base: 63,5x407mm
 Comprimento: 406mm
 Peso: 3 100g
 Interior mangueira: 10mmø
 Consumo ar: 226l/min
 Ruído: 93,3dB



JAS-6531-RK

2.40€

Kit de reparação para JAS-6531

JAS-6535-5HE

182.00€

Lixadora orbital com base em velcro com 5"

Máquina em compósito

Caraterísticas:

Rotações em vazio: 10 000rpm
 Dimensão do disco: 125mm
 Órbita: 5mm
 Peso: 1 040g
 Interior mangueira: 10mmø



JAS-6535-5HE-RK

47.50€

Kit de reparação para JAS-6535-5HE

JAS-6535-5HE-47

19.00€

Base em velcro para JAS-6535-5HE

JAS-6535-5VE-RK

35.50€

Kit de reparação para JAS-6535-5VE

JAS-6535-6HE

175.00€

Lixadora orbital com base em velcro com 6" Máquina em compósito

Características:

Rotações em vazio: 10 000rpm
 Dimensão do disco: 150mm
 Órbita: 5mm
 Peso: 1 040g
 Interior mangueira: 10mmø

JAS-6535-6HE-RK

45.00€

Kit de reparação para JAS-6535-6HE

JAS-1031-6HP

21.00€

Base em velcro para lixadora JAS-1031/ JAS 6535-6HE

JA-6111(1.4)

100.00€

Pistola de pintura tipo gravidade

Características:

Entrada ar: 1/4"
 Capacidade copo nylon: 600ml
 Bico standard: 1,4mm

JA-6111

Kit de bico para pistola JA-6111

Ref.	Medida (mm)	Preço
JA-6111-NS13	1.3	38.50€
JA-6111-NS17	1.7	38.50€
JA-6111-NS20	2	38.50€

JA-6111K

215.00€

Jogo de pistola de pintura tipo gravidade e acessórios

Características:

Pistola: JA-6111
 Capacidade copo nylon: 250 e 600 ml
 Bicos: 1,7 e 2mm
 Interior mangueira: 10mmø
 Kit de limpeza
 Mala

JA-HVLP-1080GK

280.00€

Jogo de pistola de pintura HVLP e acessórios

Características:

Pistola: JA-HVLP-1 080G
 Capacidade copo nylon: 250 e 600ml
 Bicos: 1,4; 1,7 e 2mm
 Interior mangueira: 10mmø
 Kit de limpeza
 Mala

JA-HVLP-1080GD-N1.4

52.00€

Bico de 1.4 para pistola JA-HVLP-1 080GD

JA-HVLP-300C (1.3)

165.00€

Pistola de pintura tipo gravidade

Características:

Entrada ar: 1/4"
 Capacidade copo nylon: 600 ml
 Bico standard: 1,3mm
 Pressão ar: 2bar
 Consumo ar: 481l/min
 Peso: 545g
 Interior mangueira: 10mmø

JA-HVLP-3000-NS17

61.50€

Kit bico 1.7 para pistola de pintura

JA-HVLP-3000-NS19

61.50€

Kit bico 1.9 para pistola de pintura

JA-300C-NS13

61.00€

Bico completo 1.3 para pistola de pintura JA-HVLP3000/ JA-HVLP300C



JA-LVLP-0303W 165.00€

Pistola de pintura para tintas à base de água tipo gravidade

Caraterísticas:

- Entrada ar: 1/4"
- Capacidade copo nylon: 600ml
- Bico standard: 1,3mm
- Interior mangueira: 10mmø



JA-LVLP-0303W-N 48.50€

Kit bico 1.3 para pistola de pintura



JA-LVLP-0303W-N18 48.50€

Kit bico 1.8 para pistola de pintura

JA-HVLP-6112 148.00€

Pistola de pintura tipo gravidade

Caraterísticas:

- Entrada ar: 1/4"
- Capacidade copo nylon: 125ml
- Bico standard: 1mm
- Pressão ar: 3bar
- Consumo ar: 112l/min
- Peso: 240g
- Interior mangueira: 10mmø



ACC-609 20.40€

Regulador de ar 0-10 bar



JA-3806C 10.00€

Regulador de pressão para pistola de pintura

Aplicável à pistola JA-HVLP-6112



JA-3808A 9.90€

Separador de óleo/ água para pistolas de pintura



JA-0001RK 5.30€

Kit de reparação para pistola de pintura



AS-0026 11.50€

Kit de limpeza para pistolas de pintura com 12 peças

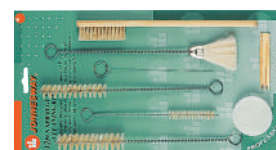

AS-0013A2 25.50€

Copo de alumínio para pistola de pintura tipo gravidade

Capacidade: 600ml



AS-001

Copo para pistola de pintura

Ref.	Capacidade (ml)	Preço
AS-0013	600	12.00€
AS-0015	125	9.00€



JA-300C-28 12.00€

Copo para pistola de pintura JA-HVLP-3000

Capacidade: 600ml

Tampa não incluída



AS-001

Tampa para copo de pistola de pintura

Ref.	Capacidade (ml)	Preço
AS-0013C	600	2.50€
AS-0015C	250	2.40€



JA-950

65.00€

Pistola de secagem para tintas à base de água



JA-950-04

3.00€

Filtro de rede para pistola JA-950

JA-960

183.00€

Suporte para 2 pistolas de secagem
Não inclui as pistolas



JAS-0452

185.00€

Lixadora de faixa larga
Máquina em compósito

Caraterísticas:

Rotações em vazio: 16 000rpm
Dimensão da base: 20x520mm
Comprimento: 430mm
Peso: 1 400g
Interior mangueira: 10mmø
Consumo ar: 113l/min
Vibração: 2,8m/s²
Ruído: 95dB



JAS-0452-RK

34.00€

Kit de reparação para JAS-0452

JAS-6542

182.00€

Lixadora de faixa larga

Caraterísticas:

Rotações em vazio: 16 000rpm
Dimensão da base: 20x520mm
Comprimento: 360mm
Peso: 1 200g
Interior mangueira: 10mmø



JAS-6542-RK

24.00€

Kit de reparação para JAS-6542

Ferramenta pneumática

JAS-6543

110.00€

Lixadora de faixa estreita

Caraterísticas:

Rotações em vazio: 16 000rpm
Dimensão da base: 10x330mm
Comprimento: 290mm
Peso: 800g
Interior mangueira: 10mmø



JAS-6543-RK

19.50€

Kit de reparação para JAS-6543

JAT-1020K

245.00€

Serra/ lima pneumática de baixa vibração com kit de acessórios
Mecanismo de baixa vibração

Caraterísticas:

Oscilação por minuto: 16 000bpm
Curso: 25mm
Peso: 960g
Interior mangueira: 10mmø



Acessórios:



Lâminas: T14, T18 e T24
Limas
Mala

JAT-1020-RK

55.00€

Kit de reparação para JAT-1020

JAT-12F

Limas para JAT-1020

Ref.	Forma	Preço
JAT-12F1	triangular	5.80€
JAT-12F2	meia cana	6.20€
JAT-12F3	redonda	5.80€
JAT-12F4	chata	5.80€



JAT-20T

Serras para JAT-1020

Ref.	Dentes	Preço
JAT-20T14	14	4.10€
JAT-20T18	18	4.10€
JAT-20T24	24	4.10€



JAT-1041 165.00€

Assentador pneumático de válvulas

- Caraterísticas:
 Oscilação por minuto: 3 000bpm
 Capacidade máxima: 4,5mmø
 Comprimento: 153,5mm
 Peso: 1 550g
 Interior mangueira: 10mmø
 Consumo ar: 100l/min
 Ventosas: 16; 20; 30 e 35mm



JAT-1041-16S 15.50€

Jogo de 4 ventosas para JAT-1041

- Caraterísticas:
 Medidas: 16; 20; 30 e 35mm



JAT-1011 137.00€

Serra pneumática de baixa vibração

- Caraterísticas:
 Oscilação por minuto: 11 000bpm
 Curso: 8mm
 Peso: 450g
 Interior mangueira: 10mmø
 Consumo ar: 90l/min
 Ruído: 86,8dB



JAT-1011-RK 25.00€

Kit de reparação para JAT-1011

JAT-6613 185.00€

Máquina pneumática de decapar

- Caraterísticas:
 Diâmetro base: 105mm
 Rotações em vazio: 3.500rpm
 Entrada ar: 1/4"
 Dimensões (comp/alt): 203x106mm
 Peso: 960g
 Consumo ar: 280l/min
 Ruído: 98dB



JAT-6613-P 14.00€

Disco de borracha para JAT-6613



JAT-6613-PA 15.20€

Disco abrasivo de limpeza para JAT-6613



JAT-6613-RK 24.00€

Kit de reparação para JAT-6613

JAT-6676 113.00€

Serra pneumática

- Caraterísticas:
 Capacidade de corte: 1,6mm (espessura aço)
 Oscilação por minuto: 10 000bpm
 Curso: 10mm
 Comprimento: 235mm
 Peso: 960g
 Interior mangueira: 10mmø



JAT-6676-RK 7.00€

Kit de reparação para JAT-6676

JAT-10T

Serras para JAT-6676 5 unidades

Ref.	Dentes	Compr. (mm)	Preço
JAT-10T18	18	75	13.00€
JAT-10T32	32	75	13.00€



JAT-6421 46.50€

Máquina de corte pneumática de discos com 3"

- Caraterísticas:
 Rotações em vazio: 20 000rpm
 Peso: 1 040g
 Interior mangueira: 10mmø



JAT-6421-RK 2.40€

Kit de reparação para JAT-6421

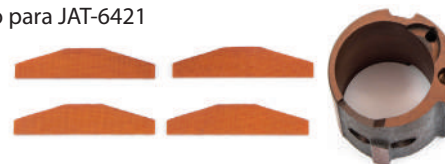

JAT-6421-33 1.30€

Disco de serra para JAT-6421

JAT-6441K 130.00€

Faca pneumática com kit de acessórios
Caraterísticas:

Oscilação por minuto: 22 000bpm
 Comprimento: 120mm
 Peso: 1 200g
 Interior mangueira: 10mmø

Acessórios:

Lâminas: 30; 35 e 57mm
 Mala

JAT-6441-RK 1.50€

Kit de reparação para JAT-6441
CF-K
Lâminas para JAT-6441K

Ref.	Compr. (mm)	Preço
CF-K-C	35	9.50€
CF-K-E	57	7.50€
CF-K-F	90	20.20€
CF-K-G	24	12.70€
CF-K-I	36	15.50€
CF-K-J	63	18.00€

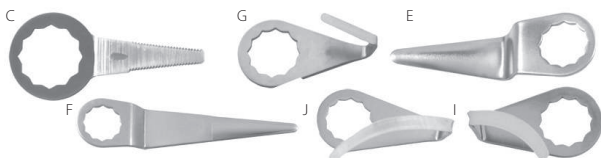
JAT-6952 85.00€

Tesoura pneumática direita
Caraterísticas:

Oscilação por minuto: 2 300/ 2 500bpm
 Capacidade de corte: 1,2mm (espessura aço)
 Tamanho do corte: 5,5mm
 Comprimento: 255mm
 Peso: 1 000g
 Interior mangueira: 10mmø

Acessórios:

Lâminas: 30; 35 e 57mm

JAT-6952-RK 1.50€

Kit de reparação para JAT-6952
JAT-6952P 93.00€

Tesoura pneumática
Caraterísticas:

Oscilação por minuto: 2 200bpm
 Capacidade de corte: 1,2mm (espessura aço)
 Tamanho do corte: 5,5mm
 Comprimento: 215mm
 Peso: 1 200g
 Interior mangueira: 10mmø

JAT-6952P-RK 1.50€

Kit de reparação para JAT-6952P
JAT-6952P
Lâminas para JAT-6952/P

Ref.	Lâmina	Preço
JAT-6952P-37	esquerda	9.20€
JAT-6952P-39	central	11.70€
JAT-6952P-40	direita	9.20€

JAT-6943A 109.00€

Alicate pneumático de rebaiços
Caraterísticas:

Capacidade de corte: 1,4mm
 Capacidade de rebaiço: 8mm
 Quinagem: 12mm
 Comprimento: 248mm
 Peso: 1 300g
 Interior mangueira: 10mmø

JAT-6943A-RK 8.00€

Kit de reparação para JAT-6943A
JAT-6412 64.00€

Reboreadora pneumática
Caraterísticas:

Velocidade de corte: 3 200rpm
 Capacidade de corte: 1,4mm (espessura aço)
 Comprimento: 210mm
 Peso: 1 000g
 Interior mangueira: 10mmø

JAT-6412-RK 1.50€

Kit de reparação para JAT-6412

JAH-0288 108.00€

Martelo pneumático de agulhas

Caraterísticas:
 Pancadas por minuto: 5 000
 Número de agulhas: 12
 Comprimento: 290mm
 Peso: 1 200g
 Consumo ar: 90l/min
 Interior mangueira: 10mmø



JAH-0288-15 12.80€

Cinzel para JAH-0288

JAH-0288-16 7.00€

Jogo de agulhas para JAH-0288

JAH-0288-17 5.60€

Alojamento de agulhas para JAH-0288

JAH-0288-RK 23.50€

Kit de reparação para JAH-0288

JAH-6837 143.00€

Martelo burilador direito

Caraterísticas:
 Golpes por minuto: 4 600
 Encaixe: 25,4x43,5
 Comprimento: 380mm
 Peso: 2 100g
 Interior mangueira: 10mmø



JAH-6837-RK 18.50€

Kit de reparação para JAH-6837

JAH-6837-5

Cinzel para JAH-6837

Ref.	Tipo	Compr. (mm)	Preço
JAH-6837-50	plano	35-175	17.00€
JAH-6837-50-2	ponteiro		16.50€

JAH-7104H 326.50€

Martelo pneumático de 1"

Caraterísticas:
 Golpes por minuto: 2 820
 Comprimento: 308mm
 Peso: 5 500g
 Consumo ar: 228l/min
 Interior mangueira: 10mmø



JAH-7104H-RK 5.50€

Kit de reparação para JAH-7104H

JAZ-01

Buril hexagonal

Ref.	Tipo	Preço
JAZ-011H	bico	19.50€
JAZ-016H	ponta	19.50€

JAT-6034 97.00€

Rebitadora pneumática

Caraterísticas:
 Capacidade: 2,4 a 4,8mm (aço+aço inox)
 Potência tração: 10 250Nm
 Curso: 16mm
 Comprimento: 308mm
 Peso: 1 500g
 Interior mangueira: 10mmø



JAT-6034-RK 21.60€

Kit de reparação para JAT-6034



JAT-6034

Bicos para rebitadora JAT-6034

Ref.	Diâmetro (mm)	Preço
JAT-6034-1A	4,8	1.10€
JAT-6034-1B	4	1.10€
JAT-6034-1C	3,2	1.10€
JAT-6034-1D	2	1.10€



JAT-6673 265.00€

Rebitadora pneumática

Caraterísticas:
 Capacidade: 2,4 a 6,4mm (aço+aço inox)
 Curso: 18mm
 Peso: 1 750g
 Consumo ar: 2,9l/ciclo
 Interior mangueira: 10mmø



JAT-6673-RK 53.00€

Kit de reparação para JAT-6673



JAT-1035

395.00€

Rebitadora pneumática de fêmeas

Caraterísticas:

Dimensões: 270x190mm
 Capacidade: M4-M10 (aço)
 Capacidade: M4-M8 (aço inox)
 Curso: 6mm
 Peso: 1 550g
 Consumo ar: 1,5l/ciclo
 Interior mangueira: 10mmø



JAT-1035-RK

6.70€

Kit de reparação para JAT-1035

JAT-460

23.50€

Bomba de massa manual de ponteira rígida

Acionamento por alavanca

Capacidade: 400cc



JAT-480

31.00€

Bomba de massa manual de ponteira flexível

Acionamento por pistoleta

Capacidade: 400cc



JAT-480-NS

9.00€

Ponteira flexível para JAT-480



JAT-6004K

59.00€

Bomba de massa pneumática de ponteira rígida com acessórios

Acionamento por pneumático

Capacidade: 400cc

Acessórios:



Ponteira flexível
 Alavanca por acionamento manual

JAT-501

53.50€

Pistola pneumática para mastique

Caraterísticas:

Entrada: 1/4"
 Capacidade: 310ml
 Pressão: 2,5 a 5,1bar
 Interior mangueira: 10mmø
 Cartucho tipo "Salsichão"



JA-5032

34.50€

Pistola pneumática para mastique

Caraterísticas:

Pressão: 2 a 4bar
 Comprimento: 330mm
 Peso: 1 225g
 Consumo ar: 170l/min
 Interior mangueira: 10mmø
 Material: metal



JAZ-3811E

59.00€

Balaceiro

Caraterísticas:

Capacidade de carga: 3 a 5kg
 Comprimento do fio: 1,5mt
 Diâmetro do fio: 3,2mm



JA-3812A

38.00€

Balaceiro

Caraterísticas:

Capacidade de carga: 0,5 a 1,2kg
 Comprimento do fio: 1,6m
 Diâmetro do fio: 1,8mm
 Peso: 560g



JA-3812D

40.00€

Balaceiro

Caraterísticas:

Capacidade de carga: 1 a 2kg
 Comprimento do fio: 1,6m
 Diâmetro do fio: 1,8mm
 Peso: 560g



JAT-6904S

17.00€

Pistolete para água com kit de acessórios com 5 bicos



JAT-6905B

15.00€

Pistolete de ar



JAT-6905S

29.80€

Pistolete de ar com conjunto de acessórios



JAT-6905-C

3.00€

Bico para pistolete de ar
Bico triangular espolado



JAT-6905-J

10.80€

Bico para pistolete de ar
Bico com escova em nylon



JAT-6959

5.50€

Pistola para ar de bico longo de 1/4"

Comprimento: 100mm
Pressão trabalho: 75-120psi
Ruído: 85-90dba
Fêmea: 1/4"



JAT-6959A

6.80€

Pistola para ar de bico longo de 1/4"

Comprimento: 280mm
Pressão trabalho: 75-120psi
Ruído: 85-90dba
Fêmea: 1/4"



JAZ-000

Enrolador ar

Ref.	Mangueira ø (mm)	Mangueira compr.(m)	Preço
JAZ-0001B	8x12	15	128.00€
JAZ-0002A	8x12	9	96.00€
JAZ-0002B	9,5x13,3	7,5	96.00€
JAZ-0002C	6,5x10	10	94.00€



JAZ-39520

175.00€

Enrolador móvel para ar de 3/8"

Comprimento: 20m
Pressão máxima: 15bar
Peso: 7 000g
Interior mangueira: 9,5mmø
Ligação: 3/8"



JA-725

Mini lubrificador óleo para máquinas pneumáticas

Ref.	Medida	Preço
JA-7253	1/4"	6.70€
JA-7254	3/8"	9.90€



JAZ-0042

13.50€

Cardan para máquinas pneumáticas 1/4"



JAZ-0513

Copo plástico para filtros lubrificadores JAZ-0512/ JAZ-0513

Ref.	Especif.	Preço
JAZ-0513-09	ar	4.40€
JAZ-0513-50	óleo	4.50€



JAZ-0514

Copo plástico para filtros lubrificadores JAZ-0514/ JAZ-0515

Ref.	Especif.	Preço
JAZ-0514-09	ar	6.20€
JAZ-0514-48	óleo	6.20€



JAZ-051

Filtro lubrificador com regulador de pressão



Ref.	Entrada	Fluxo (l/min)	Pressão (bar)	Filtro (µm)	Preço
JAZ-0512	1/4"	1 000	0,5-8,5	5	70.00€
JAZ-0513	3/8"	1 350	0,5-8,5	5	69.50€
JAZ-0514	1/2"	3 000	0,5-8,5	5	102.50€
JAZ-0516	3/4"	3 100	0,5-8,5	5	108.00€

Nota: A pressão máxima de alimentação é de 8.5bar

JAZ-6704A

Filtro lubrificador com regulador de pressão



Entrada	Fluxo (l/min)	Pressão (bar)	Filtro (µm)	Preço
1/2"	1 250	1-10	5	100.00€

JAZ-6710A

Filtro de ar 1/2"



39.00€

JAZ-6711A

Regulador de pressão 1/2"



48.50€

JAZ-6712A

Lubrificador de ar 1/2"



38.00€

JAZ-6715A

Filtro de ar com regulador 1/2"



66.00€

JAZ-6704

Copo plástico para filtros lubrificadores JAZ-6704A/ JAZ-6710A

Ref.	Especif.	Preço
JAZ-6704-W	ar	9.30€
JAZ-6704-O	óleo	4.90€

JAZ-7214

Tubo espiral fêmea de 1/4"



Ref.	Medida (mm)	Compr. (m)	Preço
JAZ-7214F	5x8	13	20.00€
JAZ-7214S	6,5x10	13	29.00€
JAZ-7214Z	8x12	15	43.00€

GM-0

Tomada rápida fêmea



Ref.	Medida	Preço
GM-02AF	1/4"	5.70€
GM-03AF	3/8"	6.00€
GM-04AF	1/2"	6.50€

GM-0

Tomada rápida macho



Ref.	Medida	Preço
GM-02AM	1/4"	6.00€
GM-03AM	3/8"	6.10€
GM-04AM	1/2"	6.20€

GM-0

Tomada rápida tubo



Ref.	Medida	Preço
GM-02AH	1/4"	6.40€
GM-03AH	3/8"	6.80€
GM-04AH	1/2"	6.85€
GM-02BH	5/16"	6.80€

Acessórios para redes de ar comprimido

GM-0

Ponteira fêmea

Ref.	Medida	Preço
GM-02PF	1/4"	1.10€
GM-03PF	3/8"	2.10€
GM-04PF	1/2"	2.35€



GM-0

Ponteira macho

Ref.	Medida	Preço
GM-02PM	1/4"	1.10€
GM-03PM	3/8"	2.00€
GM-04PM	1/2"	2.35€



GM-0

Ponteira tubo

Ref.	Medida	Preço
GM-02PH	1/4"	1.25€
GM-03PH	3/8"	1.20€
GM-04PH	1/2"	1.55€
GM-02BPH	5/16"	1.20€



KIT AR

52.00€

Jogo de acessórios de ligação a rede de ar

Composição:

GM-02AF	Tomada rápida fêmea de 1/4"
GM-02PF	Ponteira fêmea de 1/4"
GM-02PM	Ponteira macho de 1/4"
JAT-6905B	Pistolete simples para ar
JAZ-7214S	Tubo espiral 13m





JONNESWAY®

Merchandising



Merchandising

BOUTJW01A-M	9.50€
BOUTJW01A-L	9.50€
BOUTJW01A-XL	9.50€

T-shirt

Com o logotipo da Jonnesway estampado no peito e na manga, nos tamanhos M, L e XL.



BOUTJW02A	6.50€
-----------	-------

Boné

Com o logotipo da Jonnesway bordado.



JW-01B	11.00€
--------	--------

Boné

Com o logotipo da Jonnesway bordado.



BOUTJW03B	29.50€
-----------	--------

Esferográfica 50 unidades

Com o logotipo da Jonnesway.



BOUTJW04A-M	27.00€
-------------	--------

BOUTJW04A-L	27.00€
-------------	--------

BOUTJW04A-XL	27.00€
--------------	--------

Polar bege

Com o logotipo da Jonnesway bordado no peito, nos tamanhos M, L e XL.



BOUTJW05A	17.50€
-----------	--------

Guarda-chuva 1 unidade

Com o logotipo da Jonnesway estampado.



BOUTJW06B	22.00€
-----------	--------

Lona Jonnesway

Medidas: 1 480x890mm



BOUTJW07A-M	14.00€
-------------	--------

BOUTJW07A-L	14.00€
-------------	--------

BOUTJW07A-XL	14.00€
--------------	--------

Polo

Com o logotipo da Jonnesway bordado no peito, nos tamanhos M, L e XL.



BOUTJW07B-M	19.50€
-------------	--------

BOUTJW07B-L	19.50€
-------------	--------

BOUTJW07B-XL	19.50€
--------------	--------

Polo

Com o logotipo da Jonnesway bordado no peito, nos tamanhos M, L e XL.



BOUTJW08B-50 50.00€

BOUTJW08B-52 50.00€

BOUTJW08B-54 50.00€

Fato-macaco cinza

Com o logotipo da Jonnesway estampado no peito e nas costas.



BOUTJW09A 8.00€

Dispositivo de armazenamento de dados - pen USB 1 unidade

Capacidade: 4 Gb



JW-USB 13.00€

Dispositivo de armazenamento de dados - pen USB 1 unidade

Capacidade: 16 Gb



BOUTJW13A 5.50€

Para-sol

Com o logotipo da Jonnesway.



Merchandising

BOUTJW14B 18.50€

Mochila

Com o logotipo da Jonnesway bordado.

Dimensões: 280x380x120mm



JW-BACKPACK 79.00€

Mochila



BOUTJW15A 25.00€

Esferográfica "touch" 20 unidades

Com o logotipo da Jonnesway.



BOUTJW16A 2.60€

Porta chaves 1 unidade



BOUTJW17A-1 3.30€

Autocolante Jonnesway

Medidas: 70x400mm



BOUTJW17A-2 8.30€

Autocolante Jonnesway

Medidas: 100x600mm



BOUTJW18A 4.00€

Esferográfica

Com o logotipo da Jonnesway.



BOUTJW19A 30.50€

Esferográfica "roller ball"
Com o logotipo da Jonnesway.



BOUTJW20A-M 21.50€

BOUTJW20A-L 21.50€

BOUTJW20A-XL 21.50€

Sweat shirt

Com o logotipo da Jonnesway bordado no peito,
nos tamanhos M, L e XL.



BOUTJW21A-M 56.00€

BOUTJW21A-L 56.00€

BOUTJW21A-XL 56.00€

Colete

Com o logotipo da Jonnesway bordado no peito,
nos tamanhos M, L e XL.



BOUTJW22A-M 49.50€

BOUTJW22A-L 49.50€

BOUTJW22A-XL 49.50€

Casaco

Com o logotipo da Jonnesway bordado no peito,
nos tamanhos M, L e XL.



BOUTJW23A-M 39.00€

BOUTJW23A-L 39.00€

BOUTJW23A-XL 39.00€

Calças

Com o logotipo da Jonnesway bordado,
nos tamanhos M, L e XL.



BOUTJW24A 5.90€

Bloco de notas A5

Com o logotipo da Jonnesway.

Medidas: 140x210mm



BOUTJW25B 31.00€

Pasta A4

Com o logotipo da Jonnesway estampado.

Medidas: 245x325x40mm



BOUTJW26A 56.00€

Mala para portátil

Com o logotipo da Jonnesway estampado.

Medidas: 410x300x80mm



BOUTJW27A

21.00€

Rato sem fios
Com o logotipo da Jonnesway.



BOUTJW28A

17.50€

Base carregadora por indução para telemóveis

Dimensões: 69x10mm

Caraterísticas:

Carregador por indução com potência de carga até 10w.

Inclui cabo USB/ micro USB.

Compatível com smartphones com tecnologia de carregamento sem fios.



BOUTJW29A

140.00€

Bandeira barbatana tubarão

Dimensões: 660x2000mm



C-DS4

399.00€

Expositor para ferramenta com painéis perfurados e 30 ganchos

Medidas:

Altura: 2 140mm

Profundidade: 660mm

Largura: 940mm



C-DSP

399.00€

Expositor para ferramenta com painéis perfurados e 30 ganchos

Medidas:

Altura: 2 140mm

Profundidade: 660mm

Largura: 940mm



C-DS4-H

0.99€

Gancho para expositor C-DS4

DS96

95.00€

Expositor vazio para chaves de fenda

Capacidade: 96 chaves

Dimensões: 595x240x210mm



C-DS14

140.00€

Expositor para chaves caixa

Dimensões: 350x420x350mm



JAZ-ST4

35.00€

Base em acrílico para máquinas pneumáticas



FITA JW

3.00€

Fita Jonnesway para embalagem



JW-OPENER

3.10€

Tira cápsulas





JONNESWAY®

de Professionais para Profissionais



SGS Reference No: RA/2015/30009C
Page 1 of 1

VERIFICATION OF COMPLIANCE

to the requirements of
Machinery Directive 2006/42/EC

Verification Report No. : RA/2015/30009C
Representative Model : JAI-1108, JAI-1056
Series Model(s) : JAI-1108, JAI-1108L, JAI-1126, JAI-1128, JAI-0963, JAI-0964, JAI-0966, JAI-0923, JAI-0924, JAI-0926, JAI-0936, JAI-1044, JAI-1054, JAI-6280, JAI-0501, JAI-0405, JAI-6283, JAI-0803
Product Name : Air Impact Wrench
Applicant : JONNESWAY ENTERPRISE CO., LTD.
Address of Applicant : 6F-9, No. 51, Sec. 2, Keelung Rd., Taipei, Taiwan
TCF Number : JONNESWAY-20150301-V1
Date of Issue : June 19, 2015
Date of Expiry : June 18, 2020
Applicable Standard(s) : EN ISO 12100 :2010, EN ISO 11148-6 :2012

Conclusion
Based upon a review of the Technical Construction File, the apparatus is deemed to meet the requirements of the above standard(s) and hence fulfill the requirements of:

Machinery Directive 2006/42/EC

*Note : This verification is only valid for the apparatus and configuration described and in conjunction with the technical data detailed above.
The CE mark as shown below can be used, under the responsibility of the manufacturer, after completion an EC Declaration of Conformity and compliances with all relevant EC Directives.*

Authorized Signatory:



SGS TAIWAN LTD.
Jason Lin
Technical Manager

This document is issued by the Company subject to its General Conditions of Service printed overleaf, available on request or accessible at <http://www.sgs.com/en/Terms-and-Conditions.aspx> and, for electronic format documents, subject to Terms and Conditions for Electronic Documents at <http://www.sgs.com/en/Terms-and-Conditions/Terms-and-Conditions.aspx>. Attention is drawn to the limitation of liability, indemnification and arbitration issues detailed therein. Any holder of this document is advised that information contained herein reflects the Company's findings at the time of its intervention only and within the limits of Client's instructions. If any, the Company's sole responsibility is to its Client and the document does not exonerate parties to a transaction from exercising all their rights and obligations under the transaction documents. This document cannot be reproduced except in full, without prior written approval of the Company. Any unauthorized alteration, forgery or falsification of the content or appearance of this document is unlawful and offenders may be prosecuted to the fullest extent of the law. Unless otherwise stated the results shown in this test report refer only to the sample(s) tested.

SGS Taiwan Ltd. | 134, Wu Kang Road, Wu Ku District, New Taipei City, Taiwan / 新北市五股區五工路134號
台灣檢驗科技股份有限公司 | (886-2) 2298-3939 | (886-2) 2298-2000 | www.sgs.tw
Member of SGS Group

TWB 4262448



SGS Reference No: RA/2019/60012C
Page 1 of 1

VERIFICATION OF COMPLIANCE

to the requirements of
Machinery Directive 2006/42/EC

Verification Report No. : RA/2019/60012C
Representative Model : JAI-1138L
Series Model(s) : JAI-1138, JAI-1408, JAI-1408L, JAI-1418, JAI-1418L, JAI-1208, JAI-1208L, JAI-1206, JAI-1206L, JAI-1218, JAI-1218L, JAI-1114, JAI-1124, JAI-1024, JAI-1014, JAI-1313, JAI-1314, JAI-6259, JAI-6259-8, JAI-6225, JAI-6225-8, JAI-6276, JAI-6276L, JAI-6277, JAI-6277L, JAI-6211, JAI-6211L, JAI-6212, JAI-6212L, JAI-1513, JAI-1514, JAI-0954, JAI-1524
Product Name : AIR IMPACT WRENCH
Applicant : JONNESWAY ENTERPRISE CO., LTD
Address of Applicant : 6F-9, NO.51, SEC. 2, KEELUNG RD., TAIPEI TAIWAN
TCF Number : JONNESWAY-201906-J1
Date of Issue : June 25, 2019
Date of Expiry : June 25, 2024
Applicable Standard(s) : EN ISO 12100 :2010, EN ISO 11148-6:2012

Conclusion
Based upon a review of the Technical Construction File, the apparatus is deemed to meet the requirements of the above standard(s) and hence fulfill the requirements of:

Machinery Directive 2006/42/EC

*Note : This verification is only valid for the apparatus and configuration described and in conjunction with the technical data detailed above.
The CE mark as shown below can be used, under the responsibility of the manufacturer, after completion an EC Declaration of Conformity and compliances with all relevant EC Directives.*

Authorized Signatory:



SGS TAIWAN LTD.
Jason Lin
Technical Manager

This document is issued by the Company subject to its General Conditions of Service printed overleaf, available on request or accessible at <http://www.sgs.com/en/Terms-and-Conditions.aspx> and, for electronic format documents, subject to Terms and Conditions for Electronic Documents at <http://www.sgs.com/en/Terms-and-Conditions/Terms-and-Conditions.aspx>. Attention is drawn to the limitation of liability, indemnification and arbitration issues detailed therein. Any holder of this document is advised that information contained herein reflects the Company's findings at the time of its intervention only and within the limits of Client's instructions. If any, the Company's sole responsibility is to its Client and this document does not exonerate parties to a transaction from exercising all their rights and obligations under the transaction documents. This document cannot be reproduced except in full, without prior written approval of the Company. Any unauthorized alteration, forgery or falsification of the content or appearance of this document is unlawful and offenders may be prosecuted to the fullest extent of the law. Unless otherwise stated the results shown in this test report refer only to the sample(s) tested.

SGS Taiwan Ltd. | 134, Wu Kang Road, Wu Ku District, New Taipei City, Taiwan / 新北市五股區五工路134號
台灣檢驗科技股份有限公司 | (886-2) 2298-3939 | (886-2) 2298-2000 | www.sgs.tw
Member of SGS Group

TWB 4262448



JONNESWAY[®]

Outros Equipamentos



Outros equipamentos

AE020009

340.00€

Bomba hidropneumática

Pressão de serviço: 690bar
 Alimentação: 7-10bar
 Dimensões: 257,50x127x204,50mm
 Peso: 8 000g
 Capacidade: 1 660cc



AE060002

570.00€

Macaco para transmissões

Altura máxima: 750mm
 Altura mínima: 200mm
 Capacidade: 1t
 Dimensões: 865x480mm
 Peso: 60kg



AE060003

1 050.00€

Macaco para transmissões

Altura máxima: 890mm
 Altura mínima: 165mm
 Capacidade: 1,5t
 Dimensões: 1 105x652mm
 Peso: 130kg



AE070002A

435.00€

Macaco de fossa

Altura máxima: 1 835mm
 Altura mínima: 1 035mm
 Capacidade: 600kg

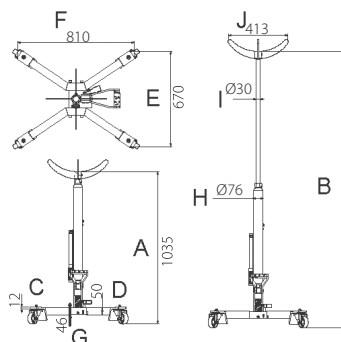

AE080001

600.00€

Macaco de fossa com prato universal

Altura máxima: 1 377mm
 Altura mínima: 880mm
 Capacidade: 500kg
 Prato: 729x597mm

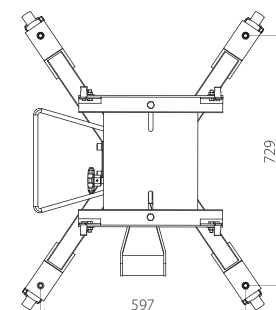
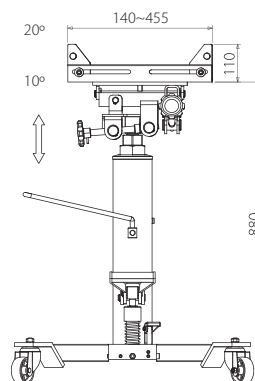
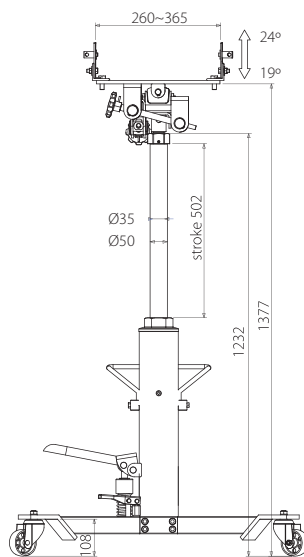

AE090025

460.00€

Macaco de rodas baixo perfil em alumínio

Altura máxima: 445mm
 Altura mínima: 87mm
 Capacidade: 2 000kg



AG010154

12.50€

Banco plástico de apoio com rodas

Dimensões: 450x335x310mm
 Peso: 1 500g



AG010219

99.00€

Banco metálico com rodas

Dimensões: 350x260x240mm
 Capacidade: 150kg

Inclui: Gaveta
 Suporte lateral para peças
 Prateleira de apoio



AG010222

73.00€

Banco metálico com rodas

Dimensões: 330x350x560mm
 Capacidade: 130kg

Inclui: Gaveta
 Suportes laterais para peças



AE090105A

49.00€

Estrado para mecânico

Dimensões: 1 000x470x130mm
 Carga admissível: 120kg



AE110020

915.00€

Macaco hidropneumático

Altura máxima: 377mm
 Altura mínima: 205mm
 Capacidade: 20t

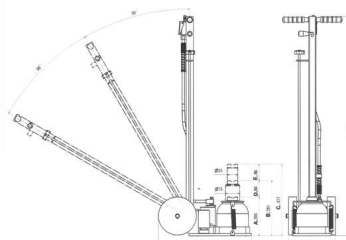

AE130003

790.00€

Grua hidráulica de 2t

Caraterísticas em mm:
 Altura mínima: 60
 Elevação máxima: 2 330
 Largura da base: 718-936
 Comprimento da base: 1 606-2 426
 Comprimento máximo braço: 1 960



AE130003-1

84.00€

Travessa

Capacidade: 500kg



AE140013

655.00€

Suporte articulado de motores

Capacidade: 600kg

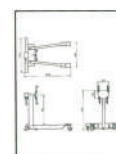

AE150001

180.00€

Preguiça

Altura: 710-1 065mm
Capacidade: 12t



AE150002

150.00€

Preguiça para pesados

Altura: 456-710mm
Capacidade: 12t



AE170002

123.00€

Travessa para suporte de motores

Ajuste: 530-1 480mm



AE010025A

285.00€

Jogo prensa de chapeiro de 4t

Composição:
Bomba hidráulica manual
Cilindro hidráulico: 4t (369-522mm)
Pinça de alargamento
Adaptadores
Extensões
Mala com rodas



AE010015A

460.00€

Jogo prensa de chapeiro de 10t

Composição:
Bomba hidráulica manual
Cilindro hidráulico: 10t (369-522mm)
Pinça de alargamento
Adaptadores
Extensões
Mala com rodas



AE050003

143.00€

Macaco chapeiro 5t

Capacidade: 5t
Comprimento: 750mm
Curso pistão: 160mm



AE180001

175.00€

Travessa para portas

Comprimento: 74-115mm



AE200003

1 025.00€

Elevador para rodas veículos pesados

Capacidade: 600kg
Elevação: 395 mm



AE300149

132.00€

Aparadeira de óleo

Aparadeira regulável em altura em polietileno de alta densidade com descarga por gravidade.

Capacidade: 50l
 Peso: 12kg
 Dimensões: 550x550x990~1 070 mm



AR020016

81.00€

Multímetro digital e analisador automóvel

Funções: RPM, dwell, volts AC/DC, amps DC, resistências, ciclo de trabalho, temperatura, testes díodos e teste continuidade.



AR020060

199.00€

Pinça amperimétrica

De acordo com a norma IEC 1010 CAT III 1 000V

Multímetro digital com escalas automáticas
 Multifunções para AC/DV amp; AC/DC V e Ohms
 Capacitância, frequência e díodos
 Proteção de sobrecarga
 Memória
 RMS (valor eficaz)
 Pinça amperimétrica: 2 000A - AC/DC
 Gama medição: 2 000 A AC/400A DC



AR020061

150.00€

Multímetro digital

De acordo com a norma IEC 1010 CAT III 1 000V

Mostrador de grande dimensão
 Escalas automáticas AC/DC para voltagem, amperagem, capacitância, frequência e resistência
 Leitura até 10 Amp com proteção e impedância alta para leituras de mV
 Memória
 RMS (valor eficaz)



AR030067

34.00€

Medidor de voltagem multifuncional

Pilhas não incluídas

Leitura de corrente AC/DC: 12-690V
 Mostrador LED/LCD



C-T4A

455.00€

Bancada de trabalho cinzenta com 3 gavetas

Tampo metálico com cobertura em acrílico

Medidas:
 Altura: 800mm
 Profundidade: 700mm
 Largura: 1 525mm



C-T5G-DP

93.00€

Painel traseiro cinzento para bancada

Aplicação:
 Bancada: C-T4A

Medidas:
 Altura: 700mm
 Largura: 1 525mm

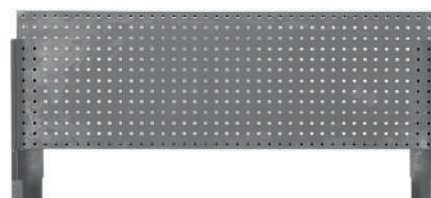

C-DBU1

1.25€

Gancho para painel traseiro de bancada

Aplicação:
 Painel: C-T5G-DP
 Armários: C-SA
 Comprimento: 25,4mm

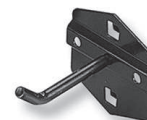

C-DBU7

1.60€

Gancho para painel perfurado

Aplicação:
 Painel: C-T5G-DP
 Armários: C-SA
 Comprimento: 50,8mm



AB0	Pag.					AG0	Pag.
AB010001	150	AB030076-27	156	AE300206	122	AG010002	86
AB010002	150	AB030076-28	156	AE300207	122	AG010002S	86
AB010002-A	150	AB030076-30	156	AE300211	122	AG010002SP	28
AB010017	150	AB030076-32	156	AE300212	119	AG010003	86
AB010018	150	AB030076-34	156	AE300215	122	AG010005	86
AB010019	150	AB030089	152	AE300220	123	AG010006	86
AB010020	150	AB030094J	152	AE310002	119	AG010008	87
AB010026S	150	AB030100	152	AE310003	153	AG010009	87
AB010041	151	AC	Pag.	AE310006	119	AG010011	87
AB010043	151	ACC-609	170	AE310008	119	AG010012	87
AB020002	151	AEO	Pag.	AE310010A	119	AG010023	153
AB020003	151	AE010015A	188	AE310013	119	AG010024	153
AB020009	151	AE010025A	188	AE310014	119	AG010024-1	153
AB020010	151	AE020009	186	AE310016	119	AG010024-2	153
AB020015	151	AE040020	118	AE310023	120	AG010026SP	28
AB020019	151	AE050003	188	AE310024	119	AG010030A	153
AB030001	151	AE060002	186	AE310025	119	AG010034	123
AB030014	151	AE060003	186	AE310026	119	AG010035	123
AB030028	151	AE070002A	186	AE310027	119	AG010036	123
AB030041	151	AE080001	186	AE310034	120	AG010046	123
AB030043	151	AE090025	187	AE310035	120	AG010049	123
AB030046	151	AE090105A	187	AE310037	120	AG010055	153
AB030047	151	AE110020	187	AE310038	120	AG010055-B	153
AB030048	151	AE130003	187	AE310062	120	AG010059	123
AB030056	118	AE130003-1	187	AE310063	120	AG010059-10	123
AB030060	152	AE140013	187	AE310066	120	AG010059-12	123
AB030061	118	AE150001	188	AE310073	120	AG010059-6	123
AB030068A	152	AE150002	188	AE310077	120	AG010059-8	123
AB030068C	152	AE150005	118	AE310087	120	AG010089	123
AB030068D	152	AE170002	188	AE310099	120	AG010099	124
AB030068F	152	AE180001	188	AE310109A	121	AG010109	124
AB030069A	152	AE200003	188	AE310110	121	AG010111	123
AB030069B	152	AE300064	118	AE310112	121	AG010118A	124
AB030069E	152	AE300064-02	118	AE310122	120	AG010138	154
AB030070B	152	AE300064-03	118	AE310146B	121	AG010138-B	154
AB030070C	152	AE300064-04	118	AE310146D	121	AG010140	154
AB030070D	152	AE300064-05	118	AE310146E	121	AG010141	154
AB030071	152	AE300064-06	118	AE310146G	121	AG010142	154
AB030076-00	156	AE300064-07	118	AE310146H	121	AG010143	154
AB030076-01	156	AE300064-15	118	AE310150	120	AG010147	124
AB030076-02	156	AE300064-16	118	AE310172	121	AG010150SC	28
AB030076-03	156	AE300100-040	118	AE310180	121	AG010154	187
AB030076-05	156	AE300100-042	118	AE310183	121	AG010159	123
AB030076-06	156	AE300100-060	118	AE320023	121	AG010163A	123
AB030076-07	156	AE300100-060	118	AE320034	121	AG010164	123
AB030076-11	156	AE300149	189	AE320035	121	AG010167	155
AB030076-13	156	AE300152	118	AE320044	121	AG010168	155
AB030076-14	156	AE300154B	122	AE330004	153	AG010169	155
AB030076-15	156	AE300168	122	AE330005	153	AG010184F	76
AB030076-17	156	AE300168-1	122	AE330008	153	AG010185	153
AB030076-18	156	AE300173	119	AE330009	153	AG010204	143
AB030076-20	156	AE300176-A	119	AE330013	153	AG010205	139
AB030076-21	156	AE300180	135	AE330015	153	AG010207	111
AB030076-24	156	AE300201	122	AE330016	153	AG010208	124
AB030076-26	156	AE300202	122	AE330030	153	AG010219	187
		AE300204	122	AE330034	153		
		AE300205	122	AE330035	154		

AG010222	187	AI020024	127	AI040011	131	AI060031-E	135
AG010224	111	AI020025	127	AI040017	131	AI060031-G	135
AG010225	124	AI020027	127	AI040018	131	AI060031-H	135
AG010227	124	AI020043	128	AI040031	130	AI060031-J	135
AG010229	124	AI020048A	127	AI040060	131	AI1	Pag.
AG10001SP	28	AI020048D	127	AI040246	131	AI10001SP	28
AG10001SP-G	124	AI020048E	127	AI050001	133	AI10002SP	28
AG10001SP-T	124	AI020049	128	AI050004	132	AI10003SP	29
AG10001SP-W	125	AI020051	128	AI050004A	132	AL0	Pag.
AG10002SC	39	AI020052	128	AI050009A	133	AL010006	135
AG10002SC-W	125	AI020054	128	AI050022	133	AL010011	135
AH0	Pag.	AI020056A	128	AI050024	133	AL010029	146
AH020002	125	AI020066	128	AI050037	133	AL010038	145
AIO	Pag.	AI020092	128	AI050040	133	AL010041	145
AI010006	125	AI020101A	128	AI050042	133	AL010044	142
AI010009	125	AI020101A-A	128	AI050043	133	AL010053A	146
AI010023	125	AI020103	128	AI050043S	130	AL010057	144
AI010029	125	AI020107	129	AI050071S	142	AL010070	142
AI010030	125	AI020109	129	AI050071S	144	AL010071	142
AI010033	134	AI020113	144	AI050076	133	AL010072	147
AI010037	125	AI020127	146	AI050077	133	AL010087	147
AI010041	126	AI020131	129	AI050079	146	AL010088	147
AI010060	126	AI020142	129	AI050080	133	AL010093	135
AI010060-A	126	AI020154	146	AI050085A	144	AL010099	141
AI010060-B	126	AI020158	156	AI050092	134	AL010113	155
AI010060-C	126	AI020162	129	AI050093	134	AL010114	155
AI010060-D	126	AI020163	129	AI050096S	134	AL010116	155
AI010063A	126	AI020164	155	AI050102	134	AL010117	155
AI010069	146	AI020178	129	AI050104	134	AL010128	141
AI010070	146	AI020180	129	AI050109	134	AL010175	142
AI010086	126	AI020184	144	AI050110	156	AL010175	144
AI010092	127	AI020184	129	AI050113	134	AL010190	145
AI010097	143	AI020184A	142	AI050135	155	AL010196	142
AI010104	127	AI020184A	146	AI050152	134	AL010202	147
AI010107	142	AI020184A	129	AI050152A	134	AL010203	147
AI010108	147	AI020184B	144	AI050172	155	AL010205	143
AI010110	147	AI020184B	129	AI050176	134	AL010218	143
AI010114	143	AI020184B	129	AI050191	135	AL010225	147
AI010115	141	AI020184S	129	AI050192	135	AL010282	143
AI010116	143	AI020185	130	AI050200	144	ANO	Pag.
AI010121	141	AI020186	144	AI050201	146	AN010001	135
AI010127	127	AI020201	130	AI050201	146	AN010001C	135
AI010136	144	AI020205	130	AI050202	134	AN010001D	135
AI010137	127	AI030002	131	AI060006	135	AN010001D-2	135
AI010139	141	AI030007	130	AI060020	135	AN010001D-3	135
AI010153	155	AI030010	130	AI060030	135	AN010001D-4	135
AI010166	127	AI030011	130	AI060030-A	135	AN010001D-5	135
AI010167	127	AI030020	130	AI060030-B	135	AN010001D-6	135
AI010176	127	AI030025	130	AI060030-C	135	AN010001D-7	135
AI010195	127	AI030027	130	AI060030-D	135	AN010001D-A	135
AI010201	131	AI030045	109	AI060030-E	135	AN010001D-E	135
AI020015	127	AI030067	133	AI060030-F	135	AN010001D-F	135
AI020019	127	AI030075	138	AI060031	135	AN010001D-K	135
AI020020	127	AI040005	131	AI060031-A	135	AN010001D-M	135
AI020021	127	AI040006	131	AI060031-B	135	AN010001D-N	135
		AI040007	130	AI060031-C	135		
		AI040008	130	AI060031-D	135		

AN010009A	133	AN040200	155	BOUTJW07A-M	180	C-7	Pag.
AN010030	133	AN040286	143	BOUTJW07A-XL	180	C-7 TOWER	22
AN010033	137	AN100002SP	29	BOUTJW07B-L	180	C-7DB2	21
AN010038	137	ARO	Pag.	BOUTJW07B-M	180	C-7DC2B	21
AN010045	120	AR020016	189	BOUTJW07B-XL	180	C-7DS1	21
AN010049	137	AR020018	140	BOUTJW08B-50	181	C-7DW1-TS	24
AN010054A	137	AR020019	140	BOUTJW08B-52	181	C-7DW9	21
AN010054N	137	AR020053A	140	BOUTJW08B-54	181	C-A	Pag.
AN010063	137	AR020060	189	BOUTJW09A	181	C-A10	25
AN010065	137	AR020061	189	BOUTJW13A	181	C-A11	25
AN010066	137	AR030013	140	BOUTJW14B	181	C-A12	25
AN010068	137	AR030022	156	BOUTJW15A	181	C-A13	25
AN010072	138	AR030024	156	BOUTJW16A	181	C-A16W	22
AN010072C	138	AR030034	140	BOUTJW17A-1	181	C-A17W	22
AN010081A	137	AR030041	140	BOUTJW17A-2	181	C-A2501S	25
AN010085A	137	AR030047	140	BOUTJW18A	181	C-A27	24
AN010091A	138	AR030058	91	BOUTJW19A	182	C-A3	24
AN010092	138	AR030062	140	BOUTJW20A-L	182	C-A3-B	24
AN010106A	138	AR030067	189	BOUTJW20A-M	182	C-A31	24
AN010112	138	AR040016	140	BOUTJW20A-XL	182	C-A3G	24
AN010131	138	AR040043	140	BOUTJW21A-L	182	C-A456	24
AN010137	138	AR060002A	140	BOUTJW21A-M	182	C-A7*	25
AN010160	137	AR060003	140	BOUTJW21A-XL	182	C-A8*	25
AN010177B	141	AR060008	140	BOUTJW22A-L	182	C-A9	24
AN010186B	138	AR060011	140	BOUTJW22A-M	182	C-APB	25
AN010187	155	AR060020	140	BOUTJW22A-XL	182	C-B	Pag.
AN010188A	138	AR060021	141	BOUTJW23A-L	182	C-B5	25
AN010188C	138	AR060024A	141	BOUTJW23A-M	182	C-BS Kit1	24
AN010202	147	AR060029	141	BOUTJW23A-XL	182	C-BS Kit2	24
AN010202B	147	AR060032	141	BOUTJW24A	182	C-BS Kit3	24
AN010225	138	AR060043	141	BOUTJW25B	182	C-D	Pag.
AN010226	138	AR060055	141	BOUTJW26A	182	C-DBU1	189
AN010235	155	AR060062	137	BOUTJW27A	183	C-DBU7	189
AN010237	155	AS	Pag.	BOUTJW28A	183	C-DM1	111
AN010272	139	AS-0013	170	BOUTJW29A	183	C-DMH212	74
AN010279	139	AS-0013A2	170	C-1	Pag.	C-DMH314	74
AN010293	137	AS-0015	170	C-10DW42	22	C-DMH414	74
AN020007	139	AS-0026	170	C-13DW53	22	C-DS14	183
AN020007-1	139	AS-0065	123	C-1DM1	20	C-DS4	183
AN020022	139	AZ	Pag.	C-3	Pag.	C-DS4-H	183
AN020022-A	139	AZ-0513-09	176	C-3DH2	23	C-DSP	183
AN020022-B	139	BLA	Pag.	C-3DH262	23	C-P	Pag.
AN020022-C	139	BLACK POWER 19	9	C-3DH5	23	C-PC1	24
AN020022-D	139	BOU	Pag.	C-3DW5	20	C-PC2	24
AN040035A	139	BOUTJW01A-L	180	C-4	Pag.	C-PC3	24
AN040043A	139	BOUTJW01A-M	180	C-4DWA1	21	C-PC4	24
AN040055	156	BOUTJW01A-XL	180	C-4DWA1G	21	C-S	Pag.
AN040056	156	BOUTJW02A	180	C-5	Pag.	C-S7DW1	19
AN040062	155	BOUTJW03B	180	C-5CD	23	C-SA2	18
AN040066	155	BOUTJW04A-L	180	C-6	Pag.	C-SA2S	18
AN040082	139	BOUTJW04A-M	180	C-6DA4	23	C-SA3	18
AN040100	145	BOUTJW04A-XL	180	C-6DA494	23	C-SA3S	18
AN040101	139	BOUTJW05A	180	C-6DWB1	21	C-SA4S	19
AN040105	155	BOUTJW06B	180	C-6DWB1G	21	C-SG	20
AN040126	144	BOUTJW07A-L	180	C-6DWB5	21	C-SInox	20
AN040168	139						

C-SM	20	D12	Pag.	D150H030A	101	D70	Pag.
C-SP3401	19	D125F4506A	100	D150H040B	101	D70105KV	36
C-SQ2401	19	D125F6512A	100	D150H050A	101	D70105SP	29
C-SQ3401	19	D125F8016A	100	D150H060B	101	D70P175	94
C-SQ3402	19	D125H015A	100	D150H070B	101	D70P2100	94
C-SQ3403	19	D125H020A	100	D150H080B	101	D70P3125	94
C-SU01	20	D125H025A	100	D150MH1AD	101	D70P3150	94
C-SU02	20	D125H030A	100	D150MH1QD	101	D70PP07S	94
C-SW01	20	D125H040A	100	D150P1A	100	D70PP10S	94
C-SW02	20	D125H050A	100	D150P2A	100	D70PS119KV	36
C-T	Pag.	D125H060A	100	D150P3A	100	D70S475	94
C-T12	23	D125H070A	100	D150T20A	101	D70S5100	94
C-T3	22	D125P1F	100	D150T25A	101	D70S6125	94
C-T4A	189	D125P2F	100	D150T27A	101	D70S6150	94
C-T5G-DP	189	D125P3F	100	D150T30A	101	D70S8150	94
C-W	Pag.	D125T06B	100	D150T40A	101	D70S8175	94
C-WHEEL1	25	D125T08B	100	D150Z1A	100	D70S9175	94
C-WHEEL2	25	D125T10A	100	D150Z2A	100	D70S9250	94
C-WHEEL5	25	D125T15A	100	D150Z3A	100	D71	Pag.
C-WHEEL6	25	D125T20A	100	D16	Pag.	D71157SV	34
C-WHEEL8	25	D125T25A	100	D165MN06M	102	D71400T10	96
C-WHEEL9	25	D125T27A	100	D165MN07M	102	D71400T15	96
CF	Pag.	D125T30A	100	D165MN08M	102	D71400T20	96
CF-K-C	173	D125T40A	100	D165MN10M	102	D71400T25	96
CF-K-E	173	D125TT08B	101	D165MN12M	102	D71400T27	96
CF-K-F	173	D125TT10B	101	D165MN13M	102	D71400T30	96
CF-K-G	173	D125TT15B	101	D17	Pag.	D715N05	97
CF-K-I	173	D125TT20B	101	D175H100	101	D715N07	97
CF-K-J	173	D125TT25B	101	D175H120	101	D715N08	97
CH	Pag.	D125TT27B	101	D175H40	101	D715N10	97
CHAPEIRO20- BLACK	14	D125TT30B	101	D175H50	101	D715N12	97
CHAPEIRO20-C	14	D125TT35B	101	D175H60	101	D715N13	97
CHAPEIRO20-GREEN	14	D125TT40B	101	D175H70	101	D71C105S	97
CHAPEIRO20-V	14	D125Z1A	100	D175H80	101	D71C106S	97
CHAPEIROALU-BLACK	15	D125Z2A	100	D175T20	101	D71P060	95
CHAPEIROALU-C	15	D125Z3A	100	D175T25	101	D71P1100	95
CHAPEIROALU-GREEN	15	D13	Pag.	D175T30	101	D71P1150	95
CHAPEIROALU-V	15	D130H100	100	D175T40	101	D71P1300	95
D10	Pag.	D130H120	100	D175T45	101	D71P138	95
D100MN08M	101	D130H40	100	D175T50	101	D71P180	95
D100MN10M	101	D130H50	100	D175T55	101	D71P2100	95
D100MN12M	101	D130H60	100	D37	Pag.	D71P2150	95
D100MN13M	101	D130H70	100	D3750P08S	98	D71P2250	95
D100MN14M	101	D130H80	100	D3750T08S	98	D71P238	95
D10M30M05A	101	D130T20	100	D3750T10	98	D71P2400	95
D10M30M06A	101	D130T25	100	D3750T15	98	D71P3150	95
D10M30M08A	101	D130T30	100	D3750T18S	98	D71P3250	95
D10M30M10A	101	D130T40	100	D3750T20	98	D71P3400	95
D10M30M12A	101	D130T45	100	D3750T5	98	D71P4200	95
D10M30M14A	101	D130T50	100	D3750T6	98	D71PP08KV	36
D10M75M05A	101	D130T55	100	D3750T7	98	D71PP08S	97
D10M75M06A	101	D15	Pag.	D3750T8	98	D71PP08SP	29
D10M75M08A	101	D150F5510A	100	D3750T9	98	D71PP16S	97
D10M75M10A	101	D150F6512A	100	D376514SC	39	D71S10250	95
D10M75M12A	101	D150F8012A	100			D71S250	95
D10M75M14A	101						

D71S360	95	DB	Pag.	GM-02PH	178	H03	Pag.
D71S4100	95	DBT31B	99	GM-02PM	178	H03MH118S	103
D71S4150	95	DR	Pag.	GM-03AF	177	H03SM109S	103
D71S4200	95	DR0107S	99	GM-03AH	177	H03SS109S	103
D71S480	95	DR0253S	98	GM-03AM	177	H05	Pag.
D71S5125	95	DS	Pag.	GM-03PF	178	H05SA109S	103
D71S5200	95	DS96	183	GM-03PH	178	H05SS109S	103
D71S5300	95	DV1	Pag.	GM-03PM	178	H06	Pag.
D71S538	95	DV13P060	112	GM-04AF	177	H06MT109S	103
D71S575	95	DV13P180	112	GM-04AH	177	H06SA109S	103
D71S6100	95	DV13P2100	112	GM-04AM	177	H06SA115	103
D71S6150	95	DV13P3150	112	GM-04PF	178	H06SA120	103
D71S638	95	DV13PP07S	112	GM-04PH	178	H06SA125	103
D71S6400	95	DV13S275	112	GM-04PM	178	H06SA130	103
D71S8150	95	DV13S4100	112	GR	Pag.	H06SA140	103
D71S8200	95	DV13S5125	112	GREEN POWER 19	9	H06SA150	103
D71S8300	95	DV13S6150	112	H01	Pag.	H06SA160	103
D71S8500	95	DV13Z060	112	H01B1015	102	H06SA180	103
D71S9175	95	DV13Z180	112	H01B1020	102	H06SM209S	103
D71T10	96	DV13Z2100	112	H01B1025	102	H06SM2100	103
D71T107S	97	DV13Z3150	112	H01B1030	102	H06SM225	103
D71T109S	97	DV14PP-TP	94	H01B1035	102	H06SM230	103
D71T15	96	DV4	Pag.	H01B1040	102	H06SM240	103
D71T20	96	DV4118SV	112	H01B1045	102	H06SM250	103
D71T25	96	DV41M06S	113	H01B1050	102	H06SM255	103
D71T27	96	DV41M10	112	H01B1055	102	H06SM260	103
D71T30	96	DV41M13	112	H01B1060	102	H06SM280	103
D71T40	96	DV41M5	112	H01B1070	102	H06W106S	104
D71T45	96	DV41M6	112	H01B1080	102	H07	Pag.
D71T5	96	DV41M7	112	H01B1090	102	H07M09S	104
D71T50	96	DV41M8	112	H01B1100	102	H07MT10	104
D71T6	96	EL	Pag.	H01B1120	102	H07MT15	104
D71T7	96	ELECTR-BLACK	13	H01B1140	102	H07MT20	104
D71T8	96	ELECTR-C	13	H01B1160	102	H07MT25	104
D71T9	96	ELECTR-GREEN	13	H01B1170	102	H07MT27	104
D71Z060	96	ELECTR-V	13	H01B1180	102	H07MT30	104
D71Z105S	97	ELECTR. 1000 BLACK	11	H01B1190	102	H07MT40	104
D71Z107S	98	ELECTR. 1000 GREEN	11	H01B1220	102	H07MT45	104
D71Z138	96	ELECTR. 1000-C	11	H01MH118S	102	H07MT50	104
D71Z180	96	ELECTR. 1000-V	11	H01SA109S	102	H08	Pag.
D71Z2100	96	EV	Pag.	H01SA1100	102	H0816S	104
D71Z3150	96	EVA POWER BLACK	7	H01SA115	102	H08MTP09S	104
D71Z4200	96	EVA POWER GREEN	7	H01SA120	102	H08S110S	104
D72	Pag.	EVA POWER-C	7	H01SA125	102	H08ST09085	104
D725N06	96	EVA POWER-V	7	H01SA130	102	H08ST10090	104
D725N07	96	F	Pag.	H01SA140	102	H08ST15100	104
D725N08	96	FITA JW	183	H01SA150	102	H08ST20115	104
D725N08SP	29	GM	Pag.	H01SA160	102	H08ST25130	104
D725N09	96	GM-02AF	177	H01SA180	102	H08ST27145	104
D725N10	96	GM-02AH	177	H01SM109S	102	H08ST30165	104
D725N11	96	GM-02AM	177	H02	Pag.	H08ST40185	104
D725N12	96	GM-02BH	177	H02MH217S	102	H08ST45205	104
D725N13	96	GM-02BPH	178	H02SM109S	103	H08ST50230	104
D73	Pag.	GM-02PF	178	H02SM209S	103		
D737128SV	34						
D737134SV	34						

H10	Pag.	HC	Pag.	JA-C131SV	34	JAH-6837	174
H10121SV	34	HC-100/15	132	JA-HVLP-1080GD-N1.4	169	JAH-6837-50	174
H10MB08KV	37	HC-106/15	132	JA-HVLP-1080GK	169	JAH-6837-50-2	174
H10MB08S	104	HC-108/15	132	JA-HVLP-3000-NS17	169	JAH-6837-RK	174
H10MB08SP	29	HC-108/18	132	JA-HVLP-3000-NS19	169	JAH-7104H	174
H10MB10200	104	HC-65/14	132	JA-HVLP-300C (1.3)	169	JAH-7104H-RK	174
H10MB2100	104	HC-65/67	132	JA-HVLP-6112	170	JAI	Pag.
H10MB25100	104	HC-65103	132	JA-LVLP-0303W	170	JAI-0501-RK	161
H10MB3100	104	HC-66/6	132	JA-LVLP-0303W-N	170	JAI-0926-RK	160
H10MB4100	104	HC-68/14	132	JA-LVLP-0303W-N18	170	JAI-0936	160
H10MB5150	104	HC-73/14	132	JAB	Pag.	JAI-0936-RK	160
H10MB6150	104	HC-74/15	132	JAB-1017	164	JAI-0938	160
H10MB8200	104	HC-74/76	132	JAB-1017-RK	164	JAI-0938-RK	161
H10MT08KV	37	HC-75/77	132	JAB-1018	164	JAI-0954	159
H10MT08SP	29	HC-76/12	132	JAB-1018-RK	164	JAI-1024	158
H10MT09S	104	HC-76/14	132	JAB-7003A	164	JAI-1024-RK	158
H10MT10100	105	HC-76/30	132	JAB-7003A-RK	164	JAI-1054	159
H10MT15100	105	HC-76/8	132	JAD	Pag.	JAI-1054-RK	159
H10MT20100	105	HC-78/15	132	JAD-0212	163	JAI-1114	158
H10MT25100	105	HC-80/15	132	JAD-0413	163	JAI-1114-RK	158
H10MT27150	105	HC-80/82	132	JAD-0413-RK	163	JAI-1114K	158
H10MT30150	105	HC-86/16	132	JAD-1015-RK	164	JAI-1124	158
H10MT40150	105	HC-86/18	132	JAD-1015K	164	JAI-1124-RK	158
H10MT45200	105	HC-9.5mm	132	JAD-1020	163	JAI-1138	161
H10MT50200	105	HC-90/15	132	JAD-1020-RK	163	JAI-1138-RK	161
H12	Pag.	HC-92/10	132	JAD-1021	163	JAI-1138L	161
H12S09085	105	HC-93/15	132	JAD-1021-RK	163	JAI-1206L	160
H12S10090	105	HC-93/36	132	JAD-1027	163	JAI-1206L-RK	160
H12S110S	105	HC-93/45	132	JAD-1027-RK	163	JAI-1232-RK	159
H12S15100	105	HC-95/15	132	JAD-6252A	164	JAI-1232K	159
H12S20115	105	HC-96/18	132	JAD-6252A-RK	164	JAI-1408	161
H12S25130	105	HV	Pag.	JAG	Pag.	JAI-1408-RK	161
H12S27145	105	HV1000V-BLACK	12	JAG-0903-MS	164	JAI-1408L	161
H12S30165	105	HV1000V-C	12	JAG-0906R/RM-RK	165	JAI-1513	159
H12S40185	105	HV1000V-GREEN	12	JAG-0906RMK	165	JAI-1513-RK	159
H12S45205	105	HV1000V-V	12	JAG-0913RM-RK	165	JAI-1514	159
H12S50230	105	JA	Pag.	JAG-0913RMK	165	JAI-1514-RK	159
H15	Pag.	JA-0001RK	170	JAG-0923RM	165	JAI-1524	158
H15M105S	105	JA-300C-NS13	169	JAG-0923RM-RK	165	JAI-6202-RK	161
H20	Pag.	JA-3806C	170	JAG-0925RM	165	JAI-6211	160
H20MB1037S	106	JA-3808A	170	JAG-0925RM-RK	165	JAI-6211-RK	160
H20MT08SP	29	JA-3812A	175	JAG-0955RM	165	JAI-6212-RK1	160
H20MT09S	106	JA-3812D	175	JAG-0955RM-RK	165	JAI-6212K	160
H20MT10	105	JA-5032	175	JAG-1087	166	JAR	Pag.
H20MT15	105	JA-6111-NS	169	JAG-1087-RK	166	JAR-1012	162
H20MT20	105	JA-6111-NS17	169	JAG-6638	166	JAR-1012-RK	162
H20MT25	105	JA-6111-NS20	169	JAG-6638-RK	166	JAR-1013	162
H20MT27	105	JA-6111(1.4)	169	JAG-6639	166	JAR-1013-RK	162
H20MT30	105	JA-6111K	169	JAG-6639-RK	166	JAR-1033	163
H20MT40	105	JA-7253	176	JAH	Pag.	JAR-1033-RK	163
H20MT45	105	JA-7254	176	JAH-0288	174	JAR-1094-RK	162
H20MT50	105	JA-950	171	JAH-0288-15	174	JAR-6309A-RK	162
H22	Pag.	JA-950-04	171	JAH-0288-16	174	JAR-6309AK	162
H22S109S	106	JA-960	171	JAH-0288-17	174	JAR-6310A	162
				JAH-0288-RK	174	JAR-6310A-RK	162
						JAR-6310AK	162

JAS	Pag.	JAT-12F3	171	JAZ-0513	177	M10	Pag.
JAS-0010	167	JAT-12F4	171	JAZ-0513-50	176	M10110	152
JAS-0010-41	167	JAT-20T14	171	JAZ-0514	177	M10210A	152
JAS-0010-RK	167	JAT-20T18	171	JAZ-0514-09	176	M10210B	152
JAS-0413	167	JAT-20T24	171	JAZ-0514-48	176	M10410A	152
JAS-0413-RK	167	JAT-460	175	JAZ-3811E	175	M10410B	152
JAS-0423-RK	167	JAT-480	175	JAZ-39520	176	M11	Pag.
JAS-0423K	167	JAT-480-NS	175	JAZ-6704-O	177	M11035	107
JAS-0452	171	JAT-501	175	JAZ-6704-W	177	M11045	107
JAS-0452-RK	171	JAT-6004K	175	JAZ-6704A	177	M11065	107
JAS-1021-6HE-RK	167	JAT-6034	174	JAZ-6710A	177	M29	Pag.
JAS-1021-6HE(2.5)	167	JAT-6034-1A	174	JAZ-6711A	177	M2927	107
JAS-1031-6HE	168	JAT-6034-1B	174	JAZ-6712A	177	M2927-T1	107
JAS-1031-6HE-RK	168	JAT-6034-1C	174	JAZ-6715A	177	M2927-T2	107
JAS-1031-6HP	168	JAT-6034-1D	174	JAZ-7207	164	M2932	107
JAS-1031-6HP	169	JAT-6034-RK	174	JAZ-7214F	177	M2932-T1	107
JAS-1031-6VE-RK	168	JAT-6412	173	JAZ-7214S	177	M2932-T2	107
JAS-1206-6HE	167	JAT-6412-RK	173	JAZ-7214Z	177	M2940	107
JAS-1206-6HE-RK	167	JAT-6421	172	JAZ-ST4	183	M2940-T1	107
JAS-1206-6HP	168	JAT-6421-33	172	JW	Pag.	M2940-T2	107
JAS-1206-6HP	168	JAT-6421-RK	172	JW-01B	180	M2950	107
JAS-1207-6HE	168	JAT-6441-RK	173	JW-BACKPACK	181	M2950-T1	107
JAS-1207-6HE-56	168	JAT-6441K	173	JW-OPENER	183	M2950-T2	107
JAS-1207-6HE-57	168	JAT-6613	172	JW-USB	181	M2960	107
JAS-1207-6HE-RK	168	JAT-6613-P	172	M01	Pag.	M60	Pag.
JAS-6505	166	JAT-6613-PA	172	M01016	107	M60103	108
JAS-6505-RK	166	JAT-6613-RK	172	M01020	107	M60104	108
JAS-6531	168	JAT-6673	174	M03	Pag.	M60105	108
JAS-6531-RK	168	JAT-6673-RK	174	M03025	107	M61	Pag.
JAS-6535-5HE	168	JAT-6676	172	M04	Pag.	M61110	108
JAS-6535-5HE-47	169	JAT-6676-RK	172	M04008	107	M61112	108
JAS-6535-5HE-RK	168	JAT-6904S	176	M04012	107	M61113	108
JAS-6535-5VE-RK	169	JAT-6905-C	176	M04016	107	M61116	108
JAS-6535-6HE	169	JAT-6905-J	176	M04016	107	M61119	108
JAS-6535-6HE-RK	169	JAT-6905B	176	M04024	107	M61122	108
JAS-6542	171	JAT-6905S	176	M04032	107	M61125	108
JAS-6542-RK	171	JAT-6943A	173	M05	Pag.	M61H116	109
JAS-6543	171	JAT-6943A-RK	173	M05020	107	M61H119	109
JAS-6543-RK	171	JAT-6952	173	M06	Pag.	M61H124	109
JAS-6551	166	JAT-6952-RK	173	M06030	107	M62	Pag.
JAS-6551-RK	166	JAT-6952P	173	M06040	107	M62102	108
JAS-6552	166	JAT-6952P-37	173	M07	Pag.	M62103	108
JAS-6552-RK	166	JAT-6952P-39	173	M07016	107	M62104	108
JAT	Pag.	JAT-6952P-40	173	M07016-ACE	107	M62105	108
JAT-1011	172	JAT-6952P-RK	173	M07016-TPR	107	M62106	108
JAT-1011-RK	172	JAT-6959	176	M09	Pag.	M62108	108
JAT-1020-RK	171	JAT-6959A	176	M09100	107	M62H102	109
JAT-1020K	171	JAZ	Pag.	M091000	107	M62H103	109
JAT-1035	175	JAZ-0001B	176	M09103KV	37	M62H104	109
JAT-1035-RK	175	JAZ-0002A	176	M09200	107	M62H106	109
JAT-1041	172	JAZ-0002B	176	M09300	107	M63	Pag.
JAT-1041-16S	172	JAZ-0002C	176	M09500	107	M63102	108
JAT-10T18	172	JAZ-0042	176	M09513SP	30	M63103	108
JAT-10T32	172	JAZ-011H	174	M09800	107	M63104	108
JAT-12F1	171	JAZ-016H	174			M63105	108
JAT-12F2	171	JAZ-0512	177				

M63106	108	MG010009	148	MTC	Pag.	P-TR(AG010026SP)	43
M63106S	109	MG020001	149	MTC101SP	30	P-TR(AI10002SP)	43
M63108	108	MG020003	149	MTC1150	110	P-TR(D70105SP)	43
M63113KV	37	MG020004	149	MTC1200	110	P-TR(D71PP08SP)	43
M63H103	109	MG020006	149	MTC1300	110	P-TR(H10MB08SP)	43
M63H105	109	MG020007	149	MTC153	110	P-TR(M09513SP)	43
M63H106	109	MG020008	149	MTC156	110	P-TR(M645114SP)	43
M63H108	109	MHS	Pag.	MTC200	110	P-TR(P04704SP)	43
M63M106S	109	MHS08KV	37	MTC306	110	P-TR(P0803SP)	43
M64	Pag.	MHS100AG	110	MTC308	110	P-TR(P0903SP)	43
M64105	108	MIO	Pag.	MTC408	111	P-TR(S03A4122SP)	43
M64105S	109	MI010014	149	MTC508	111	P-TR(S04H2125SP)	43
M645114SP	30	MI010016	149	MTM	Pag.	P-TR(S04H3157SP)	43
M64M105S	109	MI010017	149	MTM1025	111	P-TR(S04H3536SP)	43
ME0	Pag.	MI010018	149	MTM1050	111	P-TR(S04H4125SP)	43
ME010001	148	MI010019	149	MTM1075	111	P-TR(S04H4524SP)	43
ME010007	148	MI010020	149	MTM1100	111	P-TR(S04H4726SP)	43
ME010009	148	MI010021	149	P-B	Pag.	P-TR(S04H4728SP)	43
ME010010	148	MI020001	149	P-B (31)	43	P-TR(S06H427SP)	43
ME010012	148	MI020002	149	P-B (41)	43	P-TR(S09H4118SP)	43
ME020001	148	MI020004	149	P-EVA	Pag.	P-TR(S29H4140SP)	43
ME020002	148	MK2	Pag.	P-EVA(D70105KV)	41	P-TR(W23108SP)	43
ME020003	148	MK2040	110	P-EVA(D71PP08KV)	41	P-TR(W25110SP)	43
ME020005	148	MK2040-B	110	P-EVA(D737128SV)	41	P-TR(W26112SP)	43
ME020006	148	MK2080	110	P-EVA(D737134SV)	41	P-TR(W26116SP)	43
MEC	Pag.	MKS	Pag.	P-EVA(H10121SV)	41	P01	Pag.
MEC PESADOS 20A	17	MKS27-12	110	P-EVA(H10MB08KV)	41	P0118	88
MEC PESADOS 20B	17	MKS27-16	110	P-EVA(H10MT08KV)	41	P011804KV	37
MEC POWER 19C	9	MKS27-16A	110	P-EVA(M09103KV)	41	P018	86
MEC POWER 19V	9	MKS27-20	110	P-EVA(M63113KV)	41	P018SP	30
MEC PROF20-BLACK	10	MKV	Pag.	P-EVA(MHS08KV)	41	P018SP1	30
MEC PROF20-C	10	MKV7	113	P-EVA(P011804KV)	41	P03	Pag.
MEC PROF20-GREEN	10	MKV7-K	113	P-EVA(P32M105KV)	41	P038	86
MEC PROF20-V	10	MKV8	113	P-EVA(P82714SV)	41	P04	Pag.
MEC SOLUTION BLACK	8	MNO	Pag.	P-EVA(P82736SV)	41	P046	86
MEC SOLUTION GREEN	8	MNO20004	149	P-EVA(S03A4122KV)	42	P04704SP	30
MEC SOLUTION-C	8	MNO20005	150	P-EVA(S04H2132KV)	42	P05	Pag.
MEC SOLUTION-V	8	MSH	Pag.	P-EVA(S04H4144KV)	42	P0516	88
MF0	Pag.	MSH1214	74	P-EVA(S04H42165SV)	42	P0518	88
MF05A	109	MSH1414	74	P-EVA(S04H4295SV)	42	P06	Pag.
MF05B	109	MSH3814	74	P-EVA(S04H45121SV)	42	P068	86
MF05C	109	MT0	Pag.	P-EVA(S29H4141KV)	42	P068A	86
MF05D	109	MT010001	150	P-EVA(W23559SV)	42	P07	Pag.
MF05E	109	MT010002	150	P-EVA(W25110KV)	42	P079	86
MF05S	109	MT010003	150	P-EVA(W25116KV)	42	P08	Pag.
MFM	Pag.	MT010004	150	P-EVA(W26116KV)	42	P0803SP	30
MFM06S	109	MT010005	150	P-EVA(W26134SV)	42	P08104S	89
MGO	Pag.	MT010006	150	P-EVA(W2623431SV)	42	P0813SC	39
MG010001	148	MT010007	150	P-TR	Pag.	P0816	88
MG010002	148	MT010008	150	P-TR (D70SP06ST)	43	P0817	88
MG010003	148	MT0701	110	P-TR (PC303ST)	43	P0818	88
MG010004	148	MT0702	110	P-TR (S04H4120ST)	43	P09	Pag.
MG010005	148	MT0703	110	P-TR (S04H4506ST)	43	P0903SP	30
MG010006	148			P-TR (W26107ST)	43	P0916	88
MG010008	148			P-TR (W26920ST)	43	P0917	88
				P-TR(AG010002SP)	43	P0918	88

P10	Pag.	P36	Pag.	P78	Pag.	R12	Pag.
P1016	88	P36M06C	92	P7801	93	R1206N	45
P1017	88	P36M09A	91	P7802	93	R1206N-R	47
P1019	92	P36M09C	92	P7803	93	R1206R	47
P11	Pag.	P37	Pag.	P7804	93	R12081	45
P1116	88	P37M11A	91	P7805	93	R12081RK	47
P1118	88	P37M18A	91	P78M10C	92	R19	Pag.
P12	Pag.	P38	Pag.	P80	Pag.	R19H310S	77
P1216	88	P38M09A	91	P8006	87	R19H3110	77
P1218	88	P38M11A	91	P81	Pag.	R19H3111	77
P14	Pag.	P40	Pag.	P8106	87	R19H3112	77
P1416	88	P4016	88	P82	Pag.	R19H3113	77
P15	Pag.	P43	Pag.	P82714SV	34	R19H3114	77
P1516	88	P4318	89	P82736SV	34	R19H3115	77
P15808	89	P4318-RK	90	P90	Pag.	R19H3116	77
P17	Pag.	P4330	89	P9006	87	R19H3117	77
P178	89	P4330-RK	90	P94	Pag.	R19H3118	77
P18	Pag.	P52	Pag.	P9409	92	R19H3119	77
P1810	89	P52A10	92	P95	Pag.	R29	Pag.
P20	Pag.	P52B10	92	P9506	86	R2902	45
P2010LA	89	P52D12	92	P9508D	87	R2902RK	47
P2010RA	89	P52M10	92	P96	Pag.	R2903RK	47
P2010SA	89	P52N10	92	P9601	110	R2904	45
P22	Pag.	P53	Pag.	P9902S	87	R2904RK	47
P2205E	89	P53M06	92	PES	Pag.	R34	Pag.
P2208A	89	P53M11	92	PESD05	89	R3402RK	47
P2212A	89	P53M18	92	PESD10	89	R3403	46
P26	Pag.	P54	Pag.	PESD11	89	R3403RK	47
P266	86	P54M08A	92	PIN	Pag.	R3404RK	47
P27	Pag.	P54M10A	92	PINTOR20-BLACK	16	R35	Pag.
P2706	86	P60	Pag.	PINTOR20-C	16	R3502	46
P2710	86	P6008	86	PINTOR20-GREEN	16	R3504	46
P2710SP	30	P61	Pag.	PINTOR20-V	16	R36	Pag.
P2712	86	P6106	86	PSV	Pag.	R3602	46
P28	Pag.	P6108	86	PSV108SP	114	R3602RK	47
P2803SP	31	P64	Pag.	PSV110SC	114	R3603	46
P2810	86	P6424	90	PV0	Pag.	R3603RK	47
P28110	88	P71	Pag.	PV0118	113	R3604RK	47
P28112	88	P7101	87	PV0518	113	R37	Pag.
P28210	89	P7102	87	PV0816	113	R3702	46
P28212	89	P7103	87	PV0817	113	R3702B	46
P30	Pag.	P7104	87	PV0918	113	R3704	46
P30M07C	92	P7105	87	PV1	Pag.	R3704B	46
P30M10A	91	P76	Pag.	PV1016	113	R41	Pag.
P32	Pag.	P7601	90	PV1116	113	R4103	46
P32M03S	92	P7602	90	PV1118	113	R4104	46
P32M05C	92	P7603	90	PV1218	113	R45	Pag.
P32M07A	91	P7608	90	PV1416	113	R4502	46
P32M105KV	37	P77	Pag.	PV1516	113	R4502JRK	47
P32M10A	91	P7719	90	PV2	Pag.	R4502RK	47
P32M10C	92			PV28110	113	R48	Pag.
				PV4	Pag.	R4802A	46
				PV4006	114	R4802B	46
						R4802RK	47

R4804A	46	S03A4110	78	S03A6152	80	S03AD4112	78
R4804B	46	S03A4111	78	S03A6153	80	S03AD4113	78
R4804RK	47	S03A4111S	77	S03A6154	80	S03AD4114	78
R4811SC	39	S03A4112	78	S03A6155	80	S03AD4115	78
R51	Pag.	S03A4113	78	S03A6156	80	S03AD4116	78
R5103	46	S03A4114	78	S03A6157	80	S03AD4117	78
R5103RK	47	S03A4115	78	S03A6158	80	S03AD4118	78
R5104	46	S03A4116	78	S03A6159	80	S03AD4119	78
R5104RK	47	S03A4117	78	S03A6160	80	S03AD4121	78
R53	Pag.	S03A4118	78	S03A6163	80	S03AD4122	78
R53A-2A	77	S03A4119	78	S03A6165	80	S03AD4124	78
R53A-3A	77	S03A4121	78	S03A6167	80	S03AD4126	78
R53A-4A	77	S03A4122	78	S03A6170	80	S03AD4127	78
R58	Pag.	S03A4122KV	37	S03A6A4	81	S03AD4128	78
R5802ERK	47	S03A4122SP	31	S03A6A8	81	S03AD4130	78
R5803RK	47	S03A4123	78	S03A6E04	81	S03AD4132	78
R5804ERK	47	S03A4124	78	S03A6E08	81	S03AD4303S	85
R5804LRK	47	S03A4127	78	S03A6E10	81	S03AD4307S	85
R66	Pag.	S03A4129	78	S03A6U6	81	S03AD4317	85
R6602	47	S03A4130	78	S03A8109S	82	S03AD4319	85
R6603	47	S03A4132	78	S03A8124	82	S03AD4321	85
R6604	47	S03A4211S	79	S03A8127	82	S03AD4414S	79
R68	Pag.	S03A4A3	79	S03A8129	82	S03AD4503S	85
R6802	47	S03A4A6	79	S03A8130	82	S03AD4517	85
R6802RK	47	S03A4E4	79	S03A8132	82	S03AD4521	85
R6803	47	S03A4E5	79	S03A8133	82	S03AD6107S	81
R6803RK	47	S03A4E6	79	S03A8134	82	S03AD6120S	81
R6804	47	S03A4E8	79	S03A8135	82	S03AD6124	81
R6804RK	47	S03A4U4	79	S03A8136	82	S03AD6126	81
RD0	Pag.	S03A4UT	79	S03A8138	82	S03AD6127	81
RD01	47	S03A4UT3S	79	S03A8140	82	S03AD6129	81
RD01032S	99	S03A6108S	80	S03A8141	82	S03AD6130	81
RD02	47	S03A6126	80	S03A8144	82	S03AD6132	81
RV0	Pag.	S03A6127	80	S03A8146	82	S03AD6133	81
RV032	116	S03A6129	80	S03A8150	82	S03AD6134	81
RV033	116	S03A6130	80	S03A8155	82	S03AD6135	81
RV034	116	S03A6132	80	S03A8160	82	S03AD6136	81
S01	Pag.	S03A6133	80	S03A8165	82	S03AD6138	81
S01U4108S	78	S03A6134	80	S03A8170	82	S03AD6140	81
S01U4113	77	S03A6135	80	S03A8173	82	S03AD6141	81
S01U4114	77	S03A6136	80	S03A8175	82	S03AD6142	81
S01U4115	77	S03A6137	80	S03A8176	82	S03AD6144	81
S01U4116	77	S03A6138	80	S03A8178	82	S03AD6146	81
S01U4117	77	S03A6139	80	S03A8180	82	S03AD6150	81
S01U4119	77	S03A6140	80	S03A8185	82	S03AD8107S	82
S01U4121	77	S03A6141	80	S03A8189	82	S03AD8117	83
S01U4122	77	S03A6142	80	S03A8190	82	S03AD8124	83
S03	Pag.	S03A6143	80	S03A8192	82	S03AD8126	83
S03A2110	78	S03A6144	80	S03A8195	82	S03AD8127	83
S03A2112	78	S03A6145	80	S03A8A6	82	S03AD8129	83
S03A2114	78	S03A6146	80	S03A8E04	82	S03AD8130	83
S03A2UT	79	S03A6147	80	S03A8E07	82	S03AD8132	83
S03A3UT	79	S03A6148	80	S03A8E10	82	S03AD8133	83
S03A4109	78	S03A6149	80	S03AD4110	78	S03AD8134	83
		S03A6150	80	S03AD4111	78	S03AD8135	83
		S03A6151	80	S03AD4111S	79	S03AD8136	83

S03AD8138	83	S04H2112	62	S04H4129	63	S04H6356	65
S03AD8140	83	S04H2113	62	S04H4130	63	S04H6360	65
S03AD8141	83	S04H2114	62	S04H4131SP	32	S04H6365	65
S03AD8142	83	S04H2118S	57	S04H4132	63	S04H6419	65
S03AD8146	83	S04H2125SP	31	S04H4134	63	S04H6421	65
S03AD8148	83	S04H2132KV	38	S04H4136	63	S04H6422	65
S03AD8150	83	S04H2141S	57	S04H4144KV	38	S04H6424	65
S03AD8155	83	S04H2184SV	35	S04H42165SV	35	S04H6426	65
S03AD8158	83	S04H3106	62	S04H4295SV	35	S04H6427	65
S03AD8160	83	S04H3107	62	S04H4524S	58	S04H6429	65
S03AD8165	83	S04H3108	62	S04H4524SP	32	S04H6430	65
S03H2327S	57	S04H3109	62	S04H46121SV	35	S04H6432	65
S03S8117	83	S04H3110	62	S04H4726SP	32	S04H6433	65
S03S8119	83	S04H3111	62	S04H4728S	58	S04H6435	65
S03S8121	83	S04H3112	62	S04H4728SP	32	S04H6436	65
S03SD8117	83	S04H3113	62	S04H5129SC	40	S04H6438	65
S03SD8119	83	S04H3114	62	S04H524127S	61	S04H6440	65
S03SD8121	83	S04H3115	62	S04H52460S	60	S04H6441	65
S03V2106	114	S04H3116	62	S04H52477S	60	S04H6443	65
S03V2108	114	S04H3117	62	S04H52478S	60	S04H6444	65
S03V2110	114	S04H3118	62	S04H6115S	58	S04H6446	65
S03V2114	114	S04H3119	62	S04H6119	64	S04H6447	65
S03V3108	114	S04H3120	62	S04H6121	64	S04H6450	65
S03V3110	114	S04H3121	62	S04H6122	64	S04H6456	65
S03V3112	114	S04H3122	62	S04H6124	64	S04H8115S	59
S03V3113	114	S04H3124	62	S04H6127	64	S04H8355	66
S03V3114	114	S04H3125S	57	S04H6128	64	S04H8360	66
S03V3116SC	114	S04H3141S	58	S04H6130	64	S04H8365	66
S03V3117	114	S04H3157S	58	S04H6132	64	S04HD2106	62
S03V3119	114	S04H3157SP	31	S04H6134	64	S04HD2107	62
S03V3122	114	S04H3194SV	35	S04H6136	64	S04HD2108	62
S03V3136SV	115	S04H3536S	58	S04H6138	64	S04HD2110	62
S03V4110	114	S04H3536SP	31	S04H6141	64	S04HD2111	62
S03V4111	114	S04H4108	63	S04H6146	64	S04HD2112	62
S03V4112	114	S04H4109	63	S04H6150	64	S04HD2113	62
S03V4113	114	S04H4110	63	S04H6152	64	S04HD3109	63
S03V4114	114	S04H4111	63	S04H624101S	61	S04HD3110	63
S03V4117	114	S04H4112	63	S04H6319	65	S04HD3111	63
S03V4119	114	S04H4113	63	S04H6321	65	S04HD3112	63
S03V4120SC	115	S04H4114	63	S04H6321S	59	S04HD3113	63
S03V4122	114	S04H4115	63	S04H6322	65	S04HD3114	63
S03V4124	114	S04H4116	63	S04H6323	65	S04HD3115	63
S03V4124SV	115	S04H4117	63	S04H6324	65	S04HD3116	63
S03V4127	114	S04H4118	63	S04H6325	65	S04HD3117	63
S03V4132	114	S04H4119	63	S04H6326	65	S04HD3119	63
S04	Pag.	S04H4120	63	S04H6327	65	S04HD3120	63
S04H2104	62	S04H4121	63	S04H6329	65	S04HD3121	63
S04H21045	62	S04H4122	63	S04H6330	65	S04HD3124	63
S04H2105	62	S04H4123	63	S04H6332	65	S04HD4109	64
S04H21055	62	S04H4124	63	S04H6334	65	S04HD4110	64
S04H2106	62	S04H4125	63	S04H6336	65	S04HD4111	64
S04H2107	62	S04H4125S	58	S04H6338	65	S04HD4112	64
S04H2108	62	S04H4125SP	31	S04H6341	65	S04HD4113	64
S04H2109	62	S04H4126	63	S04H6346	65	S04HD4114	64
S04H2110	62	S04H4127	63	S04H6350	65	S04HD4115	64
S04H2111	62	S04H4128	63	S04H6355	65	S04HD4116	64

S04HD4117	64	S06A4T30	84	S07H325	69	S09H410	71
S04HD4118	64	S06A4T40	84	S07H327	69	S09H4109S	59
S04HD4119	64	S06A4T45	84	S07H330	69	S09H4118SP	32
S04HD411S	64	S06A4T50	84	S07H340	69	S09H412	71
S04HD4120	64	S06A4T55	84	S07H345	69	S09H414	71
S04HD4121	64	S06A4T60	84	S07H350	69	S09H416	71
S04HD4122	64	S06A4T70	84	S07H355	69	S09H417	71
S04HD4123	64	S06A4T80	84	S07H360	69	S09H419	71
S04HD4124	64	S06H204	68	S07H4109S	59	S09H4304	71
S04HD4125	64	S06H205	68	S07H420	69	S09H4305	71
S04HD4126	64	S06H206	68	S07H425	69	S09H4306	71
S04HD4127	64	S06H207	68	S07H427	69	S09H4307	71
S04HD4128	64	S06H208	68	S07H430	69	S09H4308	71
S04HD4130	64	S06H210	68	S07H4320	70	S09H4309	71
S04HD4132	64	S06H211	68	S07H4325	70	S09H4310	71
S05	Pag.	S06H306	68	S07H4327	70	S09H4312	71
S05A408S	84	S06H307	68	S07H4330	70	S09H4314	71
S05A4H10	83	S06H308	68	S07H4340	70	S09H4316	71
S05A4H12	83	S06H310	68	S07H4345	70	S09H4317	71
S05A4H14	83	S06H311	68	S07H4350	70	S09H4319	71
S05A4H17	83	S06H312	68	S07H4352	70	S09V3H4	115
S05A4H18	83	S06H314	68	S07H4355	70	S09V3H5	115
S05A4H4	83	S06H316	68	S07H4360	70	S09V3H6	115
S05A4H5	83	S06H318	68	S07H4370	70	S09V3H8	115
S05A4H6	83	S06H320	68	S07H440	69	S09V41H10	115
S05A4H7	83	S06H37S	66	S07H445	69	S09V41H4	115
S05A4H8	83	S06H410	68	S07H450	69	S09V41H5	115
S05A6105S	84	S06H411	68	S07H4530	70	S09V41H6	115
S05A6H14	84	S06H412	68	S07H4545	70	S09V41H8	115
S05A6H17	84	S06H4127S	59	S07H455	69	S10	Pag.
S05A6H19	84	S06H414	68	S07H460	69	S10H230	71
S05A6H22	84	S06H416	68	S07H470	69	S10H235	71
S05A6H24	84	S06H418	68	S07H4932S	59	S10H240	71
S05H4113S	66	S06H420	68	S08	Pag.	S10H245	71
S05H4213S	66	S06H422	68	S08H208S	99	S10H250	71
S05HD4110	66	S06H424	68	S08H311S	70	S10H255	71
S05HD4111	66	S06H425S	59	S09	Pag.	S10H260	71
S05HD4112	66	S06H427KV	38	S09H203	70	S10H270	71
S05HD4113	66	S06H427SP	32	S09H204	70	S10H3100	72
S05HD4113S	66	S06H49S	66	S09H205	70	S10H3120	72
S05HD4117	66	S07	Pag.	S09H206	70	S10H340	72
S05HD4118	66	S07H206	69	S09H207	70	S10H350	72
S05HD4119	66	S07H207	69	S09H303	70	S10H355	72
S05HD4120	66	S07H208	69	S09H304	70	S10H360	72
S05HD4121	66	S07H209	69	S09H305	70	S10H370	72
S05HD4122	66	S07H210	69	S09H306	70	S10H380	72
S05HD4123	66	S07H2138KV	38	S09H307	70	S10H4100	72
S05HD4124	66	S07H215	69	S09H308	70	S10H4110	72
S05HD4127	66	S07H220	69	S09H310	70	S10H4120	72
S05HD4130	66	S07H225	69	S09H312	70	S10H480	72
S05HD4132	66	S07H227	69	S09H314	70	S10H490	72
S05HD4213S	66	S07H230	69	S09H404	71	S11	Pag.
S06	Pag.	S07H240	69	S09H405	71	S11H200	72
S06A408S	84	S07H310	69	S09H406	71	S11H201	72
S06A4T20	84	S07H315	69	S09H407	71	S11H202	72
S06A4T27	84	S07H320	69	S09H408	71	S11H203	72

S11H300	72	S21	Pag.	S29	Pag.	S57H111	53
S11H301	72	S21H41125	75	S29H2133S	99	S57H112	53
S11H302	72	S21H41250	75	S29H2180S	102	S57H113	53
S11H303	72	S21H4150	75	S29H4140SP	32	S57H115	53
S11H304	72	S21H4175	75	S29H4141KV	38	S57H116	53
S11H402	72	S22	Pag.	S29TP23S	99	S57H117	53
S11H403	72	S22H21130	75	S40	Pag.	S57H118	53
S11H404	72	S22H21130RK	75	S40T108	76	S57H119	53
S12	Pag.	S22H31200	75	S40T109S	76	S57H121	53
S12A4525S	84	S22H41375	75	S40T110	76	S57H122	53
S14	Pag.	S22H41375RK	75	S40T112	76	S57H123	53
S14A4108S	99	S22H41450	75	S40T113	76	S57H124	53
S14A4117	99	S22H41600	75	S40T114	76	S57H125	53
S14A4118	99	S22H41600RK	75	S40T117	76	S57H127	53
S14A4120	99	S22H6500	75	S40T119	76	S60	Pag.
S14A4121	99	S22H6500RK	75	S41	Pag.	S60H4304S	77
S14A4123	99	S23	Pag.	S41H41	76	S63	Pag.
S14A4124	99	S23H21115	76	S42	Pag.	S63H3306	73
S14A4126	99	S23H31200	76	S42M403S	77	S63H3308	73
S14A4127	99	S23H41250	76	S42M4125	76	S63H3310	73
S15	Pag.	S23H41250	76	S42M4250	76	S63H4132S	59
S15H240	74	S23H41300	76	S42M475	76	S63H4306	73
S15H356	74	S23H6450	76	S43	Pag.	S63H4308	73
S15H472	74	S23H6500	76	S43V38	116	S63H4310	73
S15H6109	74	S23H8550	76	S43V48	116	S63H4312	73
S16	Pag.	S24	Pag.	S44	Pag.	S63H4313	73
S16H1234	75	S24H2100	76	S44H2206	77	S63H4405	73
S16H1238	75	S24H2150	76	S44H3110A	77	S63H4407	73
S16H1438	75	S24H250	76	S44H3206	77	S63H4408	73
S16H302	75	S24H3150	76	S46	Pag.	S63H4409	73
S16H304	75	S24H3200	76	S46TE80	85	S63H4410	73
S16H3410	75	S24H3250	76	S49	Pag.	S63H4412	73
S16H3412	75	S24H375	76	S49H4105	73	S63H4413	73
S16H3812	75	S24H4125	76	S49H4106	73	S63H4414	73
S16H3814	75	S24H4224	76	S49H4108	73	S63H4507S	73
S16H403	75	S24H4250	76	S49H4110	73	S63H4605	73
S17	Pag.	S24H450	76	S49H4112	73	S63H4606	73
S17H3116	75	S24H475	76	S49H4114	73	S63H4607	73
S17H3121	75	S24H6100	76	S49H4116	73	S63H4608	73
S17H3414	75	S24H6200	76	S49H4116	73	S63H4609	73
S17H4116	75	S24H6400	76	S49H4308	73	S63H4610	73
S17H4121	75	S24H6400	76	S49H4310	73	S63H4612	73
S18	Pag.	S24H8200	76	S49H4312	73	S63H4613	73
S18A4103MS	84	S25	Pag.	S49H4314	73	S63H4614	73
S18A4115	85	S25V310	115	S49H4318	73	S63H4708	74
S18A4117	85	S25V36	115	S50	Pag.	S63H4709	74
S18A4117M	84	S25V410	115	S50H3106S	73	S63H4710	74
S18A4119	85	S25V45	115	S50H3206S	73	S63H4712	74
S18A4119M	84	S26	Pag.	S54	Pag.	S63H4713	74
S18A4121	85	S26H2150	76	S54H5509S	73	S63H4714	74
S18A4121M	84	S26H2280	76	S57	Pag.	S63H4808	74
S18AD4117	85	S27	Pag.	S57H108	53	S63H4809	74
S18AD4119	85	S27H2	76	S57H108S	53	S63H4810	74
S18AD4121	85	S27H3	76	S57H109	53	S63H4812	74
		S27H4	76	S57H110	53	S63H4813	74
						S63H4814	74

S64	Pag.	S66HD4111	67	T10316	44	T27010N	44
S64A4106S	84	S66HD4112	67	T10317	44	T27020N	44
S64A6306S	84	S66HD4113	67	T10318	44	T27060N	44
S64H4104	74	S66HD4114	67	T10319	44	T271001N	44
S64H4105	74	S66HD4115	67	T10321	44	T27101N	44
S64H4106	74	S66HD4116	67	T10322	44	T27200N	44
S64H4107	74	S66HD4117	67	T10324	44	T27340N	44
S64H4109	74	S66HD4118	67	T10H1210S	44	T27800N	44
S64H4113	74	S66HD4119	67	T14	Pag.	T29	Pag.
S64H4126S	60	S66HD4120	67	T14100N	45	T29002	44
S64H4204	74	S66HD4121	67	T14200N	45	T29014	44
S64H4205	74	S66HD4122	67	T15	Pag.	T30	Pag.
S64H4206	74	S66HD4123	67	T154100N-R	45	T30200NS	44
S64H4207	74	S66HD4124	67	T154200N-R	45	T33	Pag.
S64H4208	74	S66HD4127	67	T16	Pag.	T33025N	44
S64H4209	74	S66HD4130	67	T16005N-R	45	T33050N	44
S64H4210	74	S66HD4132	67	T19	Pag.	T33050N-R	45
S64H4212	74	S68	Pag.	T19135N	45	T33101N	44
S64H4214	74	S68H2103	56	T19200N	45	T33101N-R	45
S64H4216	74	S68H2104	56	T21	Pag.	T33200N-R	45
S64H4218	74	S68H21045	56	T21025N	44	T33341N	44
S64H4705	74	S68H2105	56	T21025N-R	45	T33341N-R	45
S64H4706	74	S68H21055	56	T21050N	44	T35	Pag.
S64H4708	74	S68H2106	56	T21050N-R	45	T351060	47
S64H4709	74	S68H21065	56	T211000N	44	V10	Pag.
S64H4710	74	S68H2107	56	T211000N-R	45	V1001	90
S64H4712	74	S68H2108	56	T21101N	44	V1002	90
S64H4714	74	S68H2109	56	T21101N-R	45	V1002-RK	90
S64H4808	74	S68H2110	56	T21200N	44	V1003	90
S64H4810	74	S68H2111	56	T21200N-R	45	V1005	90
S64H4812	74	S68H2112	56	T21340N	44	V11	Pag.
S64H4814	74	S68H2113	56	T21340N-R	45	V11011SC	40
S66	Pag.	S68H2114	56	T21341N	44	V1103	90
S66H4108	67	S68H2141S	56	T21341N-R	45	V13	Pag.
S66H4110	67	S68H4127S	56	T21550N	44	V1310A	91
S66H4111	67	S68H5234111S	56	T21550N-R	45	V1310A-11	91
S66H4112	67	T04	Pag.	T24	Pag.	V1310B-11	91
S66H4113	67	T04M060-R	45	T24135	45	V1310C	91
S66H4114	67	T04M061-R	45	T24135-R	45	V1310E-11	91
S66H4115	67	T04M150-R	45	T24200	45	V1310F	91
S66H4116	67	T04M250-R	45	T24200-R	45	V1310F-11	91
S66H4117	67	T07	Pag.	T25	Pag.	V1310G-11	91
S66H4118	67	T07030N-R	45	T25100N	44	V1310J-11	91
S66H4119	67	T07110N-R	45	T25100N-R	45	V1311E	91
S66H4120	67	T07700N-R	45	T25200N	44	V1311SP	33
S66H4121	67	T09	Pag.	T25200N-R	45	V14	Pag.
S66H4122	67	T094602	47	T25340N	44	V1401	91
S66H4124	67	T094602-RK	47	T25340N-R	45	V1403	91
S66H4125	67	T096801	47	T27	Pag.	V15	Pag.
S66H4126	67	T096801-RK	47	T27-D2R	45	V1501	91
S66H4127	67	T10	Pag.	T27-D3R	45	V1505	91
S66H4128	67	T102001S-R	45	T27-D4R1	45	V21	Pag.
S66H4130	67	T10313	44	T27-D4R2	45	V2101	90
S66H4132	67	T10314	44	T27-D6R	45	V2102	90
S66H4136	67	T10315	44	T27-D8R	45		

V24	Pag.	W24N1113	51	W26112	52	W28	Pag.
V2401	90	W24N1214	51	W26112S	52	W2808	55
V2401-M10A	90	W24N1719	51	W26112SP	33	W2810	55
V2401-M10B	91	W25	Pag.	W26113	52	W2810RJ-HL	55
V2401-M5A	90	W250607	51	W26114	52	W2812	55
V2401-M5B	91	W250608	51	W26114S	52	W2812RJ-HL	55
V2401-M6A	90	W250809	51	W26115	52	W2814	55
V2401-M6B	91	W251011	51	W26116	52	W2814RJ-HL	55
V2401-M8A	90	W251012	51	W26116KV	39	W2818	55
V2401-M8B	91	W25106KV	38	W26116SP	33	W2818RJ-HL	55
W23	Pag.	W25107KV	38	W26117	52	W2824	55
W230607	51	W25108S	51	W26118	52	W2824RJ-HL	55
W230809	51	W25110KV	39	W26119	52	W2836	55
W231011	51	W25110SP	33	W26120	52	W2836RJ-HL	55
W23108S	51	W25117SC	40	W26121	52	W28HD10	55
W23108SP	33	W251213	51	W26122	52	W28HD8	55
W231213	51	W251415	51	W26123	52	W29	Pag.
W231415	51	W251417	51	W26124	52	W290608	52
W231617	51	W251617	51	W26125	52	W290711	52
W231819	51	W251719	51	W26126	52	W291012	52
W232022	51	W251819	51	W26126S	52	W291418	52
W232123	51	W252022	51	W26127	52	W291622	52
W232426	51	W252123	51	W26128	52	W292024	52
W232427	51	W252426	51	W26129	52	W39	Pag.
W232528	51	W252427	51	W26130	52	W391011	52
W233032	51	W252528	51	W26132	52	W39108SA	52
W23559SV	36	W252730	51	W26134	52	W391213	52
W23V108	116	W252732	51	W26134SV	36	W391415	52
W23V110	116	W253032	51	W26136	52	W391617	52
W23V111	116	W253236	51	W26138	52	W391819	52
W23V112	116	W253641	51	W26141	52	W43	Pag.
W23V113	116	W253842	51	W26142	52	W43A106S	53
W23V114	116	W254146	51	W26144	52	W45	Pag.
W23V116	116	W254650	51	W26146	52	W45108	48
W23V117	116	W25V108	116	W26148	52	W45109	48
W23V118	116	W25V109	116	W26150	52	W45110	48
W23V119	116	W25V110	116	W26155	52	W45110S	48
W23V121	116	W25V1125SV	116	W26160	52	W45111	48
W23V122	116	W25V113	116	W26165	52	W45112	48
W23V124	116	W25V114	116	W2623431SV	36	W45112SP	33
W24	Pag.	W25V117	116	W26315SV	36	W45113	48
W240809	51	W25V118	116	W26411PRS	52	W45114	48
W241011	51	W25V119	116	W26414S	52	W45115	48
W241012	51	W25V121	116	W27	Pag.	W45116	48
W24106S	51	W25V122	116	W27AL10	54	W45117	48
W241314	51	W25V124	116	W27AR10	55	W45117S	48
W241417	51	W26	Pag.	W27AR8	55	W45118	48
W241617	51	W26106	52	W27AS10	55	W45118	48
W241719	51	W26107	52	W27AS15	55	W45119	48
W241819	51	W26108	52	W27AS18	55	W45121	48
W241922	51	W26108KV	39	W27AS8	55	W45122	48
W242528	51	W26109	52	W27AT02SC	40	W45124	48
W243032	51	W26110	52	W27AT10	55	W45127	48
W24A107S	47	W26110KV	39	W27AT12	55	W45130	48
W24A109SP	33	W26111	52	W27AT15	55	W45132	48
W24N0810	51			W27AT8	55	W45316S	48

W45316S-AD	48	W66	Pag.	W72	Pag.	W84	Pag.
W45316S-AD12	48	W66107S	49	W72117	54	W84106	57
W45316S-AD14	48	W66108	49	W72118	54	W84107	57
W45316S-AD34	48	W66109	49	W72119	54	W84108	57
W45316S-AD38	48	W66110	49	W72121	54	W84108S	56
W45316S-ADBH14	48	W66111	49	W72122	54	W84109	57
W47	Pag.	W66112	49	W72124	54	W84110	57
W47108SP	33	W66113	49	W72127	54	W84111	57
W51	Pag.	W66114	49	W72130	54	W84112	57
W51110S	48	W66115	49	W72132	54	W84113	57
W52	Pag.	W66116	49	W72134	54	W84114	57
W52105S	49	W66116S	49	W72136	54	W84114S	56
W60	Pag.	W66117	49	W72141	54	W84115	57
W60115SP	33	W66118	49	W72146	54	W84116	57
W61	Pag.	W66119	49	W72150	54	W84117	57
W611011	50	W66124	49	W72155	54	W84118	57
W61106S	50	W67	Pag.	W72170	54	W84119	57
W611214	50	W67104S	49	W73	Pag.	W86	Pag.
W611315	50	W67119	54	W73102S	49	W86112S	57
W611618	50	W67121	54	W7310813	49	W91	Pag.
W611719	50	W67124	54	W7311419	49	W91107S	50
W612224	50	W67130	54	W77	Pag.	W91110	50
W62	Pag.	W67132	54	W77A124	54	W91112	50
W6210607	50	W67136	54	W77A127	54	W91113	50
W6210809	50	W67138	54	W77A130	54	W91114	50
W62108S	50	W67141	54	W77A132	54	W91115	50
W6211011	50	W67145	54	W77A136	54	W91117	50
W6211213	50	W67146	54	W77A138	54	W91119	50
W6211415	50	W67150	54	W77A141	54	W93	Pag.
W6211617	50	W67155	54	W77A146	54	W93110	50
W6211819	50	W67160	54	W77A150	54	W93111	50
W6212022	50	W67165	54	W77A155	54	W93112	50
W6212427	50	W67170	54	W77A160	54	W93113	50
W6212528	50	W68	Pag.	W77A165	54	W93114	50
W6213032	50	W680809	49	W77H01	54	W93115	50
W65	Pag.	W680810	49	W77H02	54	W93117	50
W65105KV	39	W681011	49	W77H03	54	W93119	50
W6510810	53	W68106S	49	W77H04	54	WV2	Pag.
W6511012	53	W681213	49			WV27AS10	116
W6511315	53	W681415	49				
W6511417	53	W681618	49				
W6511922	53	W681719	49				
W65A1012	53	W69	Pag.				
W65A105S	53	W69116S	53				
W65A1214	53	W70	Pag.				
W65A1315	53	W70A118S	33				
W65A1618	53						
W65A1719	53						
W65A1922	53						
W65A2224	53						

ARTIGO	PÁG.	ARTIGO	PÁG.
Acessórios de ar comprimido	176 a 178	Chave de tubos combustível	131
Acessórios para carros ferramenta	24, 25	Chave de velas	75, 134
Alavancas de chapeiro	152	Chave inglesa	54, 55
Alicate anéis de segurança	131	Chave luneta	50, 51, 53
Alicate ajustável	86, 89	Chave mista	52, 53
Alicate anti estático	89	Chave com roquete	48 a 50
Alicate corta cabos	89, 90	Chave para bujão óleo	131, 133
Alicate de cravar terminais	91	Chave pata de galo	77
Alicate de descarnar	91	Chaves alternador	127
Alicate de freios	86, 87	Chave cavilhas e encaixes plásticos	151, 152
Alicate de pressão	91 a 93	Chaves de caixa	62 a 68
Alicate de rebitar	90	Chaves de fenda	94 a 98
Alicate para abraçadeiras	140, 141	Chaves de filtros	132 a 134
Alicates (universal, pontas, corte)	86 a 90	Chaves de impacto	77 a 85
Alicates para tubos	131, 137	Chaves de velas incandescência	129
Alicate para tubos escape	138	Chaves dinamométricas	44 e 45
Alicate tensor abraçadeiras	137	Chaves em L hexagonais	102 a 106
Alicates travões	137	Chaves em L Torx	104 a 106
Apalpa folgas	135	Chaves em T com ponta flexível	76
Aparafusadora pneumática	164	Chaves Phillips	94 a 98
Armários oficinais	18 a 20	Chaves Pozi	96 a 98
Aparadeira óleo	122 e 189	Chave remoção frisos/ plásticos	150
Assentador pneumático de válvulas	172	Chave remoção vidros/ pábrabras	150
Balanceros	175	Chaves retirar fêmeas danificadas	128 e 139
Bancada de trabalho	189	Chave de rodas em cruz	124
Banco de apoio	187	Chaves sensor oxigénio	134
Bandeja magnética	123	Chaves SuperTech	56, 57
Berbequim pneumático	163, 164	Chaves Torx	96, 97
Bits de caixa	69 a 74	Chaves Torx plus	99
Bits e porta bits	98 a 102	Chave para terminais	126
Bomba de massa	175	Compasso	110, 111
Bomba hidropneumática	186	Compressor molas	121
Cabo articulado (rabo de força)	75	Corta tubos	139
Cabo T corrediço	76	Cunhas chapeiro	152
Cabos arranque de bateria	140	Densímetro	140
Caixas de ferramenta	23	Desandadores	153, 154
Caneta magnética	123	Despolidor de cilindros	139
Cardan	74	Encontrador de chapeiro	152
Carros e caixas vazios	20 a 23	Enroladores de ar	176
Carros e composições de ferramenta	7 a 17	Estrado de mecânico	187
Centrador embraiagens	137	Esquadro metálico	110
Chave bocas	51, 52	Extensões	75 a 77
Chave de barra direção	138	Extratores	119 a 121
Chave de bocas perfil fino	52	Faca pneumática	173
Chave de cachimbo	53	Ferramenta isolada 1000Volts	112 a 116
Chave de injetores	126, 129	Ferramenta para correias	134, 135
Chave de pancada (bocas e luneta)	54	Ferramenta para travões	136, 137
Chave de tubos	55	Ferramenta rodar válvulas	130

ARTIGO	PÁG.	ARTIGO	PÁG.
Ferramentas chapeiro	150 a 154	Ponteira para válvula pneum	123
Ferramentas especiais mecânica	118 a 141	Porta bits	77
Ferramentas especiais motas	148 a 150	Preguiças	118
Ferramentas especiais pesados	155, 156	Prensas de chapeiro	188
Ferramentas especiais por marca	141 a 147	Punções	108, 109
Ferro de desmonta	138	Punho para chave caixa	76
Filtros de ar	177	Raspadores/ riscadores	130
Fita métrica	110	Rebarbadora pneumática	166
Funil para óleos e refrigerante	135	Rebitadora pneumática	174, 175
Gambiarra sem fios	111	Rectificadora pneumática	165, 166
Grampo segmentos	127	Reduções	75
Grampo válvulas	127	Refratómetro	122
Grua hidráulica	187	Régua metálica	110
Jogo de bits	98, 99	Reparador de roscas	135, 136 e 138
Jogo chaves caixa com roquete	57 a 61	Roquete pneumático	162, 163
Kit comando motores	125, 126, 141 a 147	Roquetes	45 a 47
Kit remoção de rádios	141	Saca casquilhos	123
Limas	109	Saca injectores	130
Lixadora pneumática	165 a 169	Sacas	119 a 121
Macaco de chapeiro	188	Sangrador travões	119 e 130
Macaco de fossa/ transmissões	186	Seringa	122
Macaco de rodas/ hidropneumático	187	Serra	110
Machos e caçonetos	28, 38, 124	Serra pneumática	171, 172
Mala de electricista	140	Suporte de motores	187
Mala de ferramenta	60, 61	Suporte para chaves caixa	74
Máquina decapar pneumática	172	Tabuleiros ferramenta (caixa plástico)	28 a 33 e 39 a 40
Máquina descravar pneumática	164	Tabuleiros ferramenta (EVA)	34 a 39
Máquina pneumática impacto	158 a 161	Tabuleiros vazios	41 a 43
Martelo pneumático	174	Tesoura	89
Martelos	107	Tesoura pneumática	173
Martelos de chapeiro	152, 153	Teste atuadores	140
Medidor angular de torque	124	Teste compressão/ pressão	128 e 140
Medidor de passo de rosca	124	Teste de vácuo/ pressão	130
Medidor de profundidade	138, 139	Teste fluido travões	140
Medidor de pressão pneum	123	Teste fluxo e retorno injectores	128
Merchandising	180 a 183	Teste pressão radiadores	118
Micrómetro	111	Teste turbo	129
Molas de plástico	156	Tira mossas	153
Multímetros	189	Tomadas de ar	177, 178
Organizador de peças	127	Torno de bancada	25
Paquímetro	110	Travessa para portas	188
Pesca magnético	123	Travessa para motores	187, 188
Pinça amperimétrica	189	Tubo espiral para ar	177
Pinças de chapeiro	153, 154	Turquês	89
Pistola de pintura	169, 170	Ventosas	151
Pistola vaporizadora (tornado)	122	Verificador altura calços travão	137
Pistoletes ar/ água	176	Verificador fugas cabeça cilindro	122
Polidora pneumática	166, 167	X-ato/ navalha	110



Com ferramentas pneumáticas não utilizar chaves de caixa, juntas universais ou outras ferramentas de uso manual.



Não utilizar martelos ou tubos para aumentar o binário em chaves de aperto, chaves dinamométricas e roquetes.



Não utilizar chaves de parafusos como alavanca, punção ou escopro. Existem séries especiais de chaves de parafusos que podem ser marteladas.

Ferramentas Manuais

- Deverá ter bastante cuidado ao utilizar qualquer ferramenta, mantendo-a afastada das crianças.
- Recomenda-se utilizar sempre máscaras, óculos, auriculares e luvas de proteção (se aplicável).
- Deverá desligar sempre a energia elétrica antes de efetuar trabalhos em qualquer tipo de máquina ou equipamento elétrico ou junto de superfícies condutoras, pois poderão ocorrer choques elétricos. Nestes casos, utilizar sempre ferramentas isoladas.
- Deverá escolher o tipo e tamanho correto da ferramenta para o trabalho a realizar. As unidades de medida servem para selecionar a ferramenta com tamanho certo.
- Deverá manter as ferramentas limpas.
- Deverá ler as instruções antes de utilizar as ferramentas.
- Não deverá modificar nenhuma ferramenta.
- Nos carro de ferramentas, nunca deverá abrir mais do que uma gaveta de cada vez (perigo de tombar).
- Nos carro de ferramentas, nunca deverá usar uma gaveta como escada (perigo de tombar).
- Não deverá puxar de costas o carro de ferramentas.

Ferramentas Pneumáticas

As ferramentas pneumáticas Jonnesway permitem que os operadores usufruam de uma utilização segura, um desempenho excelente e reduzidas vibrações. As seguintes instruções de segurança são para as condições normais de utilização. Antes de utilizar as ferramentas pneumáticas, deverá ler com atenção estes avisos para evitar perigos desnecessários.

• Utilizar Proteção Pessoal

Deverá usar sempre proteção (como por exemplo máscaras, óculos, auriculares, luvas, etc.) quando manusear ferramentas pneumáticas de modo a evitar ferimentos.

• Evitar Danos Causados por Vibrações ou Movimentos de Trabalho Repetitivos

A exposição prolongada a vibrações ou a movimentos de trabalho repetitivos poderá ser prejudicial. Se sentir formigueiro, entorpecimento, desconforto ou dor, deverá parar de utilizar a ferramenta de imediato. Os operadores deverão seguir sempre as instruções a seguir indicadas:

- Utilizar as pegadas do equipamento para garantir a sua rigidez e eficiência.
- Manter os pulsos o mais direito possível.
- Evitar movimentos muito repetitivos das mãos e pulsos.
- Manter as mãos e o corpo quentes e secos.
- Evitar a exposição contínua a vibrações por períodos muito prolongados.

• Evitar os Perigos do Ar Comprimido

- O ar sob pressão pode causar ferimentos. Por favor, observar as seguintes instruções de segurança para garantir um ambiente de trabalho seguro.
- Não direcionar o tubo do ar para si ou para outros. Deverá afastar o escape do ar de si próprio ou de outros.
- Antes de utilizar a ferramenta pneumática, verificar a existência de tubos e acessórios danificados ou soltos.
- Deverá desligar a ferramenta sempre que estiver a substituir acessórios, definir o aperto, efetuar reparações ou não estiver a ser utilizada.
- Deverá manter sempre a pressão do ar nos valores aconselhados, já que a utilização das ferramentas fora destes valores diminuirá o seu rendimento e a vida útil da ferramenta.
- Não ligar ferramentas pneumáticas a tomadas elétricas.
- Quando utilizar uniões universais de torção, deverão ser sempre instalados pinos/garfos de bloqueio para evitar que os tubos se desliguem acidentalmente.

• Evitar Perigos Adicionais

- Escorregadelas, tropeções e quedas são a causa principal de ferimentos e morte em acidentes de trabalho.
- Deverá ter cuidado com o excesso de tubos e cabos existentes na área de passagem ou na superfície de trabalho.
- Os operadores e técnicos de manutenção deverão estar fisicamente aptos para efetuar as suas tarefas e suportar o volume, peso e potência da ferramenta.
- Deverão ser utilizadas proteções nas rebarbadoras para reduzir o risco de cortes e escoriações devido às rebarbas.

Sistema Pneumático de Alimentação

- ① Filtro
- ② Drenagem
- ③ Secador de Ar
- ④ Depósito de Ar
- ⑤ Compressor de Ar
- ⑥ Filtro Regulador - Lubrificador

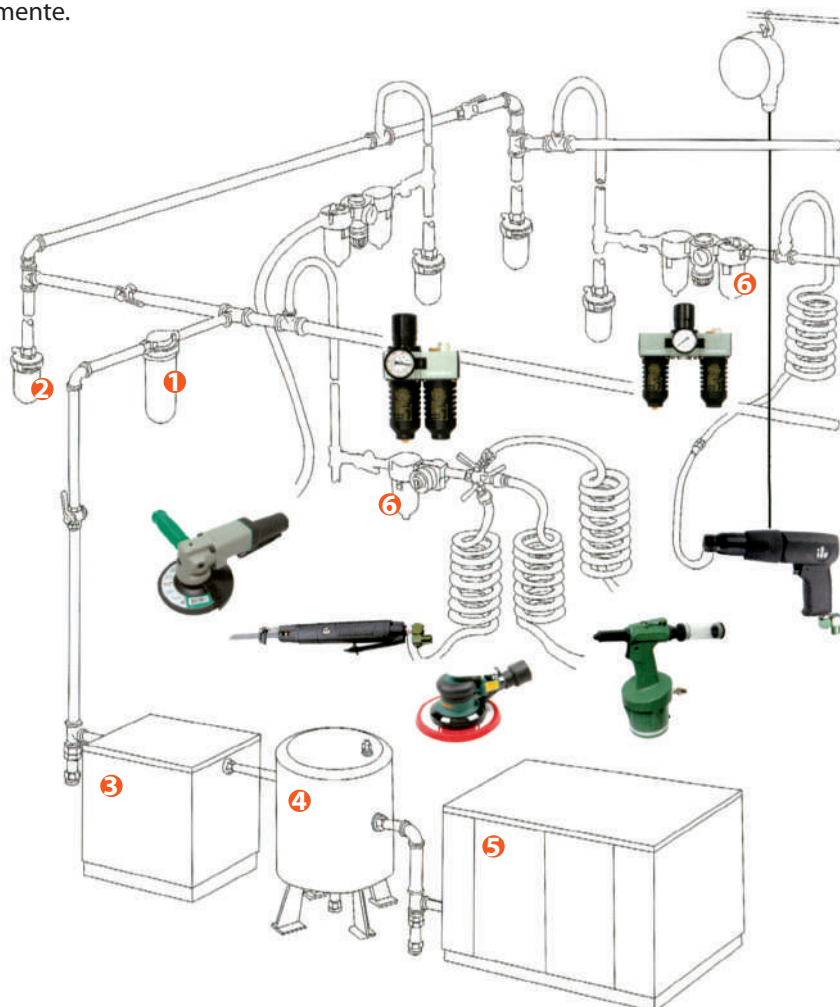

Recomendações de Manutenção

Quando ligar a ferramenta pneumática à rede de ar comprimido, deverá certificar-se que a pressão de alimentação desta deverá ser de 6.2kg/cm² (90PSI), já que se esta for demasiado elevada poderá danificar a ferramenta e se for demasiado baixa influenciará o funcionamento da mesma, reduzindo a sua vida útil.

- É recomendável a instalação dos filtros reguladores-lubrificadores adequados à ferramenta pneumática em uso. A entrada do ar deverá ter óleo lubrificante apropriado, de modo a lubrificar o motor interno da ferramenta. (Colocar um papel branco na saída do ar para verificar se existe uma sujidade gordurosa, que indique a existência de óleo suficiente).
- A entrada de ar não deverá ter água. Se tal ocorrer, recomenda-se a verificação ou instalação de um secador de ar.
- Não deverá desmontar a ferramenta, pois poderá danificá-la e afetar a segurança do utilizador.
- Mesmo que a ferramenta possua danos menores ou não efetue as funções indicadas pelo fabricante, não deverá utilizá-la até que seja inspecionada.
- Para manter o bom desempenho da ferramenta, deverá efetuar verificações regulares (semanalmente) e manutenções preventivas e lubrificações (adicionar massa lubrificante às peças rotativas e óleo lubrificante no motor).
- Sempre que utilizar as ferramentas pneumáticas deverá cumprir com as normas de segurança e instruções de funcionamento (quer aplicáveis à proteção do utilizador, quer à correta utilização da ferramenta).
- É essencial escolher as ferramentas certas e adequadas para o trabalho a realizar, já que se a ferramenta tiver uma potência muito elevada, poderá causar danos na peça em que está a trabalhar e se tiver pouca potência, poderá ficar danificada.

Condições Gerais de Garantia

A ferramenta manual e pneumática Jonnesway é fabricada com os mais elevados padrões de qualidade, mas é, para todos os efeitos, uma ferramenta de desgaste. É pois normal que a ferramenta sofra alteração de algumas características físicas durante o período de utilização, mesmo quando usada em condições normais.

Assim, a garantia da ferramenta fica dependente do conjunto das seguintes condições gerais:

- Para ferramentas manuais é oferecida uma garantia de “vida útil”, garantia esta que cobre defeitos de materiais e fabrico. Entende-se como “vida útil” o período de tempo de vida expectável para a peça de ferramenta em causa, desde que utilizada sempre nas condições normais de utilização e para as quais foi concebida.
- A gama de ferramentas pneumáticas e ferramentas de medição estão excluídas do ponto anterior. Os produtos foram desenhados e fabricados para uso profissional. O período de garantia é de um ano (12 meses) para uso profissional e de dois anos (24 meses) para uso particular. O período de garantia inicia-se à data da aquisição. Esta data deve ser verificada mediante a fatura de aquisição.
- Qualquer produto que tenha sido utilizado ou mantido de forma incorreta, que tenha sofrido um desgaste devido a uma utilização inadequada ou que tenha sido sujeito a alterações não autorizadas, não está coberto pela garantia.
- A ausência de manutenção preventiva ou a utilização de ar comprimido com pressão e lubrificação desajustadas são motivo para a perda imediata da garantia.



JONNESWAY®

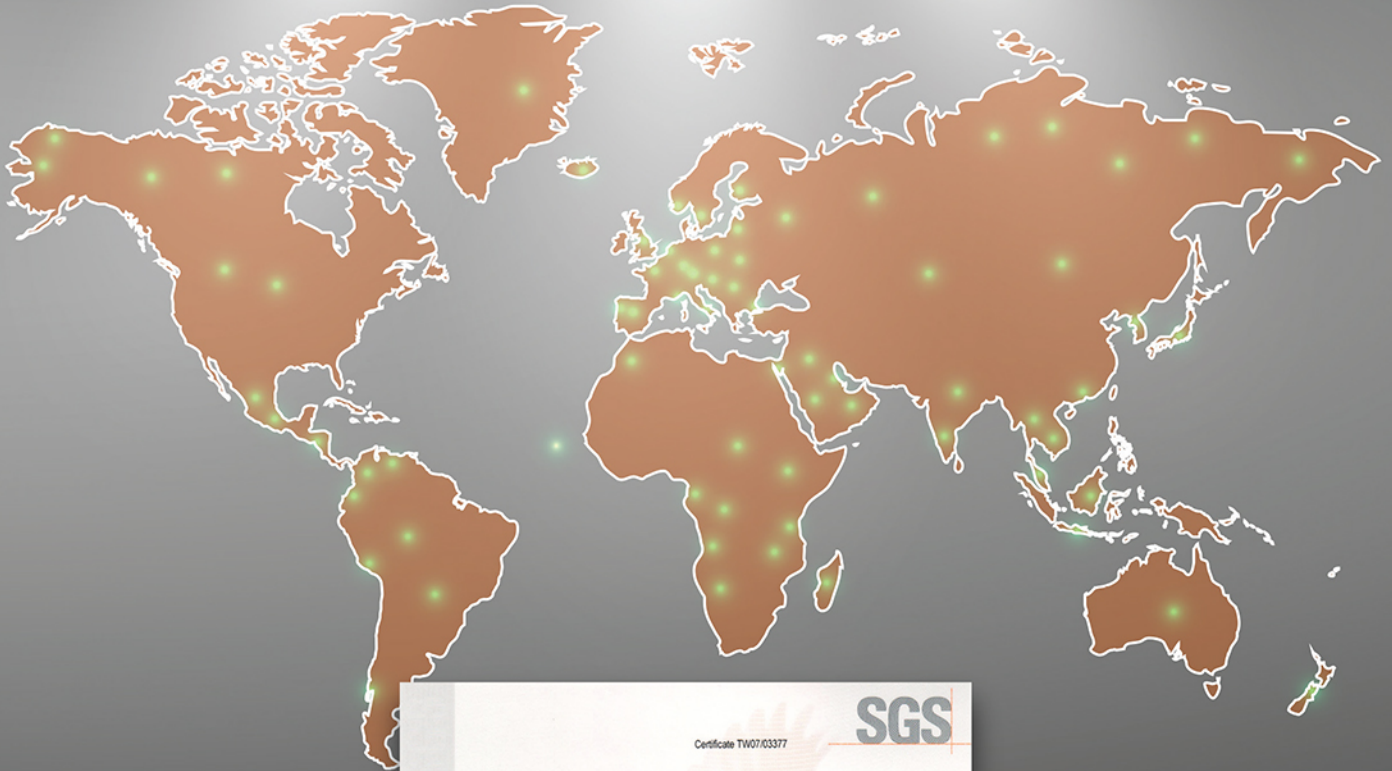

Certificate TW07/03377

The management system of

JONNESWAY ENTERPRISE CO., LTD.

6F 9, No. 51, Sec. 2, Keelung Rd., Taipei City

has been assessed and certified as meeting the requirements of

ISO 9001:2015

For the following activities

Design and trading management of JONNESWAY brand of professional hand tools, pneumatic tools, automobile repair tools, garage equipment and working machines.

This certificate is valid from 14 February 2019 until 14 February 2022 and remains valid subject to satisfactory surveillance audits. Recertification audit due a minimum of 60 days before the expiration date. Issue 6. Certified since 14 February 2007

Authorized by



SGS United Kingdom Ltd
Rosemead Business Park, Epsom Road, Chislehurst, Kent, UK
t +44 (0)181 300-6000 f +44 (0)181 300-6000 www.sgs.com

HC SGS 9001 2015 0818
Page 1 of 1







This document is issued by the Company subject to its General Conditions of Certificate. Services available at www.sgs.com/terms_and_conditions.htm. Information is given in the language of the application and jurisdiction of the certifying body. The accuracy of the information may be verified at http://www.sgs.com/certificates_and_products/certified_directories. Any professional deviation, change or modification of the content or appearance of this document is invalid and a reference may be made to the latest version of the document.



JONNESWAY®

Ferramentas Profissionais Manuais e Pneumáticas



GAMA DE FERRAMENTAS



CARROS, ARMÁRIOS
E COMPOSIÇÕES



FERRAMENTA MANUAL
PARA USO GERAL



FERRAMENTA ISOLADA 1 000V



FERRAMENTA DEDICADA
AO RAMO AUTOMÓVEL



FERRAMENTA PARA
VEÍCULOS PESADOS



FERRAMENTA ESPECIAL
PARA MOTOS



FERRAMENTA PARA
PINTURA E CHAPARIA



FERRAMENTA PNEUMÁTICA



Importador para Portugal, França, Espanha, Angola e Cabo Verde

Distribuidor / Revendedor



Lusilectra
Salvador Caetano

Rua Engº Ferreira Dias, 953/993 • 4100-247 Porto • Portugal
Tel. +351 226 198 750 • Email. equip.oficina@lusilectra.pt
www.lusilectra.com • www.jonneswaytools.com

